

OMNIA VOCO® 8

Powerful, networked mic processing for your entire facility.



USER'S MANUAL

For part numbers: 2001-00396-000, 2001-00421-000, 2001-00422-000, 2001-00423-000

VOCO 8 Software Version 1.15 Remote Gateway Version 3.5.1



Notices and Cautions

CAUTION:

The installation and service instructions in this manual are for use by qualified personnel only. To avoid electric shock, do not perform any servicing other than that contained in the operating instructions unless you are qualified to do so. Refer all servicing to qualified personnel.

This instrument has an autoranging line voltage input. Ensure the power voltage is within the specified range of 100-240v. The ~ symbol, if used, indicates an alternating current supply.



This symbol, wherever it appears, alerts you to the presence of uninsulated, dangerous voltage inside the enclosure – voltage which may be sufficient to constitute a risk of shock.



This symbol, wherever it appears, alerts you to important operating and maintenance instructions. Read the manual.

CAUTION: DOUBLE POLE/NEUTRAL FUSING

The instrument power supply incorporates an internal fuse. Hazardous voltages may still be present on some of the primary parts even when the fuse has blown. If fuse replacement is required, replace fuse only with same type and value for continued protection against fire.

WARNING:

The product's power cord is the primary disconnect device. The socket outlet should be located near the device and easily accessible. The unit should not be located such that access to the power cord is impaired. If the unit is incorporated into an equipment rack, an easily accessible safety disconnect device should be included in the rack design.

To reduce the risk of electrical shock, do not expose this product to rain or moisture. This unit is for indoor use only.

This equipment requires the free flow of air for adequate cooling. Do not block the ventilation openings in the top and sides of the unit. Failure to allow proper ventilation could damage the unit or create a fire hazard. Do not place the units on a carpet, bedding, or other materials that could interfere with any panel ventilation openings.

If the equipment is used in a manner not specified by the manufacturer, the protection provided by the equipment may be impaired.

WARNUNG:

Die Installations- und Serviceanleitung in diesem Handbuch ist für die Benutzung durch qualifiziertes Fachpersonal. Um Stromschläge zu vermeiden führen Sie keine andere Wartung durch als in dieser Betriebsanleitung ausgeführt, es sei denn Sie sind dafür qualifiziert. Überlassen Sie alle Reparaturarbeiten qualifiziertem Fachpersonal.

Dieses Gerät hat eine automatische Bereichseinstellung der Netzspannung.

Stellen Sie sicher, dass die verwendete Netzspannung im Bereich von 100-240V liegt.

Das Symbol ~, falls verwendet, bezeichnet eine Wechselstromversorgung.



Dieses Symbol, wo immer es auftaucht, macht Sie auf nicht isolierte, gefährliche elektrische Spannung (ausreichend um einen Stromschlag hervorzurufen) innerhalb des Gehäuses aufmerksam. Spannungen.



Dieses Symbol, wo immer es auftaucht, weist Sie auf wichtige Bedienungs- und Wartungsanleitung hin. Lesen Sie die Bedienungsanleitung.

ACHTUNG: ZWEIPOLIGE ABSICHERUNG / NULLEITER ABSICHERUNG

Das Netzteil des Gerätes hat eine interne Sicherung eingebaut. Auch wenn die Sicherung durchgebrannt ist, können auf einigen primären Bauteilen noch gefährliche Spannungen vorhanden sein. Wenn ein Austausch der Sicherung erforderlich ist, ersetzen Sie die Sicherung nur mit gleicher Art und Wert für den kontinuierlichen Schutz gegen Feuer.

WARNUNG:

Das Gerätenetzkabel ist die Haupttrennvorrichtung. Die Steckdose sollte sich in der Nähe des Gerätes befinden und leicht zugänglich sein. Das Gerät sollte nicht so angeordnet sein, dass der Zugang zum Netzkabel beeinträchtigt ist. Wird das Gerät in ein Rack eingebaut, sollte eine leicht zugängliche Sicherheitstrennvorrichtung in den Rack-Aufbau mit einbezogen werden.

Um die Gefahr von Stromschlägen zu verringern, darf dieses Produkt nicht Regen oder Feuchtigkeit ausgesetzt werden. Dieses Gerät ist nur für die Benutzung im Innenbereich. Dieses Gerät erfordert freie Luftzirkulation für eine ausreichende Kühlung. Blockieren Sie nicht die Lüftungsschlitze auf der Geräteoberseite und den Seiten des Gerätes. Unzureichende Belüftung kann das Gerät beschädigen oder Brandgefahr verursachen. Platzieren Sie das Gerät nicht auf einem Teppich, Poster oder andere Materialien welche die Lüftungsöffnungen beeinträchtigen könnten.

Wird das Gerät anders als in der, vom Hersteller angegebenen Weise verwendet, kann der, durch das Gerät gegebene Schutz beeinträchtigt werden.

USA CLASS A COMPUTING DEVICE INFORMATION TO USER. WARNING:

This equipment generates, uses, and can radiate radio-frequency energy. If it is not installed and used as directed by this manual, it may cause interference to radio communication. This equipment complies with the limits for a class a computing device, as specified by fcc rules, part 15, subpart j, which are designed to provide reasonable protection against such interference when this type of equipment is operated in a commercial environment. Operation of this equipment in a residential area is likely to cause interference. If it does, the user will be required to eliminate the interference at the user's expense. Note: objectionable interference to tv or radio reception can occur if other devices are connected to this device without the use of shielded interconnect cables. Fcc rules require the use of shielded cables.

CANADA WARNING:

"This digital apparatus does not exceed the class a limits for radio noise emissions set out in the radio interference regulations of the Canadian department of communications."

"Le présent appareil numérique n'émet pas de bruits radioélectriques dépassant les limites applicables aux appareils numériques (de class a) prescrites dans le règlement sur le brouillage radioélectrique édicté par le ministère des communications du Canada."

CE CONFORMANCE INFORMATION:

This device complies with the requirements of the EEC council directives:

- ◆ 93/68/EEC (CE MARKING)
- ◆ 73/23/EEC (SAFETY – LOW VOLTAGE DIRECTIVE)
- ◆ 89/336/EEC (ELECTROMAGNETIC COMPATIBILITY)

Conformity is declared to those standards: EN50081-1, EN50082-1.

VOCO 8 MANUAL

© 2014-2016 TLS Corp. Published by Omnia Audio/TLS Corp. All rights reserved.

TRADEMARKS

Omnia Audio, the Omnia logo and VOCO 8 are trademarks of TLS Corp. All other trademarks are the property of their respective holders.

NOTICE

All versions, claims of compatibility, trademarks, etc. of hardware and software products not made by Omnia Audio which are mentioned in this manual or accompanying material are informational only. Omnia makes no endorsement of any particular product for any purpose, nor claims any responsibility for operation or accuracy. We reserve the right to make improvements or changes in the products described in this manual which may affect the product specifications, or to revise the manual without notice.

WARRANTY

This product is covered by a five year limited warranty, the full text of which is included in this manual.

UPDATES

The operation of VOCO 8 is determined largely by software. We routinely release new versions to add features and fix bugs. Check the Omnia Audio web site for the latest. We encourage you to sign-up for the email notification service offered on the site.

FEEDBACK

We welcome feedback on any aspect of VOCO 8, or this manual. In the past, many good ideas from users have made their way into software revisions or new products. Please contact us with your comments.

SERVICE

You must contact Omnia before returning any equipment for factory service. We will need your unit's serial number, located on the back of the unit. Omnia will issue a return authorization number, which must be written on the exterior of your shipping container. Please do not include cables or accessories unless specifically requested by the Technical Support Engineer. Be sure to adequately insure your shipment for its replacement value. Packages without proper authorization may be refused. US customers, please contact Omnia Technical Support at +1-216-622-0247. All other customers should contact local representative to make arrangements for service.

WE SUPPORT YOU...

BY PHONE / FAX:

- ◆ You may reach our 24/7 Support team anytime around the clock by calling +1-216-622-0247.
- ◆ For billing questions or other non-emergency technical questions, call +1-216-241-7225 between 9:30 am to 6:00 PM, USA Eastern time, Monday through Friday.
- ◆ Our Fax number is +1-216-241-4103.

BY E-MAIL:

- ◆ Technical support is available at support@Telosalliance.com.
- ◆ All other questions, please email inquiry@Telosalliance.com.

VIA WORLD WIDE WEB:

The Omnia Audio web site has a variety of information which may be useful for product selection and support. The url is www.Telosalliance.com.

REGISTER YOUR PRODUCT

Did you know that all Telos Alliance products come with a 5-Year Warranty? Take a moment to activate your coverage online at <http://telosalliance.com/product-registration/>.

OMNIA AUDIO

1241 Superior Avenue E.
Cleveland, OH., 44114 USA

+1-216-241-7225 (phone)

+1-216-241-4103 (fax)

+1-216-622-0247 (24/7 technical support)

support@Telosalliance.com

Inquiry@Telosalliance.com

	<i>A Letter from our CEO, Frank Foti</i>	VIII
Intro	<i>This Manual (Or: I don't have time to read this thing!)</i>	IX
1	<i>The Omnia VOCO® 8 Story</i>	1
2	<i>A few words about Livewire+/AES67 and Audio over IP</i>	3
3	<i>Installation</i>	6
4	<i>Front Panel Interface</i>	12
5	<i>Remote Gateway</i>	21
6	<i>User Account Overview</i>	24
7	<i>"Live" Account</i>	26
8	<i>"Admin" Account</i>	35
9	<i>"Studio" Account</i>	65
10	<i>Navigating the "Studio" interface</i>	85
11	<i>Session and Preset Management</i>	90
12	<i>"Preset Settings" Tab</i>	102
13	<i>Adjusting Processing Parameters</i>	104
14	<i>Factory Presets</i>	120
15	<i>Frequently Asked Questions (FAQ)</i>	123
16	<i>Specifications</i>	125
17	<i>Live Preset Adjustment</i>	127

War of the Waves

Dear Valued Customer,

It's with great pride and a tip of the hat to an incredible team that I congratulate you on your new Telos Alliance product. Everything we do here at the radio division of the Telos Alliance is with one end goal in mind: To help broadcasters declare victory in extremely competitive environments. By purchasing this product from us, in essence, you have declared war on your competition.

After all, the majority of Telos Alliance employees were broadcasters themselves once, and the products we've developed over the years have been designed as solutions to specific issues faced on the front lines of our industry. We're right there in the trenches with you and have the weapons you need in your arsenal.

Telos Systems is a catalyst to out-of-this-world sound, with the most powerful and popular broadcast telephone systems in the industry; IP/ISDN codecs and transceivers; plus processing/encoding for streaming audio. We built an industry on the back of these amazing telephony systems, and they are still going strong.

While we at the Telos Alliance never forget our roots, we are also blazing trails in terms of new technologies like stream-encoding and AoIP, so that all types of broadcasters can excel in this ever-evolving digital world. **Omnia Audio** not only lets you stand out on the dial with your unique signature sound via legendary audio processors, audio codecs, and microphone processing, it lets you give your listeners a better streaming experience across devices with innovative stream encoding/processing software and hardware.

Axia Audio is a driving force behind the AES67 AoIP standard, and its networked AoIP radio consoles, audio interfaces, networked intercom, and software products continue to move AoIP adoption forward and help broadcasters streamline operations with cohesive, smart, and feature-rich AoIP ecosystems.

Last, but certainly not least, **25-Seven** has traditionally been known for its audio delays, but its Voltair watermark monitor/processor has made a name for itself more recently as the disruptive product that helped broadcasters take back their ratings and harness the true power of their listening audiences.

You work so hard on your programming day-in and day-out, it deserves technology that will optimize sound and performance at every point in the airchain and online. Armed with Telos products, you have what you need to set your competition squarely in your crosshairs.

With that, I'll leave you to prep your armaments. I hope that you will enjoy your Telos Alliance products for many years to come!

Sincerely,
Frank Foti

CEO, The Telos Alliance



About This Manual

The Obligatory “Read Me First” Section

Be honest—Show of hands. How many of you put your brand new VOCO 8 in the rack and tried to make it fly before you even picked up the Quick Start Guide, let alone this manual? Were you a bit stumped? It’s OK. Most of us get excited about a shiny new piece of gear and do the exact same thing—only to crack the manual when we reach a stumbling block, searching desperately for the answer. If that’s you, or even if *gasp* you’re reading this BEFORE you install the unit, read on!

The Omnia VOCO® 8 combines 8 studio-quality microphone preamps with up to 8 licensable channels of 3-band microphone processing (2 are included standard). Other key features include full Livewire+/AES67 Audio over IP (AoIP) connectivity, as well as analog and AES/EBU I/O, and a comprehensive IP remote control interface.

We realize that most people don’t actually LIKE reading manuals, but we’ve tried to make this one pretty straightforward.

The chapters are laid out in a logical order that (for the most part) follows the overall flow of the unit and the software. Chapters dealing with the more complex setup functions and the audio processing parameters are a bit longer than the others, but they’re still a relatively quick read.

We know you have a lot of things you could probably be doing besides reading this manual. If you REALLY don’t have time to read anything else, start with the chapters covering Installation, Front Panel Interface, and Remote Gateway. If you’re in even more of a hurry, jump straight to the Frequently Asked Questions at the end of this manual.

If after reading this manual you have any suggestions for improvement (or if you see something we might have missed) send a note to inquiry@telosalliance.com.

As always, 24/7 support is available by calling 216-622-0247. During normal business hours, call us at 216-241-7225 or e-mail support@telosalliance.com.

Happy Processing!

1 The Omnia VOCO® 8 Story



Omnia®: It Begins.

From the very moment Telos Alliance CEO and Omnia Audio founder Frank Foti unleashed some of his first sonic weapons of audio processing on the FM dial, Omnia had a singular mission: To enable radio stations to “Start Taking Hostages” when it came to their audio. This meant delivering audio that was not only LOUD but also some of the CLEAN-EST on the dial, free of distortion and other artifacts that plagued so many stations fighting the loudness war. We did what many thought was impossible at the time; increased loudness AND made the audio cleaner. Contrary to what some may believe, we aren’t simply about brute force loudness at all costs. The core passion of Omnia is to deliver audio that isn’t just HEARD but FELT!

Since those early days, Omnia has produced some of the most widely used audio processors in the industry—from the very first DSP based processor for FM that wasn’t simply trying to emulate analog processing, to the popular Omnia 6 which quickly became an industry standard, to the versatile and cost effective Omnia ONE, and now the Omnia.7, Omnia.9, and Omnia.11. They all reflect that same core passion that makes Omnia what it has become today.



Linear Acoustic®

In 2008 another group equally passionate about high quality audio on the television side of the industry, Linear Acoustic®, joined The Telos Alliance. Tim Carroll, Telos Alliance CTO and Linear Acoustic founder, along with the whole team from Linear Acoustic had developed a number of award winning products and technologies for DTV loudness management and surround sound upmixing/downmixing. This talented team worked to apply their deep knowledge base and passion for audio to the radio side of the industry. It was this partnership that brought products like the Omnia.7 to reality.



Sound4

In 2010, yet another company partnered with The Telos Alliance. Sound4, based in France, started by becoming a Livewire development partner and incorporating Livewire technology into their line of audio processing cards. The S4 team shared many of the same passions about audio as everyone else at The Telos Alliance.



The VOCO 8 is born

It was from the unique partnership of these three groups that the VOCO 8 came to be. The Omnia.S4 Voice 192 kHz 3-band 8-channel microphone processor card is at the heart of the VOCO 8, along with additional hardware and software designed by the teams from Omnia, Linear Acoustic, and Sound4. It truly was a collaborative effort by one of the largest audio processing R&D teams in the entire industry.

In VOCO 8, we have a product that reflects our passion as a company and continues the long-standing Omnia tradition.

2 A Few Words about Livewire+ and AES67

What is Livewire+™ ?



Livewire+ is the pioneering technology invented by the Telos Alliance to convey low-delay, high-reliability audio over switched Ethernet.

Introduced as Livewire™ in 2003, today's Livewire+ is AES67-compliant. That means that it complies fully with the AES67-2013 Interoperability Standard, allowing AES67 devices to connect directly to Livewire+ networks and exchange audio streams. Livewire+ is also extensible, able to incorporate future AES standards when they are ratified. Livewire+ is also backward-compatible with the RAVENNA™ networking protocol.

With Livewire+, a single Ethernet cable carries real-time uncompressed digital audio, device control messages, program associated data, and even routine network traffic. An entire facility can be wired in hours, instead of weeks. All Axia Audio studio products, and most products from other Telos Alliance brands, utilize Livewire+ networking technology. Expanding or modifying your system is simple thanks to the inherent scalability and modularity of Livewire+.

Livewire+ offers a revolutionary change in how studios can be built. But at the same time, it's a natural continuation of general trends and what you already know.

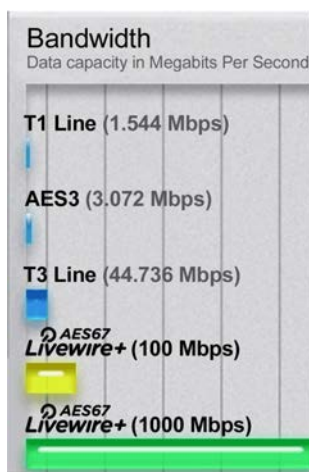

How Livewire+ works

Livewire+ has an audio advertising system. Every source has a text name and numeric ID. These are transmitted from source devices to the network. Devices that play audio build lists of all available sources from which users can select.

Using xNode audio interfaces, you enter the names of your input sources via any PC with a web browser. With playout PCs attached to the network, you open a configuration window.

Livewire+ networks employ two types of audio streams. Livestreams have small, frequent packets optimized for live audio that requires very low (circa 1 ms.) delay, for microphones and headphone audio. Standard Streams are also real-time streams, but with bigger packets, and are used for audio streams which don't require super-low latency - like audio from CD players, or that exchanged with automation system PCs. Devices that connect to Axia networks can transmit and receive both stream types; the user selects which type to generate when a device is initially configured.

A sophisticated phase-locked loop clocking system allows Livewire+ to use very small buffers for least latency and ensures that audio channels remain time-aligned (as needed for multiple mics in a studio or for TV surround-sound mixing.)

Converged Networks

An Ethernet network used for Livewire+ audio can also be shared with other data transmissions, such as file transfers and web browsing. An Ethernet system with a switch at the center may have a mix of audio nodes and normal servers, PCs, etc., because the Ethernet switch directs traffic only to where it is needed.

Even on a single link, traffic can be mixed because we use modern Ethernet's priority mechanism to be sure audio packets have first call on the link's bandwidth. A studio audio delivery system can use this capability to download an audio file from a server, for example, while simultaneously playing another audio file live.

Livewire+ maximizes the benefits of converged networking in the broadcast facility. Many stations using Livewire+ have computer data, telephone, audio, and control on a single network that uses computer industry standard wiring, spurring cost-efficiencies throughout the plant.

Audio Quality

A Livewire+ network is a controlled, high-speed environment, with no risk of audio drop-outs from network problems and plenty of bandwidth for many channels of high-quality uncompressed audio. We use studio-grade 48kHz/24-bit PCM encoding. Axia digital xNode audio adapters deliver 138dB of dynamic range, with less than 0.0002% THD. Even analog xNodes have 100dB dynamic range, < 0.005% THD, and headroom to +24dBu.

Livewire+ is standards-based

Since the very beginning, The Telos Alliance has based its AoIP networking technologies on standards. IP (Internet Protocol), the networking standard that is the underpinning of nearly all critical business networks (and of the Internet itself) is the basis for Livewire+ AoIP.

As charter members of the AES X.192 Working Group, we helped define the AES67 standard — and became the first broadcast manufacturer to become AES67 compliant.

Livewire+ is so standards-based, in fact, that your audio can even be played by PC media players that support standard protocols and uncompressed PCM audio. The Internet's IP standard for streaming media, called RTP/IP, is used for standard audio streams. RTP stands for Real-Time Protocol. It's the Internet's standard way to transport streaming audio and video, just as TCP/IP is the standard for general data.

The Gold Standard

In the decade since the introduction of Livewire+, broadcasters have adopted it at an exponential rate; AoIP has become the new standard for broadcast facilities.



Consider these facts:

- ◆ There are over 6,000 studios worldwide built with Livewire+.
- ◆ More than 5,500 networked Axia consoles are at work daily.
- ◆ Over 80 Livewire+ Partner companies provide compatible hardware and software products.
- ◆ There are more than 60,000 individual Livewire+ devices in the field.
- ◆ Livewire+ is fully compliant with the AES67 Interoperability Standard.

Impressive, no? But there are even more exciting things in the future. The Telos Alliance, with one of the largest R&D groups in broadcast, is fully committed to AoIP interoperability. We've been proponents of open standards since Day 1, freely sharing our technology with interested Hardware and Software Partners. We were charter, supporting member of the X.192 Working Group that defined the AES67 standard, and as founding members of the Media Networking Alliance, are actively engaged in work to promote and enhance standards-based AoIP networking.

3 Installation



Choosing a Location

The VOVO 8 uses 2 RU of rack space and is approximately 14 3 / 4” deep. It should mount just fine in most standard 19” equipment racks but you will want to choose a location where you can access the front panel controls and ensure that you leave enough space behind the unit to accommodate the I/O connectors. Although it is not required, we recommend that you leave 1RU above and below the unit if possible to allow air circulation.

A temperature-controlled fan on the left hand side of the unit provides cooling. This fan (while relatively quiet during normal operation) may become audible if the internal temperature of the unit begins to rise as the fan speed increases. You may want to consider mounting the unit in an equipment closet adjacent to the studio if elevated temperatures in the mounting location could cause fan noise to become an issue.



Mic/Line Inputs and Outputs

Each of the 8 analog inputs can accept either a microphone level signal (with selectable Phantom power and pad) or a line level signal. Input connections are provided through a set of Neutrik “combo” connectors (pin 2 hot; tip hot). Analog inputs and outputs are also provided on a pair of female DB25 connectors conforming to the Tascam standard pinout.

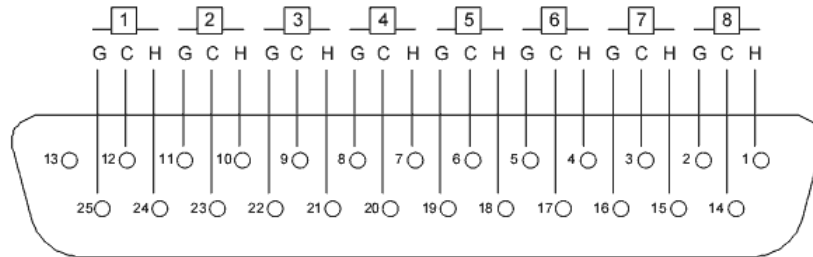

H = HOT
 C = COLD
 G = GROUND

Tascam standard DB25 pinout used for analog I/O (Female connector on chassis, male connector on cable)

Input Status Indicator LEDs

Next to each of the combo connectors is an LED that indicates the status of Phantom power and the switchable -20 dB pad. These settings are controlled through the Remote Gateway software.

CAUTION:

Ensure Phantom power is only enabled on channels where it is necessary. Damage may result to microphones or sources not designed to accept Phantom power.

- ◆ Off: Phantom power off, pad disabled
- ◆ Red: Phantom power on, pad disabled
- ◆ Green: Phantom power off, pad enabled
- ◆ Orange: Phantom power on, pad enabled

These LEDs will all briefly illuminate orange at power up but should reflect the current status once the unit is fully operational.

Note:

Later software/hardware revisions changed the designation of the "Green" LED condition to indicate whether or not a channel is licensed for audio processing. As of software version 1.15, all channels should be available for basic preamp and I/O functions, regardless of whether or not processing functions are licensed.

AES/EBU I/O

The VOCO 8 provides 4 AES/EBU inputs and outputs on a female DB25 connector conforming to the Tascam AES/EBU pinout.

Each AES/EBU interface carries 2 channels of audio—Microphones 1 and 2 will feed the left and right channels of AES/EBU output 1, and so on. If your mixer or router will not “split” left and right from an AES/EBU feed, you may wish to use only the even or odd channels.

Note that if you use a DB25 cable to directly connect this I/O to the AES/EBU DB25 port on another device, it MUST use the Tascam pinout (not Yamaha) and the cable MUST reverse the appropriate input and output pairs (input to output, output to input). Pre-manufactured cables are available which reverse the appropriate pairs and adaptors are available to convert between Tascam and Yamaha pinouts.

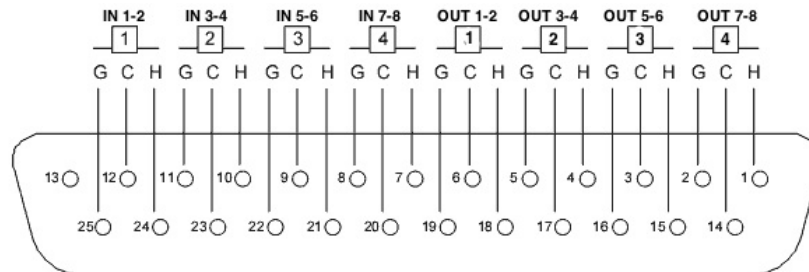

H = HOT
 C = COLD
 G = GROUND

Tascam standard AES/EBU DB25 pinout (Female connector on chassis, male connector on cable)

GPIO

A pair of 15 pin GPIO ports provides 5 opto-isolated inputs and 5 solid-state relay outputs per port. These ports are not currently implemented and are intended for future use (such as carrying GPIO traffic to and from an AoIP network).

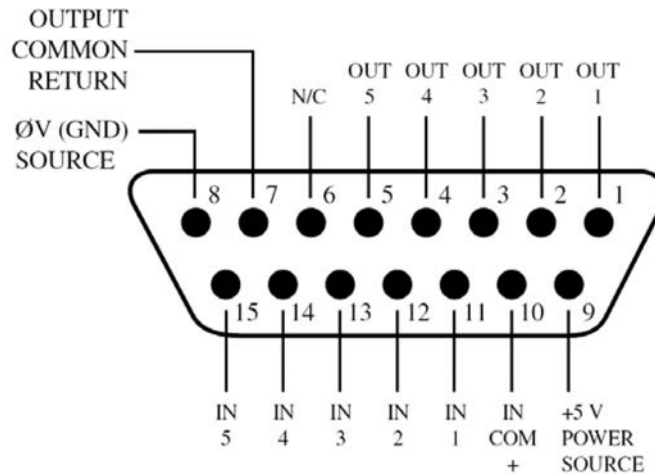
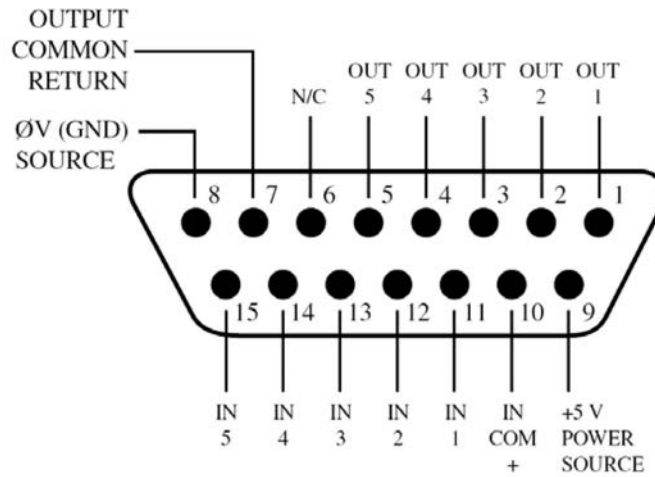

15 pin GPIO connectors using Axia pinout (Female connector on chassis, male connector on cable)

Ethernet Connections

There are two 10/100 Ethernet ports on the rear panel; one interface is for control, the second is for Livewire+/AES67 AoIP. Connect these ports to your network switches as appropriate. If you do not connect the VOCO 8 to an existing network, you will need a cable connected directly from the control port to a Windows PC for initial configuration of the unit (see the “Remote Gateway Software” section of this manual for further details).

AC Power Connections

The VOCO 8 features redundant power supplies. This is to accommodate facilities with dual power feeds to each equipment rack fed from completely independent sources. Both inputs should be connected, preferably to completely separate AC power sources such as conditioned utility power and UPS/generator, or at the very least two different circuits in a rack. While the unit will still function with only one power supply connected, an error message will be displayed on the LCD and in the remote software.

4

Front Panel Interface



Power LED

A (very stylish) blue LED in the lower left hand corner of the front panel indicates that AC power has been applied to one or both power supplies. There is no power switch. If this LED does not illuminate after you've plugged in the power cords (on both ends), ensure that the AC outlets are actually functional. If the outlets are providing power, try a different set of power cords. Power cords don't generally fail, but stranger things have happened. If you've verified that it's plugged in, tried multiple power cords, and the outlets are providing power but the unit still won't power up, contact The Telos Alliance for further instructions. We don't see very many dead units or outright power supply failures (let alone two in a single unit) but perhaps it was something you said while putting the unit in the rack. Try to be nicer next time.

LCD

What piece of broadcast equipment would be complete without a shiny front panel display? The VOCO 8 is no exception. A 4.3" LCD (in combination with the navigation control) provides access to preset selection, unit status, and basic configuration parameters (not to mention a very cool VOCO 8 screen saver). Please note—this is NOT a touchscreen. Don't poke. It isn't polite.

USB Port

The front panel USB port is primarily used for system software updates, but can also be used with a USB keyboard for entering preset titles or configuration information. It's also a handy place to charge your phone or attach a USB powered light.

A note about software updates:

Occasionally we may release software updates for the VOCO 8. Visit the Omnia VOCO 8 page at <http://www.telosalliance.com/Omnia/Omnia-Voco-8> to check for the latest version. As of this writing, the latest software version is 1.15. Once downloaded, place the update file in the root directory of a FAT16, FAT32, or NTFS formatted USB drive. When the USB drive is connected to the VOCO 8, it should detect the update file and prompt you to select it for installation. If there are multiple update files on the USB drive, they will all appear in the list. The default password when prompted (unless it has been changed) is admin. Do not roll back to an older version unless directed by Telos Alliance technical support.

Navigation Control

Next to the LCD is a combination rotary encoder, navigation joystick, and pushbutton control. While it may seem complicated at first with so many functions in a single control, navigation is actually very straightforward once you start exploring the front panel interface.

- ◆ Slightly press the control up, down, left, or right to move around the interface. The highlighted item will have a white frame surrounding it.
- ◆ Press the control like a pushbutton to select the highlighted item.
- ◆ In some screens (generally sub-menus) you will need to rotate the control to choose values or menu items and then press to select.



By default, the LCD will display all 8 channels and their selected processing presets (if licensed). Highlight a channel and select it to choose the preset assigned to that channel. While the preamps are active on all 8 channels, presets can only be loaded on channels licensed for processing. The “More...” button at the top allows navigation to system configuration parameters and other information. “Back” will return to the main screen.

Headphones

Any processor input or output (in addition to the four internal mix buses) can be routed to the front panel headphone jack. Use the knob above the headphone jack to control the volume. To select the feed to the headphone jack, navigate to the “More...” menu from the main screen. Once in the “More...” menu, select “Headphone”. Select the source that you wish to monitor. Select “Back” to return to the main screen.



IP Configuration

Important:

While the unit can be controlled directly from the front panel using presets, you will not be able to access most of the more detailed control functions (including gain, pad, or Phantom power). You will need to configure the unit's "Control" IP address, the "AES67" IP address (if using AoIP), and download the "Remote Gateway" software.

Configuring the "Control" IP address

From the main screen, select “More...” then select “Control IP”. By default, DHCP is enabled and the unit may have already pulled an IP address from the network if a DHCP server is available. If you wish to assign a static IP address (recommended), select DHCP, then select “Off”. Change the hostname, IP address, subnet mask, gateway address, DNS servers, and broadcast address as appropriate. The broadcast address will be x.x.x.255 where x.x.x are the first three octets of your IP network address block (i.e. if the IP address is 192.168.1.10, the broadcast address will be 192.168.1.255).

If you are using an Ethernet cable directly between a PC and the VOCO 8 for configuration, manually set both the PC and the VOCO 8 to different addresses in the same subnet using the same subnet mask (gateway and DNS are not necessary). Windows may also automatically assign the PC an address of 169.254.x.x if it is set for DHCP and unable to reach a DHCP server. Either set the VOCO 8 to an IP address from the same subnet, or turn off DHCP on the PC and configure a new static IP address. Both ends must have IP addresses in the same subnet when connected directly together. Continue scrolling to the “Display Only” section of the menu to verify the settings.

Note:

It is not necessary to use a crossover cable to connect directly between the VOCO 8 and a PC. The Ethernet ports will automatically detect a standard or crossover cable.

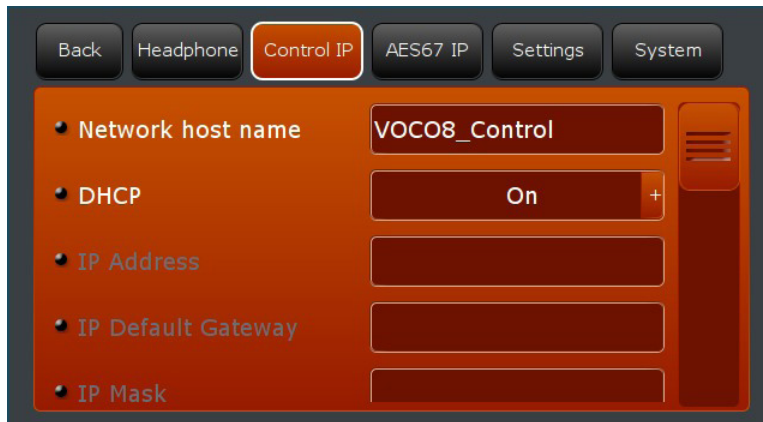

Configuring the “AES67” IP address

If you plan to use the AoIP features of the VOCO 8, you will need to configure the “AES67” IP address—or at the very least disable DHCP to eliminate the error message if you don’t plan to use AoIP. From the “More...” menu, navigate to “AES67 IP”. As with the “Control IP”, turn DHCP on or off as necessary, change the hostname, IP address, subnet mask, gateway address, DNS servers, and broadcast address as appropriate. Continue scrolling to the “Display Only” section of the menu to verify the settings. All other AoIP settings are performed within the “Remote Gateway” software.

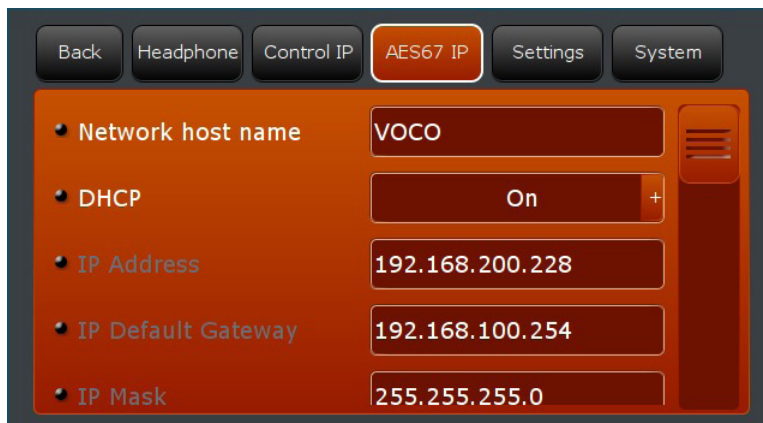

Front Panel Display Settings

The behavior and layout of the front panel display screen can be changed by navigating to the “settings” menu of the front panel. This menu also allows you to set the user (front panel lock) and admin passwords. By default, there is no front panel lock password, and the admin password is *admin*.

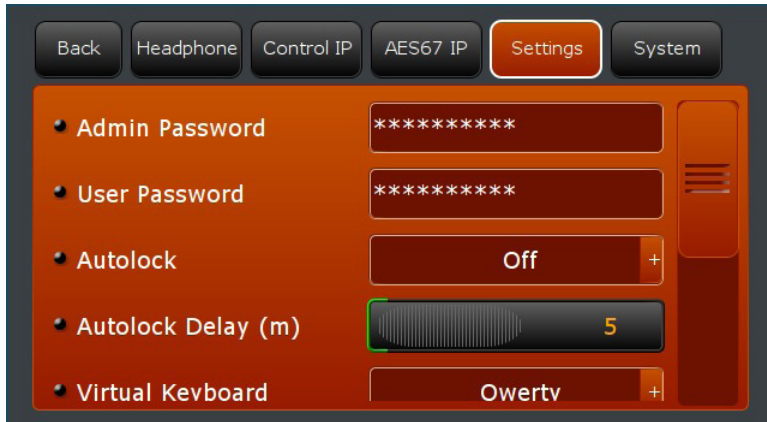

Admin Password

Allows front panel access to user controls and administrative functions such as setting IP addresses. The default password is *admin*. A front panel password would be requested if “Front Panel Auto Lock” is on. The admin password is also requested when applying a software update from the front panel via USB. The currently set password (if any) can be removed by clearing this field.

User Password

Allows front panel access only to user controls such as preset and session selection, and headphone output. There is no default password. A front panel password would be requested if “Front Panel Auto Lock” is on. The currently set password (if any) can be removed by clearing this field.

Autolock/Autolock Delay

Controls whether or not the front panel is automatically locked after the specified period of time. If Auto Lock is “Off” the value for Delay is ignored and the front panel will not automatically lock.

Virtual Keyboard

Selects between QWERTY or AZERTY layout for the on-screen keyboard.

VU Meter Speed (%)

This value controls the speed of the onscreen metering and is expressed in percent. Higher numbers will result in faster metering, though the default of 25% is generally sufficient.

Display Configuration

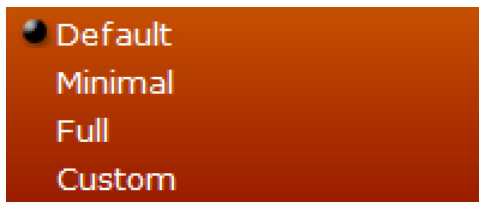

Selects which controls and indicators are displayed for each channel.

Default



Displays preset selection controls and channel names.

Minimal



Only displays preset selection controls without channel names.

Full



Displays channel names with all available metering and controls, including input and output levels, De-Esser and Noise Gate LEDs, Preset Selection, and Mute.

Custom

When “Custom” is selected, several additional setup options appear which allow hiding or showing each display element individually. In this example, the mute controls are hidden.

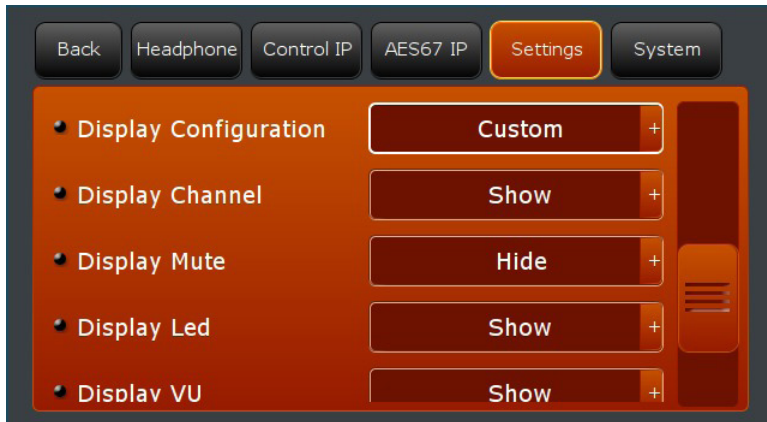

Screensaver

Enables or disables the VOCO 8 screen saver on the front panel LCD and sets the delay before activation.

System Menu

Displays the current software version, VOCO 8 Serial number, MAC addresses, and number of channels with processing licensed. This screen also allows basic system maintenance functions.

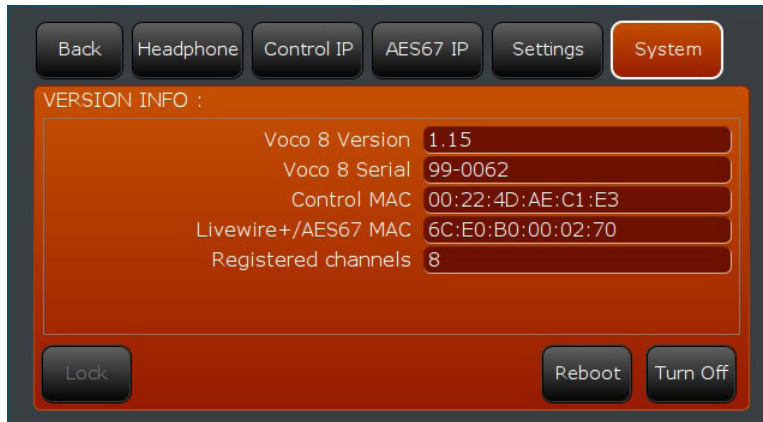

Lock

Locks the front panel if a "user" password is set. If no user password is set, this control is greyed out.

Reboot

Performs an orderly reboot of the VOCO 8. Audio interruption would be minimal (if any).

Turn Off

Performs an orderly SHUTDOWN of VOCO 8. **THIS WILL TAKE YOU OFF THE AIR!**

5

Remote Gateway

In order to configure the vast majority of the settings on the VOCO 8, you will need to download the “Telos Alliance Remote Gateway Installer”. A link to download this software and review compatibility information is available from <http://www.telosalliance.com/Omnia/Omnia-Voco-8>.

Installing Remote Gateway

When installing the software, it will prompt you to ask which components you wish to install. The “server” and “driver” components can be de-selected. Only the actual “Remote Gateway” component is necessary for use with VOCO 8.

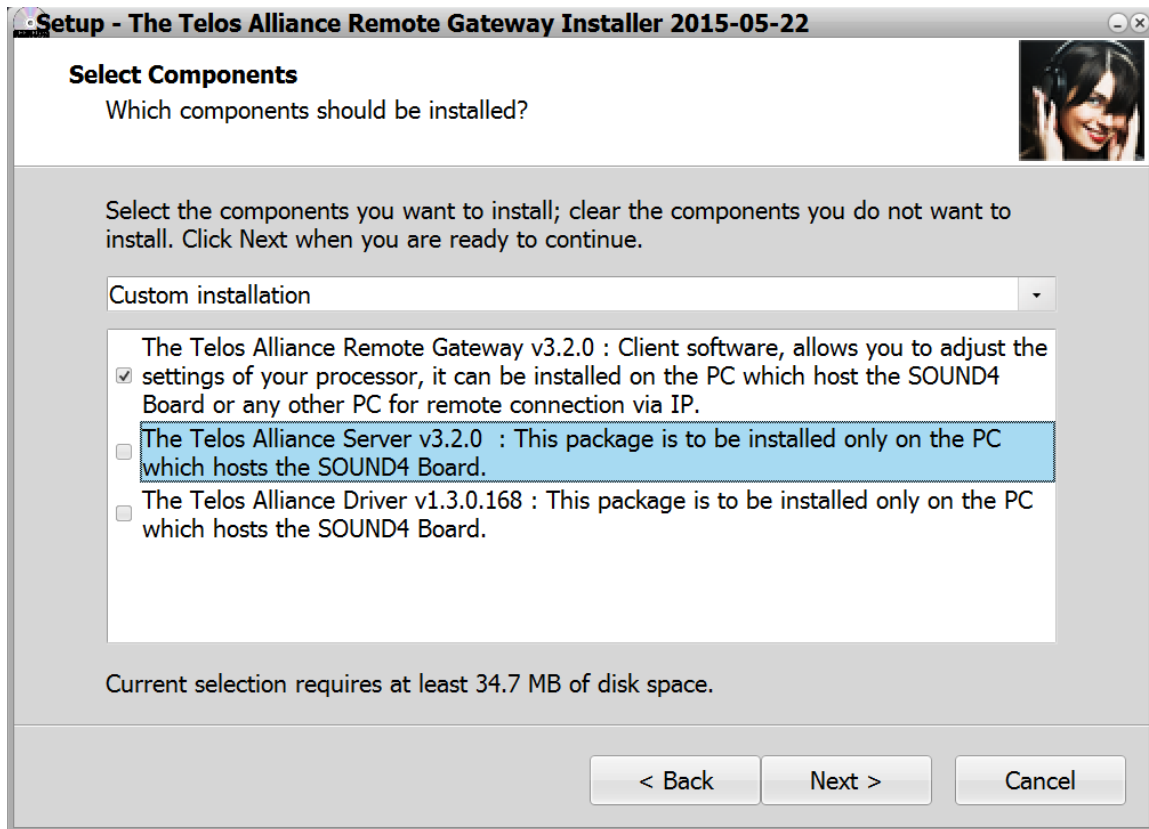

Adding the VOCO 8 to Remote Gateway

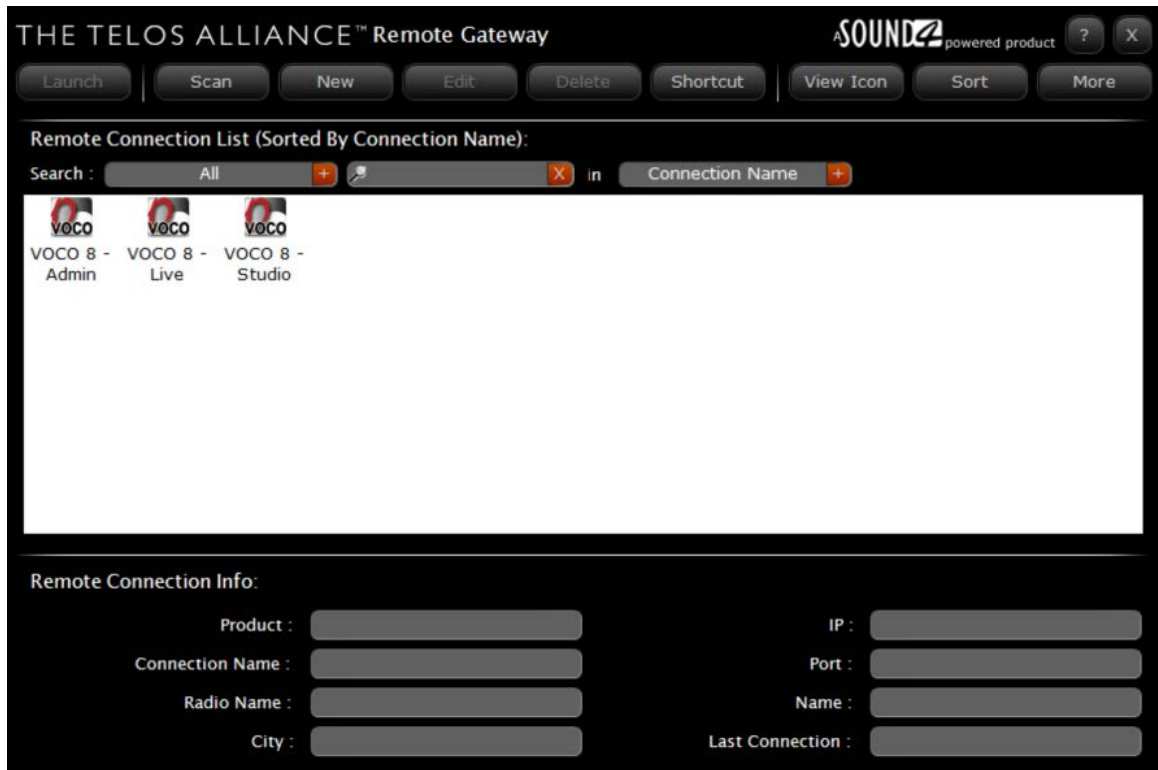

Once Remote Gateway is installed, you will need to add the VOCO 8 to the list of connections in Remote Gateway. Scan for units on the network by clicking “Scan”.

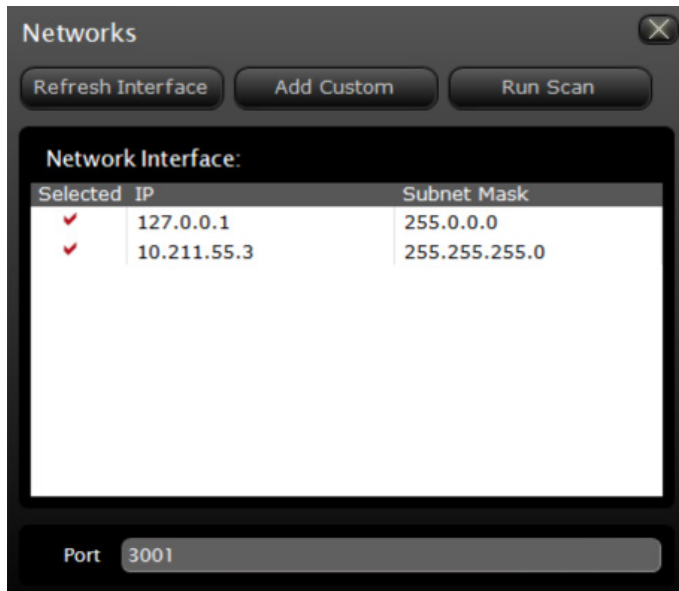

Select the interface attached to the same network as the VOCO 8 and click “Run Scan”. You can also add an IP address block not listed by clicking “Add Custom”. The default port for Remote Gateway communications with the VOCO 8 is 3001 and should only be changed if necessary. When the scan is complete, it should detect the VOCO 8. There will be multiple entries displayed for a single VOCO 8—this is due to the fact that there are multiple security levels and logins. You will need all three of them added to Remote Gateway.

If for some reason the VOCO 8 does not appear after scanning the network (due to firewall configuration, or for some other reason) you may need to add it manually. Click on “New” in the main Remote Gateway window.

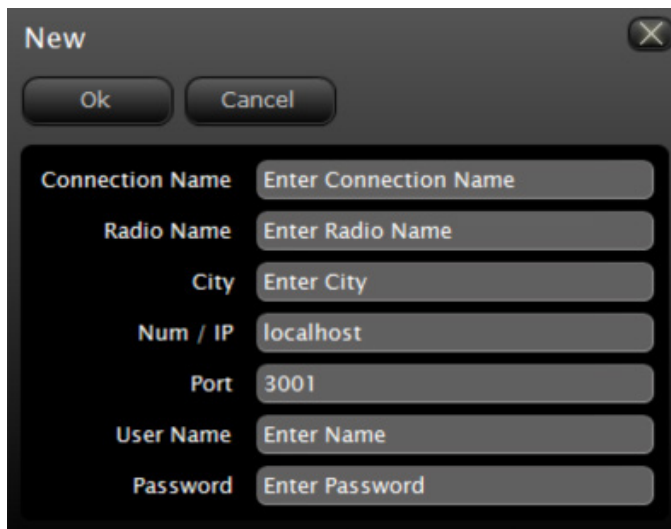

Enter something useful in the “Connection Name”, “Radio Name” and “City” fields. Enter the VOCO 8 “Control IP” address in the “Num / IP” field. Finally, enter the user name and password for the account this connection should use. Create one connection entry for each of the three default user names (described in the following chapter).

6

User Account Overview

User Names and Access Levels

Important:

There are three default user accounts on the VOCO 8. Each has a VERY different purpose. If you use the wrong one you will likely not find the controls you are looking for.

Admin

Used for managing user and studio rights, as well as certain global configuration settings. The default password for the admin account is admin.

The screenshot shows the Omnia Voco 8 web interface. At the top, there's a navigation bar with the 'Omnia Voco 8' logo and several control buttons like 'In', 'Out', 'SOUND', 'Setup', and 'About'. Below the navigation bar, there's a section titled 'IMPORTANT NOTICE' with a warning icon. The notice explains that the user is in 'User Administrator' mode and lists two other accounts: 'Studio' and 'Live'. It provides instructions on how to create new connections for these accounts using the 'Telos Remote Gateway' screen. A 'New' dialog box is open, showing fields for 'Connection Name', 'Radio Name', 'City', 'Num / IP', 'Port', 'User Name', and 'Password'. The 'User Name' field is pre-filled with 'studio or live'. To the right of the dialog box, there are instructions on how to access the Studio and Live modes. At the bottom of the notice, there's a gear icon and the text 'Rights management and resource assignment is carried out in "User Administrator" mode...'

IMPORTANT NOTICE

You are connected to this processor in "User Administrator" mode. By default, during the installation we created two other accounts:

- **Studio:** Through this account you will have access to the whole settings (except Access Rights, Resource Assignment and Board Ethernet configuration).
- **Live:** This account is a restricted mode intended to be used in "live" application, it only allows reloading Presets and Sessions. No backup is allowed in this mode.

To access the **Studio** and **Live** accounts, you will have to create two new connections to your processor. To do this, run the **Telos Remote Gateway**, you will get the **Telos Remote Gateway** screen. Click on "New" then fill in the various fields to create the different accounts...

New

Ok Cancel

Connection Name Studio 1

Radio Name Radio Plus

City Paris

Num / IP localhost

Port 3001

User Name studio or live

Password Enter Password

To access the Studio mode :

- In **User Name**, fill in "Studio".
- In **Password**, leave it empty because no password is configured by default.

To access the Live mode :

- In **User Name**, fill in "live".
- In **Password**, leave it empty because no password is configured by default.

Rights management and resource assignment is carried out in "User Administrator" mode...

Studio

This account is where the vast majority of configuration will take place including all I/O configuration, processing settings, and preset management. There is no default password set.

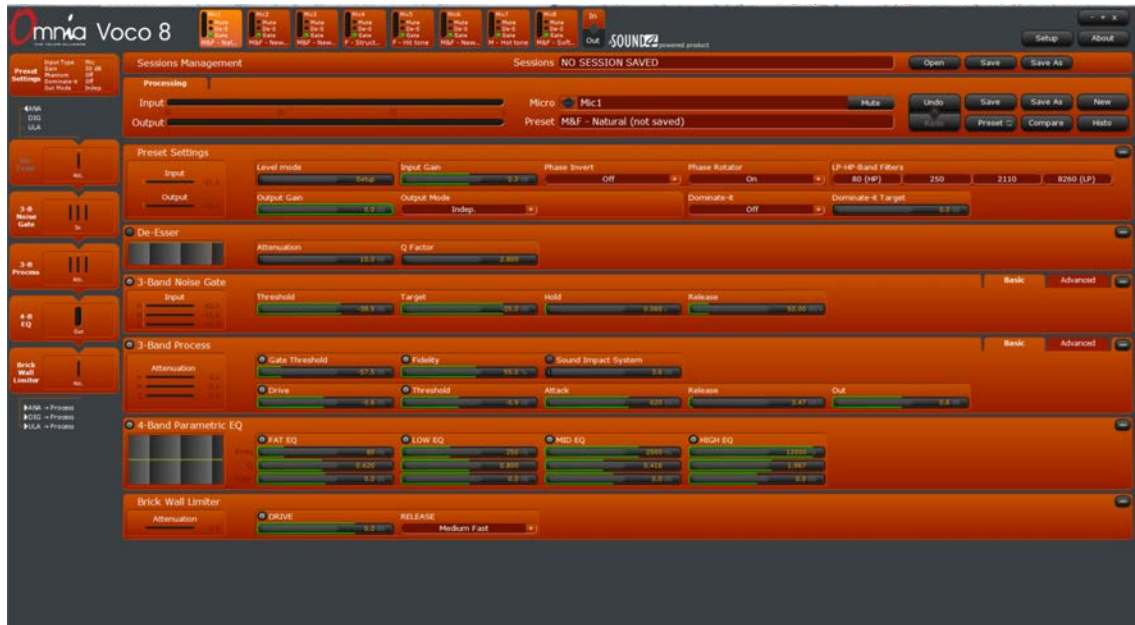

Live

The “Live” account essentially gives a Remote Gateway user access to the same functionality as the front panel (minus the IP configuration options). This account is ideal for granting operators access to basic functions such as loading sessions and presets, without giving them full control over all of the unit’s parameters. Note that metering, gate/de-esser status, and mute controls can be enabled on both the front panel and the Remote Gateway “live” interface.



7

“Live” Account

Overview

The “Live” account provides a simplified user interface designed to emulate the front panel (with the exception of IP configuration and headphone selection) and allows an operator remote access specifically for session and preset selection. This type of account will not allow direct adjustment of processing parameters or system configuration. Multiple “Live” logins can be created and each linked to a specific “Studio” account. These accounts can be assigned to have access only to specific channels if desired.

Interface

In the “Live” interface, only a small handful of controls are available—just enough to allow loading presets and sessions, along with some basic setup parameters.

Window Controls

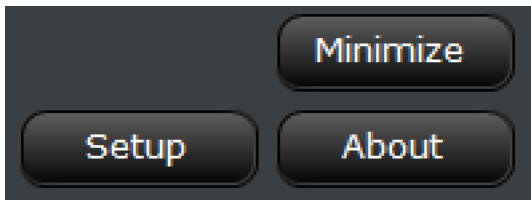

Minimize

Minimizes the program and displays the Windows desktop. Although there is no “Exit” function, Alt-F4 will close the program (as with most Windows programs).

Setup

Enters the setup menu, described later in this chapter.

About

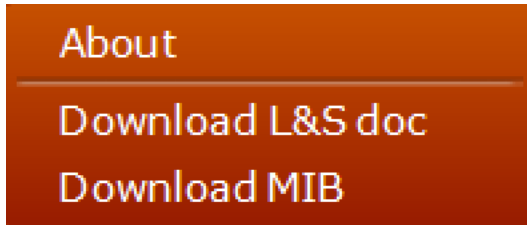

Displays version information about the Remote Gateway program and PC operating system, along with software version, serial number, and MAC addresses from the connected VOCO 8 unit.



Download L&S doc

Retrieves an XML document detailing "Link & Share" parameters. Link & Share allows remote control via TCP of VOCO 8 parameters from an external automation system.

Download MIB

Retrieves the SNMP MIB for VOCO 8 for use with 3rd party network management systems.

Session Management

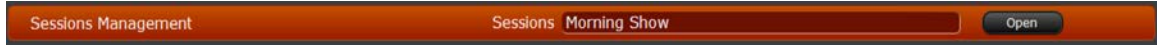

Sessions are used to load (for example) configurations for entire shows, and will select presets on multiple microphone channels simultaneously. This area of the live interface displays the currently loaded session (if any) and allows opening a different session. New sessions cannot be saved from within the “live” interface.



Clicking the “Open” button will bring up a list of sessions available to the current login account and an onscreen keyboard for searching the list. Click the first character of the session you wish to search for to display all sessions beginning with that character.

Note:

This interface will only search for the FIRST character of a session. Clicking a second character will change the search to that character. You may want to name all presets and sessions with an easily identified first character as a “category” indicator.

To clear the search and display all sessions again, click on “All”. If the list contains more entries than can be displayed in the window, click the up and down arrows to scroll through the list. Clicking the desired session in the list will load it immediately. If you want to return to the main screen without loading a session, click “Close”.

Preset Management

To load a preset, click the button on the desired channel labeled with the currently loaded preset for that channel. In the “default” and “minimal” display modes, this is the only available control on each channel. In “full” display mode, it will be under the meters and next to the mute button.



Clicking the preset button will bring up an onscreen keyboard for searching and loading presets. This interface works identically to the one used for loading sessions. Click a preset name to load it immediately, click the up and down arrows to scroll through the list. To search, click on the first character of the preset name you are searching for. To clear the search, click “all”, and to return without loading a new preset, click “Close”.

“Live” Setup Options

Since this is a very “restricted” account, the setup options are limited as well. The only section available in setup for these accounts is “Display”.

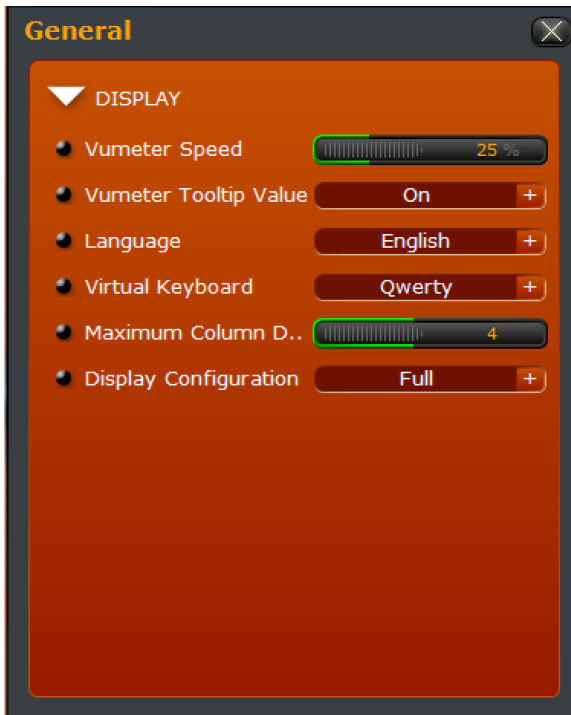

VU Meter Speed

This value controls the speed of the onscreen metering and is expressed in percent. Higher numbers will result in faster metering, though the default of 25% is generally sufficient.

VU Meter Tooltip Value

When “on”, displays the value of VU metering as a “tooltip” as the mouse cursor is hovered over the meter.

Language

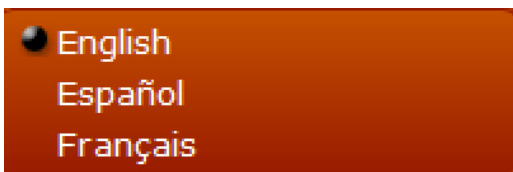

Selects the language of messages and prompts within the user interface. Available options are English, Spanish, and French. Changing this setting will require restarting the software.

Virtual Keyboard



Selects the layout of the on-screen keyboard used when selecting sessions or presets.

Maximum Column Display

Adjusts the overall screen layout and the number of columns that inputs are arranged into, from one to eight. When a single column is selected, VU meters and De-Esser/Gate LEDs (if enabled) may not be displayed. The default is four columns.

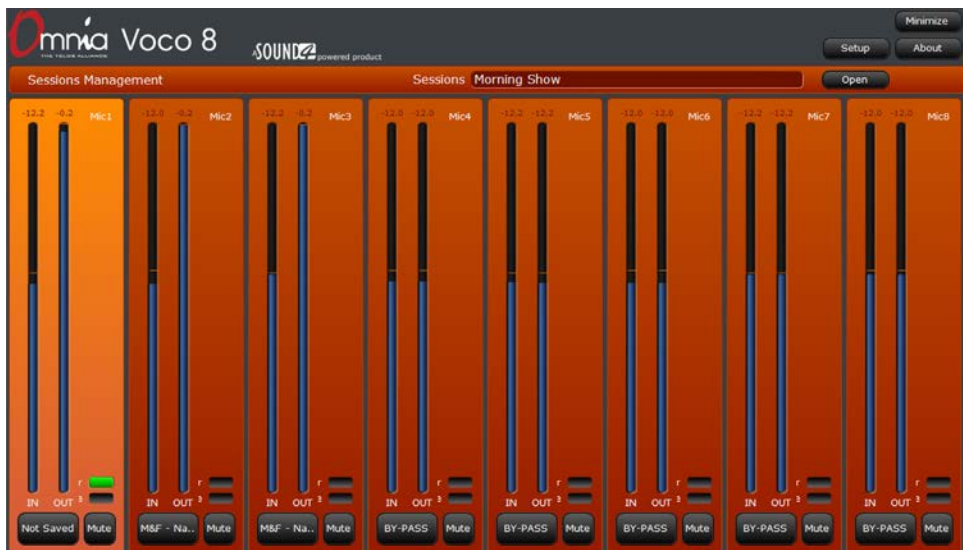
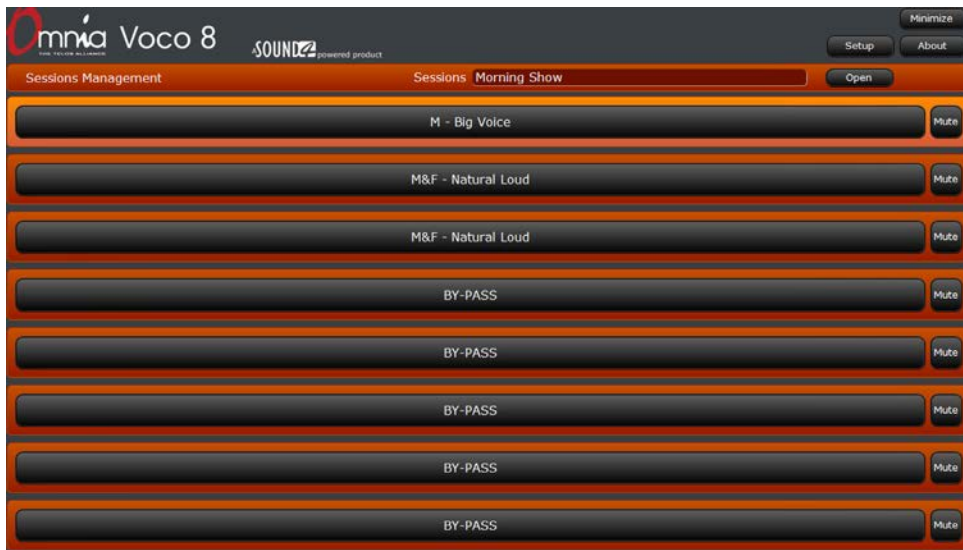

Display Configuration

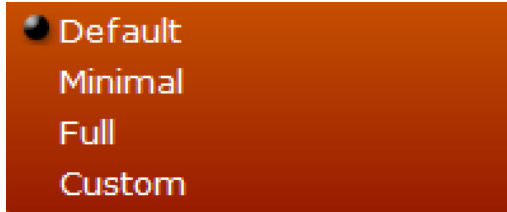

Selects which controls and indicators are displayed for each channel.

Default



Displays preset selection controls and channel names.

Minimal

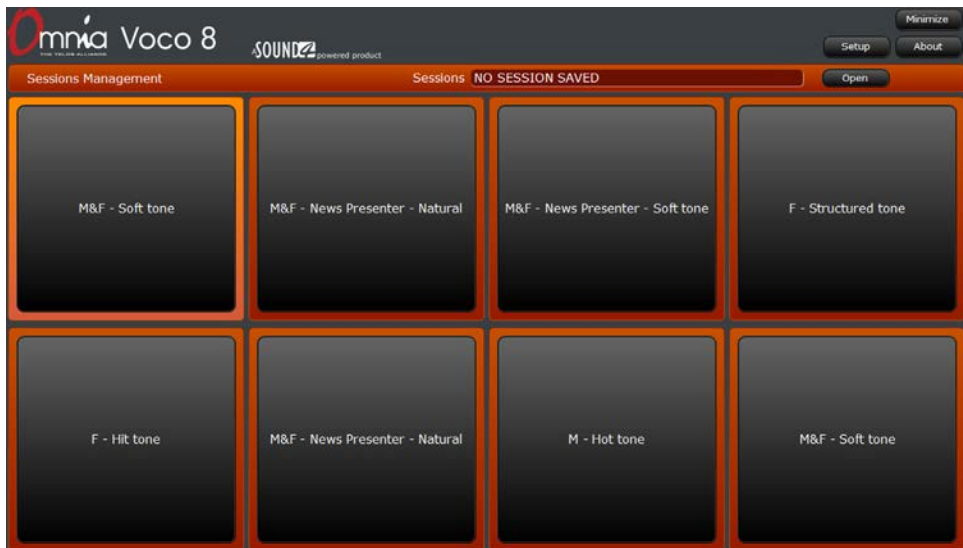

Only displays preset selection controls.

Full

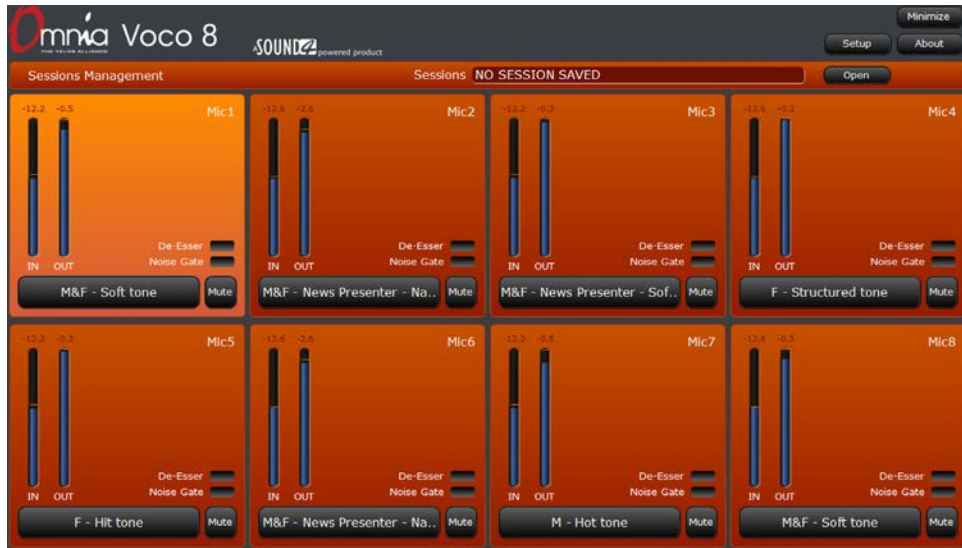

Displays channel names with all available metering and controls, including input and output levels, De-Esser and Noise Gate LEDs, Preset Selection, and Mute.

Custom



When “Custom” is selected, several additional setup options appear which allow hiding or showing each display element individually. In this example, the mute controls are hidden.

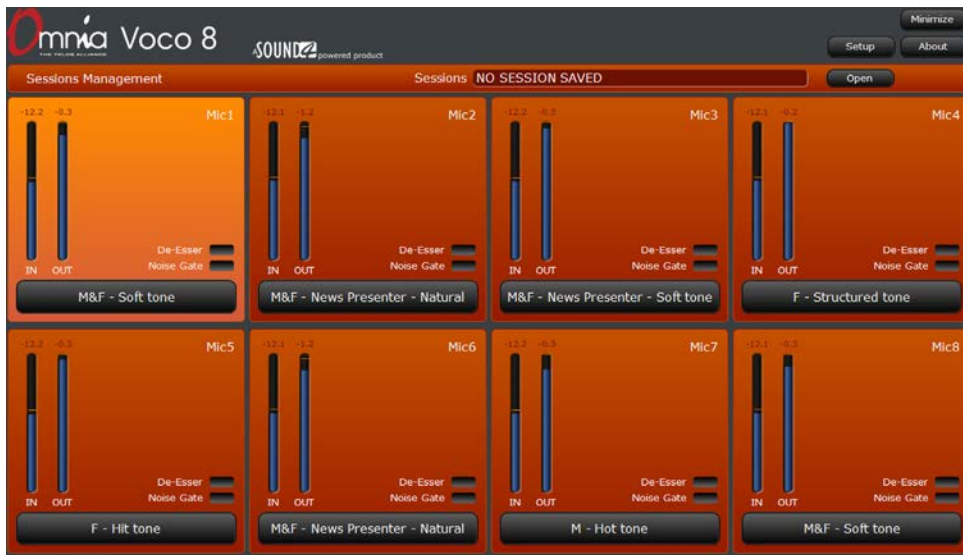

8

“Admin” Account

Overview

Like the “Live” account, the “Admin” account serves a very specific purpose—global system configuration and rights assignment. Unlike the “Live” and “Studio” accounts, there can only be one “Admin” account on the system and it can never be deleted. This account provides basic monitoring of all channel input and output levels as well as an overview of loaded presets, but there is no access to processing parameters. In addition, sessions and presets cannot be saved or recalled from this interface.

Interface

Again, similar to the “Live” account, controls in the “Admin” account are limited. Across the top of the window is an overview of channel status and (like the “Live” account) access to setup, “about”, and window management (minimize, maximize, close). The lower portion of the window provides access to some handy internal documentation describing the features of the admin account.

Channel Status Display



In the “Admin” account, the status of all 8 channels is displayed regardless of any rights assignment in other accounts. This overview includes channel name, level, mute/de-esser/gate status, and currently loaded preset name. Select between viewing input or output levels by clicking on “In” or “Out” on the right hand side of this display.

Window Controls

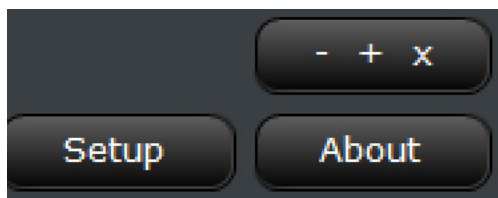

Minimize/Maximize/Restore/Close

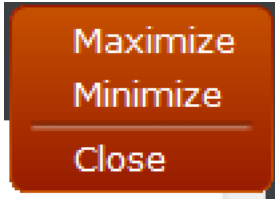

When you click on the - + x button, a menu with window controls is displayed. Behavior follows standard Windows conventions. If the window is already maximized, the option changes to restore. Minimize will display the Windows desktop, and Close will exit the program.

Setup

Enters the setup menu, described later in this chapter.

About

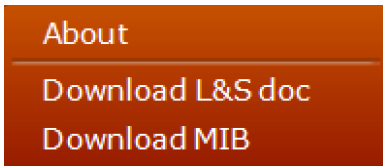

Displays version information about the Remote Gateway program and PC operating system, along with software version, serial number, and MAC addresses from the connected VOCO 8 unit.



Download L&S doc

Retrieves an XML document detailing "Link & Share" parameters. Link & Share allows remote control via TCP of VOCO 8 parameters from an external automation system.

Download MIB

Retrieves the SNMP MIB for VOCO 8 for use with 3rd party network management systems.

“Admin” Setup Options

The “Admin” account has considerably more flexibility in terms of setup options than the “Live” account, but it is still limited primarily to rights assignment and other global configuration parameters.

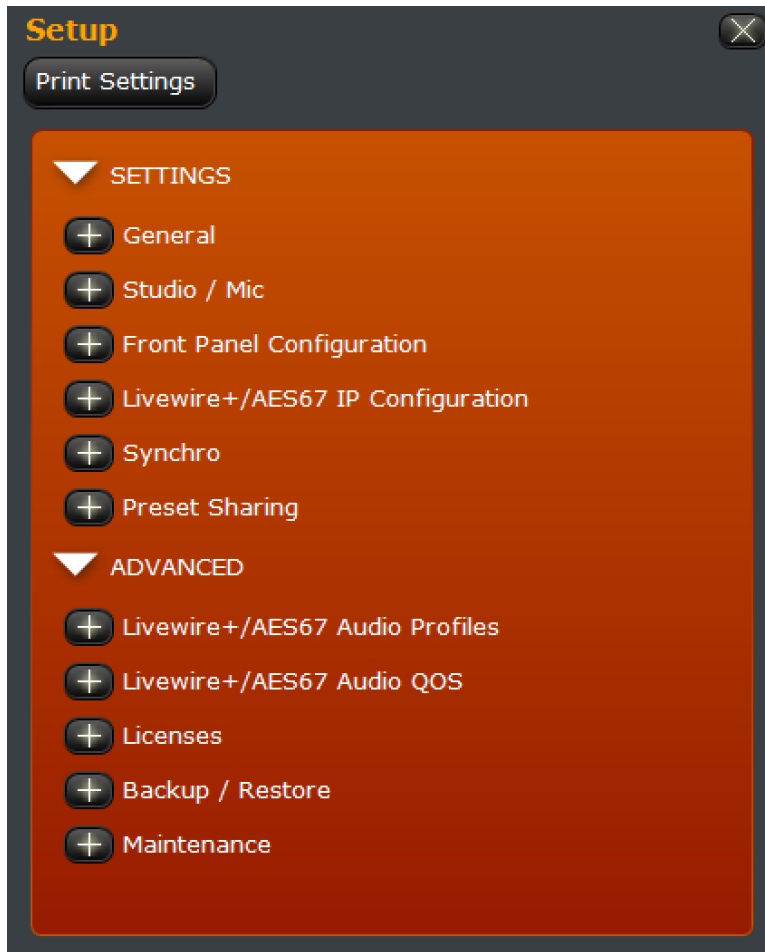

Settings

This section primarily contains “global” configuration settings related to rights assignment, front panel behavior, interface configuration for Audio over IP, digital synchronization, and preset sharing between VOCO units.

General

These settings control the name of the unit on the network, and how the application behaves overall.



Processor Name

Controls the “internal” name of the processor that appears when scanning for units and connecting via Remote Gateway, and the network host name (for the AoIP interface) presented to other devices on the network. Set both of these to give the VOCO a uniquely identifiable name on your network (i.e. Studio-A-VOCO).

Display

Configures various parameters related to the display of controls within the application.

VU Meter Speed

This value controls the speed of the onscreen metering and is expressed in percent. Higher numbers will result in faster metering, though the default of 25% is generally sufficient.

Control Size

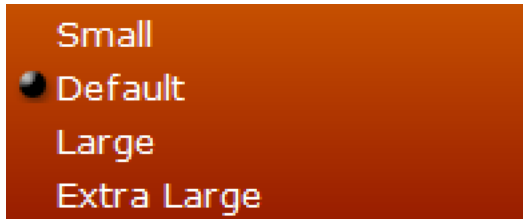

Selects the size of controls within the Remote Gateway application.

VU Meter Tooltip Value

When "on", displays the value of VU metering as a "tooltip" as the mouse cursor is hovered over the meter.

Setup Group View



Selects whether multiple groups within the setup window can be opened simultaneously, or if the currently open group closes as another is opened.

Language

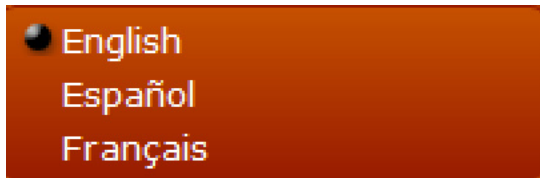

Selects the language of messages and prompts within the user interface. Available options are English, Spanish, and French. Changing this setting will require restarting the software.

Application Auto Exit

Configures the Remote Gateway application to automatically exit after the specified period of time. This can be helpful for maintaining security in an environment where the Remote Gateway application may be on a studio or other shared PC (for example).

My User Data

These fields are primarily for reference. Enter your name and e-mail address to display within the software or to external systems.

Studio/Mic

The “Studio/Mic” window is where login accounts are managed and associated with “Studio” or “Live” privileges. This window also controls linking a “Live” account to a “Studio” account, and assigns microphone inputs to the “Studio” logins.



By default there is a single “Studio” account with all microphone inputs assigned to it. There is also a default “Live” account linked to this “Studio” account. In addition to the “Studio”, “Live”, and “Admin” accounts, there is also a “PresetSharing” account for sharing of presets between VOCO units with the same password set on this account. This account (like the admin account) cannot be deleted.

For many applications these default logins may be sufficient, but we recommend at the very least changing the default admin password and assigning passwords to the other accounts.

Note: The default admin password is “admin”.

If you change the admin password, record it in a safe place. Contact support if you have changed and lost the admin password for your VOCO unit.

Creating New User Accounts

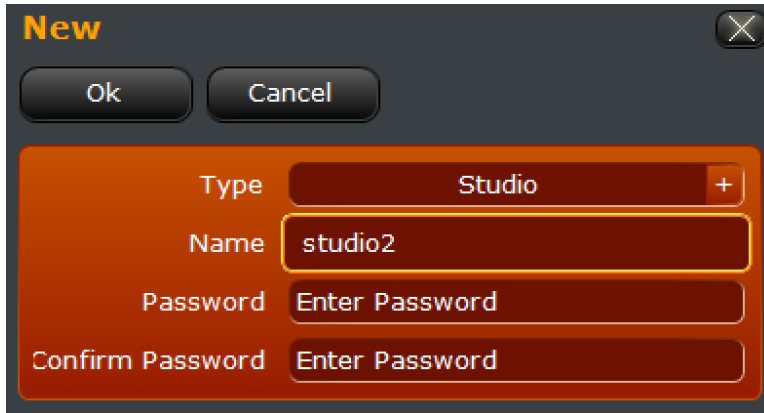

The 'New' dialog box is shown with a dark grey background and orange accents. It features a title bar with the word 'New' in orange and a close button (X) in the top right corner. Below the title bar are two buttons: 'Ok' and 'Cancel'. The main area contains four input fields: 'Type' with a dropdown menu set to 'Studio' and a plus sign; 'Name' with a text box containing 'studio2'; 'Password' with a text box containing 'Enter Password'; and 'Confirm Password' with a text box containing 'Enter Password'.

To create a new login, click on "New" from the "Studio/Mic" window.

There are only two options for "Type". The default is "Studio". You will need to create a "Studio" account PRIOR to creating a "Live" account if you wish to link them. "Live" accounts MUST be linked to an existing "Studio" account.

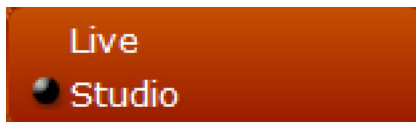

A horizontal bar with an orange-to-brown gradient background. It contains two radio button options: 'Live' (unselected) and 'Studio' (selected, indicated by a black dot).

Enter the name for the new account and (if desired) a password. Click OK to close the window and save changes or cancel to return to the "Studio/Mic" window without creating the new account.



The 'Studio / Mic' window has a dark grey title bar with the text 'Studio / Mic' in orange and a close button (X) in the top right corner. Below the title bar are five buttons: 'New', 'Assign', 'Edit', 'Password', and 'Delete'. The main area is divided into two sections. The top section, titled 'Users List:', contains a table with the following data:

Activate	Name	Type	Password	Assign To
<input checked="" type="checkbox"/>	studio	Studio	none	
<input checked="" type="checkbox"/>	live	Live	none	studio
<input checked="" type="checkbox"/>	admin	User Administrator	ok	
<input checked="" type="checkbox"/>	PresetSharing	Preset Sharing	ok	
<input checked="" type="checkbox"/>	studio2	Studio	none	

The bottom section, titled 'Current User:', contains two input fields: 'Name' with the value 'admin' and 'Type' with the value 'User Administrator'.

Assigning Microphones to Studios

From the "Studio/Mic" window, click on the "Assign" button to manage which microphones are available to which studio accounts. This will control which channels appear both in that "Studio" login and any associated "Live" login. Click OK to save changes or cancel to return to the "Studio/Mic" window without saving changes.

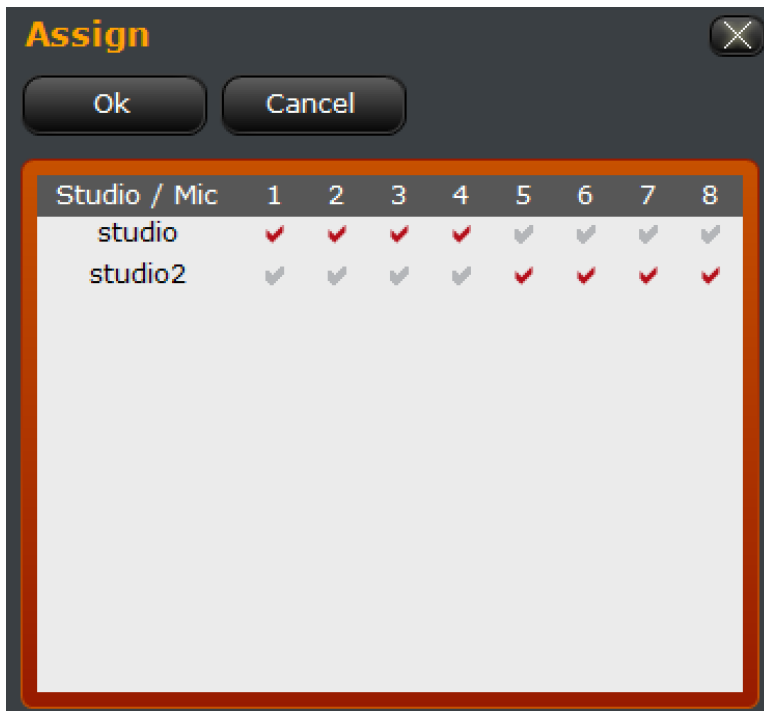

Note:

These assignments are ONLY for access management and do NOT affect physical audio routing within the VOCO. All routing of input and output audio to studios must be done separately and should match the associated logins for controlling those microphone channels.

Creating and assigning a new “Live” account to a studio

From the “Studio/Mic” window, click “New”. Select “Live” as the type. Once “Live” is selected as the type, the “Assign” menu will appear.

The 'New' dialog box contains the following fields:

- Type: Live
- Assign: studio2
- Name: studio2 live
- Password: Enter Password
- Confirm Password: Enter Password

All “Live” accounts must be assigned to a specific “Studio” account to determine which channels they should control. Select the desired “Studio” account from the “Assign” menu.

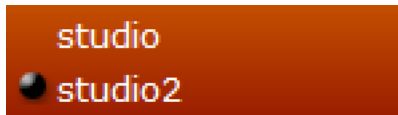

Enter a new name and password (if desired) for this login. Click OK to save and return to the “Studio/Mic” window, or cancel to return without saving.

The 'Studio / Mic' window displays a 'Users List' table with the following data:

Activate	Name	Type	Password	Assign To
<input checked="" type="checkbox"/>	studio	Studio	none	
<input checked="" type="checkbox"/>	studio2	Studio	none	
<input checked="" type="checkbox"/>	studio2 live	Live	none	studio2
<input checked="" type="checkbox"/>	live	Live	none	studio
<input checked="" type="checkbox"/>	admin	User Administrator	ok	
<input checked="" type="checkbox"/>	PresetSharing	Preset Sharing	ok	

Current User:

Name: admin
Type: User Administrator

The newly created account should appear in the list along with the corresponding studio assignment.

Other Options

From the "Studio/Mic" window, there are several other account management options available.

Edit

Edits the parameters of the selected account.

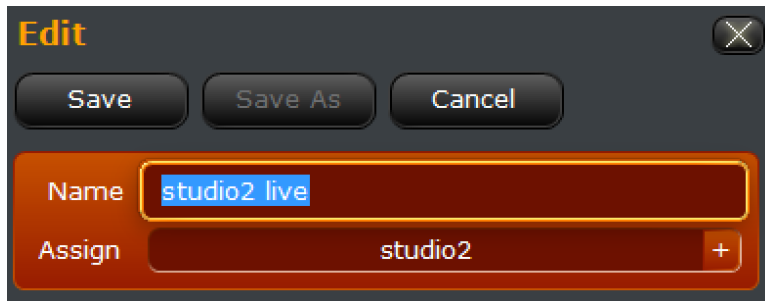

Password

Changes the password of an account or assigns a new one. To clear the password on an account, enter the existing password in "Old Password" and leave both "New Password" and "Confirm Password" blank. If you do not have the existing password for an account it will not be possible to clear or change it.

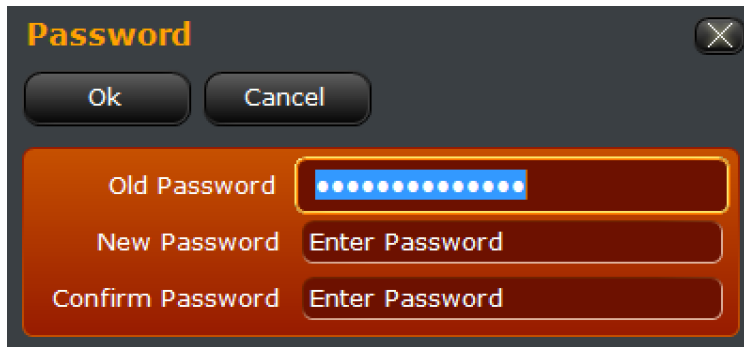

Delete

While it is not possible to change the password for an account without the old password, it is possible to delete and re-create them. The admin and presetsharing accounts cannot be deleted.

Front Panel Configuration

This section deals with behavior of the VOCO 8 front panel, including the ability to set passwords, along with which channels and controls are available.

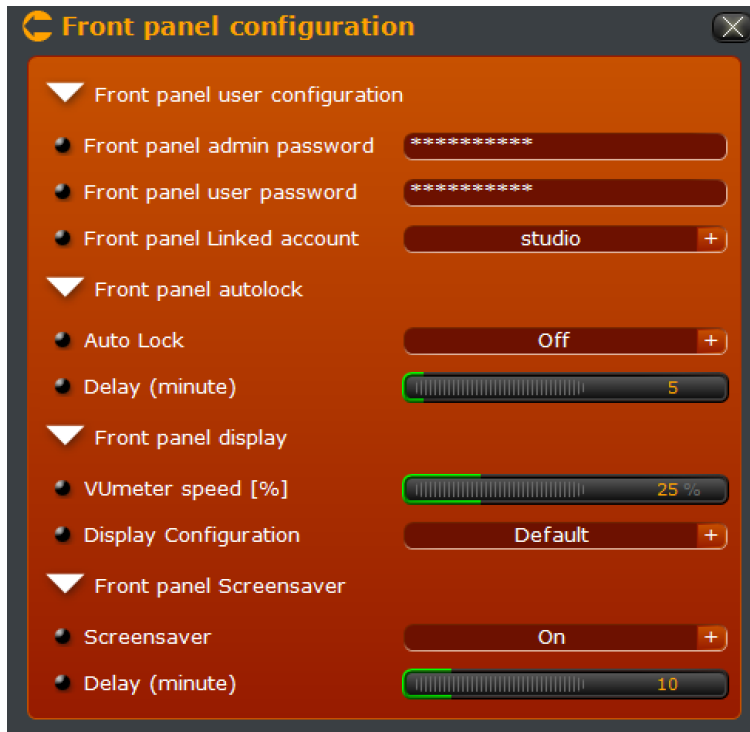

Front Panel User Configuration

Configures a front panel password (if desired) and links the front panel to a “Studio” account (similar to the way “Live” accounts are linked to “Studio” accounts).

Front Panel Admin Password

Allows front panel access to user controls and administrative functions such as setting IP addresses. The default password is admin. A front panel password would be requested if “Front Panel Auto Lock” is on. The front panel admin password is also requested when applying a software update from the front panel via USB. The currently set password (if any) can be removed by clearing this field.

Front Panel User Password

Allows front panel access only to user controls such as preset and session selection, and headphone output. There is no default password. A front panel password would be requested if “Front Panel Auto Lock” is on. The currently set password (if any) can be removed by clearing this field.

Front Panel Linked Account

Selects which “Studio” account the front panel controls are linked to. The channels displayed on the front panel will follow the microphone channels assigned to that particular “Studio” account.

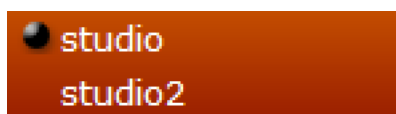

Front Panel Auto Lock

Controls whether or not the front panel is automatically locked after the specified period of time. If Auto Lock is "Off" the value for Delay is ignored and the front panel will not automatically lock.

Front Panel Display

Controls the behavior and layout of the front panel indicators and controls.

VU Meter Speed (%)

This value controls the speed of the onscreen metering and is expressed in percent. Higher numbers will result in faster metering, though the default of 25% is generally sufficient.

Display Configuration

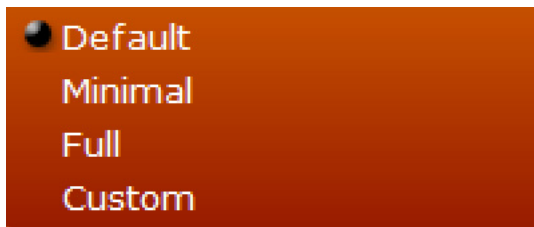

Selects which controls and indicators are displayed for each channel.

Default



Displays preset selection controls and channel names.

Minimal



Only displays preset selection controls without channel names.

Full



Displays channel names with all available metering and controls, including input and output levels, De-Esser and Noise Gate LEDs, Preset Selection, and Mute.

Custom

When “Custom” is selected, several additional setup options appear which allow hiding or showing each display element individually. In this example, the mute controls are hidden.



Front Panel Screensaver

Enables or disables the VOCO 8 screen saver on the front panel LCD and sets the delay before activation.

Livewire+/AES67 IP Configuration

Similar to the front panel interface, the Livewire+/AES67 IP Configuration screen allows you to set and verify IP configuration parameters for the Audio over IP interface. The first section allows you to SET the parameters while the second section allows you to review and verify the current settings. Consult your network administrator if you are unsure of any of these settings.

The screenshot shows a configuration window titled "Livewire+ / AES67 IP Configuration". It is divided into two main sections: "BASIC" and "CURRENT (DISPLAY ONLY)".

BASIC

Network host name	VOCO
DHCP	On +
IP Address	192.168.200.228
IP Default Gateway	192.168.100.254
IP Mask	255.255.255.0
IP Broadcast	
DNS Server	
DNS Server 2	

CURRENT (DISPLAY ONLY)

IP Status	DHCP
MAC address	XXXXXXXXXX
Network host name	VOCO
IP Address	192.168.200.208
IP Subnet Mask	255.255.255.0
IP Gateway	192.168.200.254
IP Broadcast	192.168.200.255
DNS Server	192.168.200.254
DNS Server 2	Unknown

Caution:

Use extreme care when configuring AoIP interface settings and connecting to a network. An incorrectly configured AoIP device connected to an otherwise properly functioning network can cause network traffic disruption or other serious issues.

Basic*Network host name*

Enter the desired network host name for the VOCO 8 AoIP interface. This should be something that uniquely identifies this VOCO unit on the network (i.e. StudioA-VOCO-AoIP).

DHCP

Selects whether or not DHCP is enabled on the AoIP interface. While it is possible to use DHCP, it is recommended that you assign a static IP address to the unit either by reserving an address for the interface MAC address in the DHCP server, or by disabling DHCP and entering static IP address parameters manually.

Note:

The following options will be greyed out if DHCP is enabled.

IP Address

Enter the IP address you wish to assign to the AoIP interface.

IP Default Gateway

Enter the default gateway for this network (if applicable).

IP Mask

Enter the subnet mask for this network (255.255.255.0, for example, in the case of a typical "Class C" or /24 network).

IP Broadcast

The "Broadcast" address for the network. This address is used for network discovery and management purposes. This address will be determined automatically based on the subnet mask. For example if the IP address is 192.168.1.10 with a subnet mask of 255.255.255.0, the broadcast address will be 192.168.1.255.

DNS Server

Enter the IP address of the network's DNS (domain name system) server. This allows systems on the network to be accessed by name, rather than IP address. If your AoIP network does not use a DNS server, this field is not required.

DNS Server 2

Enter a second DNS server if your network uses one.

Current (Display Only)

Displays currently configured AoIP interface parameters as well as error messages if the interface is not configured properly. It should reflect the parameters manually entered above, or those assigned by DHCP.

Synchro

Configures and displays the status of AoIP synchronization parameters. Livewire+ and AES67 are both supported as sync sources for the VOCO 8, and the VOCO 8 may serve as either a master or slave for clock on these networks. Synchronization to an internal clock source is also available.

The screenshot shows a configuration window titled "Synchro" with a dark orange background. It is organized into several sections:

- GENERAL**: Reference Clock is set to "Internal".
- LIVEWIRE+ SYNCHRO**: Livewire+ clock master is set to "1". Std clk ip, Live clk ip, Std clk port, and Live clk port are all set to "Default".
- AES67 SYNCHRO**: Always Slave is set to "No". Domain is set to "0 - Default". Priority 1 and Priority 2 are both set to "128". Sync Delay [s] is set to "1.000".
- SYNCHRONISATION**: Sync Src Mode is set to "Internal". Livewire Sync State is set to "Asynch". Livewire Sync IP is set to "192.168.200.204". AES67 Sync State is set to "Master".



Selects whether the VOCO 8 will be synchronized to the high precision internal clock, Livewire, or AES67. Set this to “Internal” if you are not using AoIP, or if the VOCO 8 will be the master (grandmaster) clock source on the AoIP network.

Livewire+ Synchro

Configuration settings specific to Livewire+ clock synchronization—Download the Axia “Introduction to Livewire+” primer from <http://telosalliance.com/lwintro> for more detailed information on Livewire+ and these settings.

Livewire+ clock master

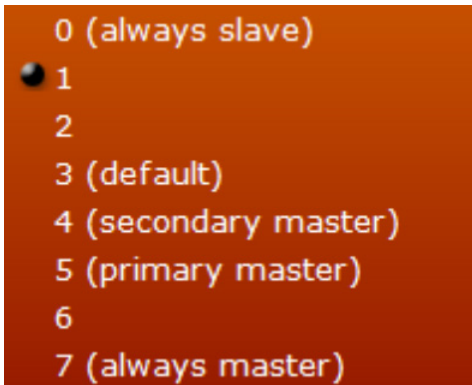

Selects what priority the clock in the VOCO 8 has relative to other devices on the Livewire+ network. The Livewire+ clock is distributed among all of the devices on the network and any Livewire+ device can function as a master if the existing master clock source on the network should become unavailable for some reason. Higher priorities are more likely to become a master clock source on the network and lower priorities are less likely to become a master. Devices can also be forced to either “Always Slave” (Priority 0) or “Always Master” (Priority 7) though it is recommended to leave this setting at the default value unless there is a specific network design topology with a designated primary and secondary master. Most Axia devices have “3” as the default priority. The VOCO 8 is set to “1” by default so it will generally not try to become a master on an existing Livewire+ network unless configured to do so.

Note:

Both Livewire “Standard” and “Live” (low latency) streams are supported by VOCO 8.

Standard Clock IP

Configures the IP address of the clock source for “Standard” streams. This is determined automatically by default and generally should not be changed.

Live Clock IP

Configures the IP address of the clock source for “Live” streams. This is determined automatically by default and generally should not be changed.

Standard Clock Port

Configures the IP port of a clock source for “Standard” streams. This is determined automatically by default and generally should not be changed.

Live Clock Port

Configures the IP port of a clock source for “Live” streams. This is determined automatically by default and generally should not be changed.

AES67 Synchro

Configures the settings for PTP/IEEE 1588-2008 synchronization on a AES67 AoIP network.

Always Slave

Determines whether or not the VOCO 8 can function as a PTP/IEEE 1588 master if the existing master clock source on the AES67 network should become unavailable for some reason. When set to “Yes” the VOCO 8 will only attempt to function as a slave on these networks.

Domain

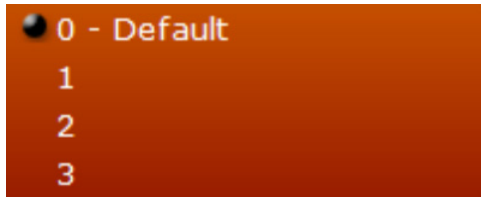

Selects the PTP/IEEE 1588 clock domain used on the AES67 network. This would be used if a network has multiple PTP/IEEE 1588 clock references running simultaneously for different purposes but typically does not need to be changed on a dedicated AoIP network.

Priority 1

Sets Priority 1 for the VOCO 8 clock in the PTP/IEEE 1588 domain relative to other devices on the network. A lower value equals a higher (preferred) priority. Used in conjunction with “Priority 2”.

Priority 2

Sets Priority 2 for the VOCO 8 clock in the PTP/IEEE 1588 domain. A lower value equals a higher (preferred) priority. In IEEE 1588-2008, this value is used when choosing a grand master if the other criteria are equal (Priority 1, Class, Accuracy, Variance). If this value is also equal, the lowest MAC address of the potential PTP/IEEE 1588 grand masters is used as a tiebreaker.

Sync Delay

Sets the period of PTP/IEEE 1588 synchronization packets when VOCO 8 is the clock master. The default of 1 second is generally sufficient. A lower value (0.1s) may achieve faster synchronization of slave devices on the network.

Synchronization

Read only display of current sync status

Sync Source Mode

Displays the current source for sync (Internal, Livewire+, or AES67)

Livewire+ Sync State

Displays the current status of Livewire+ sync (Master, Slave, or Asynch). Asynch means a Livewire+ clock is detected but not used because of the current configuration.

Livewire+ Sync IP

Displays the IP address of the current Livewire+ sync source if operating as "Slave" or "Asynch". If operating as master, this field does not appear.

AES67 Sync State

Displays the current status of AES67 (PTP/IEEE 1588) sync (Master, Slave, or Asynch). Asynch means a PTP/IEEE 1588 clock is detected but not used because of the current configuration.

AES67 Sync IP

Displays the IP address of the current AES67 (PTP/IEEE 1588) sync source if operating as "Slave" or "Asynch". If operating as master, this field does not appear.

Note:

A status of "Asynch" may indicate synchronization issues on the network and result in audio glitches. Double-check the synchronization and clock settings on the VOCO 8 and other devices on your AoIP network. Ensure that the "Reference Clock" field is set properly on the VOCO 8.

Preset Sharing

One of the more unique features of the VOCO 8 is the ability to automatically share presets across the network without the need to manually copy and save them to every single VOCO in your facility. Presets modified in one studio can instantly be updated in all other studios to reflect those modifications. This saves a considerable amount of time and ensures your carefully tuned sound stays consistent no matter which studio is in use. Presets can even be shared with remotely located VOCO 8 units in other facilities assuming there is IP connectivity between the two facilities.

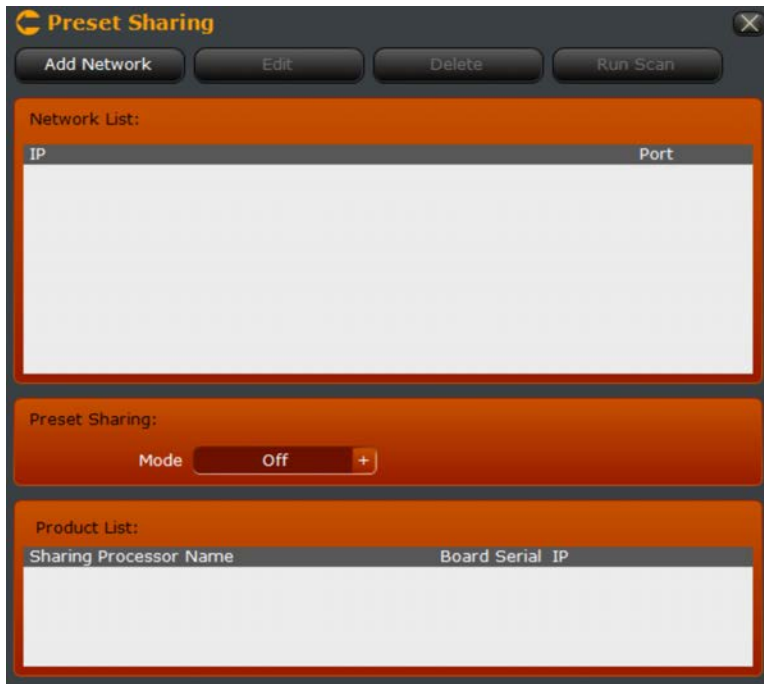

First, change the Preset Sharing mode from “Off” to “On”.

Note:

Ensure that the password for the “PresetSharing” account on all VOCO 8 units that will share presets is set identically.

Adding networked VOCO units to preset sharing

To add one or more VOCO units to the list, click on “Add Network”.

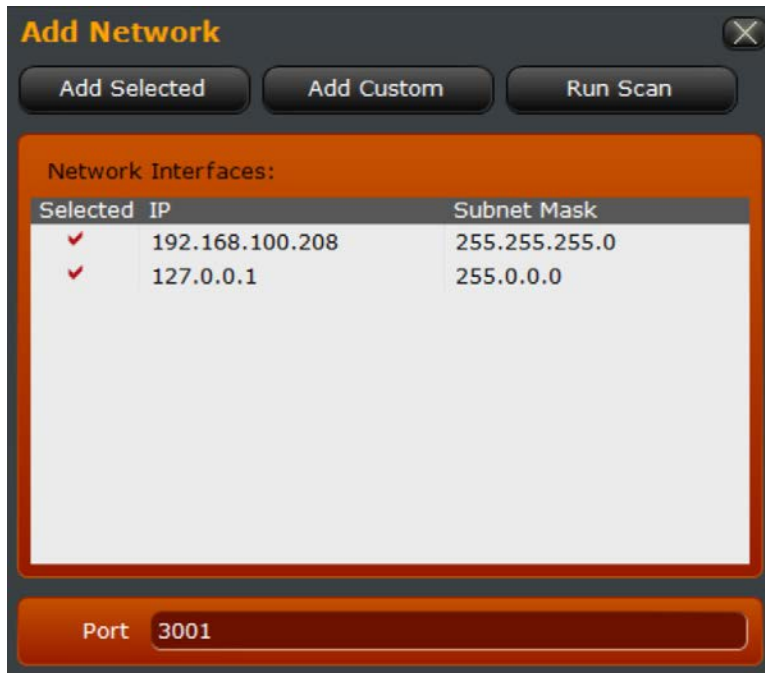

A list of interfaces and networks on the connected VOCO will be displayed. Click “Add Selected” to add the detected networks to the preset sharing list. “Run Scan” will rescan for interfaces.

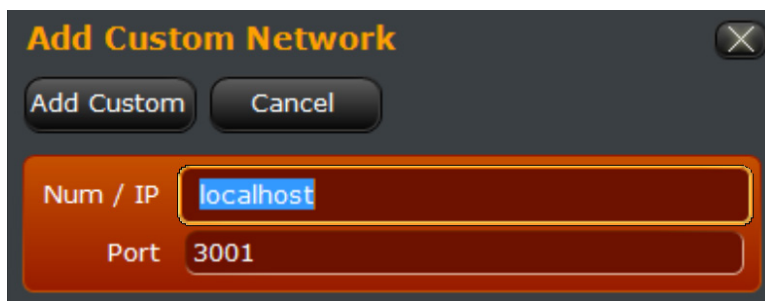

If the interface is not displayed for some reason, click “Add Custom” to add a custom IP address. This function can also be used to add remotely located VOCO 8 units that may not be detected through a local network scan. The default port for preset sharing is 3001 and should not be changed unless necessary.



Double-check to ensure that "Preset Sharing" is turned "On". Click "Run Scan" to find additional VOCO units on the network. Click "Edit" to edit an interface entry in the list, or "Delete" to delete an entry.

Advanced

These settings control advanced configuration parameters related to AoIP formats and QoS, unit licensing, backup and restore of unit configurations, and maintenance functions such as rebooting components of the system. A logging function for specific AoIP traffic is provided as well.

Livewire+/AES67 Audio Profiles

Controls packet length and sample format parameters for several configurations of AES67 AoIP traffic. The profiles supported are "Standard", "Low Delay", and "Very Low Delay". The available parameters for each of the three profiles are identical, though the default values are different.



Sample Format

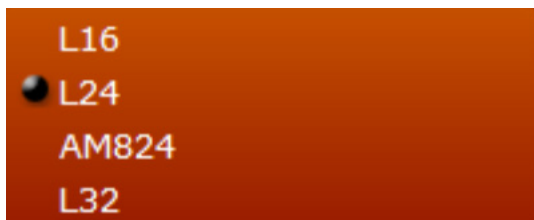

Supported formats for AES67 profiles are 16 bit, 24 bit, and 32 bit linear. AM824 is a 32 bit format with 24 bits of audio data and 8 bits for AES3 side-band data. The format was proposed but never fully standardized. It is included here for experimental purposes only.

Packet Length



Adjusts the AoIP packet length in samples. A shorter length results in lower latency with higher bandwidth overhead. Longer lengths have more latency but a lower bandwidth overhead.

Livewire+/AES67 Audio QoS

Adjusts the 802.1p Quality of Service (QoS) parameters of various AoIP formats, also configures 802.1Q VLAN tagging for AoIP. Separate QoS settings are provided for each supported type of AoIP stream (including PTP/IEEE 1588 clocking).

Note:

Do not change these settings unless you have a specific application that requires them to be modified. The defaults are generally sufficient for most installations. Improper configuration of these parameters can cause audio glitches and other network issues. A full description of these QoS functions is beyond the scope of this manual.



Livewire+ Default QoS Settings



AES67 Default QoS Settings



PTP/IEEE 1588 Clock Default QoS Settings

Receive Buffer Size [ms] (audio streams only)

Adjusts the packet receive buffer size (in milliseconds) for AoIP streams. Increasing this number will increase audio latency. Reducing these values too much may result in audio glitches. The default values should be sufficient and will add to the overall latency of each stream type. Note that this is only available for audio streams, and not PTP/IEEE 1588 clock packets since clock packets must be processed without additional buffering.

802.1 Tagging

Controls whether or not packets are tagged with 802.1Q information (including a VLAN ID and priority). Use this in combination with appropriate switch configurations to route specific types of AoIP packets to specific VLANs with specific priorities (802.1p).

802.1 VLAN ID

Specifies the 802.1Q VLAN ID to be used when 802.1 tagging is enabled.

802.1 Priority

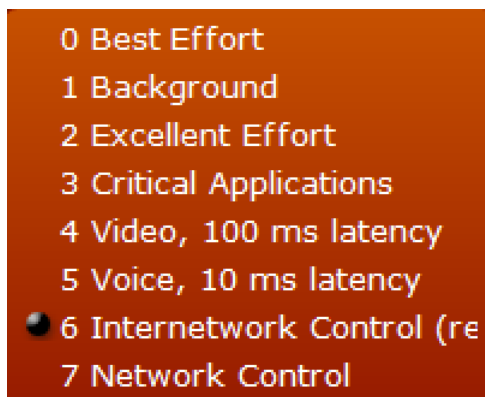

Specifies the 802.1p priority level in the 802.1Q tagged packet.

DSCP Class of Service

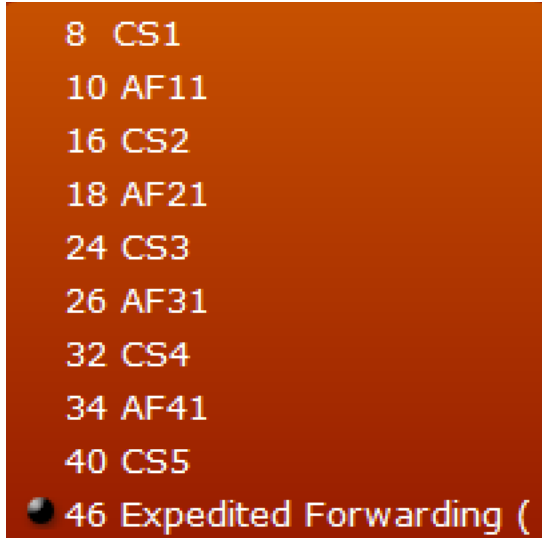

Specifies the Differentiated Services (DiffServ) Code Point (DSCP) for traffic management classification on networks that support DiffServ.

Licenses

License keys enable additional processing channels and other features on the VOCO 8. The “base” VOCO 8 is licensed for 2 channels of processing and supports up to 8. All licenses for features purchased with the unit should have already been loaded at the factory.

The “Licenses” section of setup allows new license keys to be loaded on the system in the field if any additional features are purchased at a later date. This screen also displays the serial number and MAC addresses of the VOCO, which will be required for the new license keys to be generated.

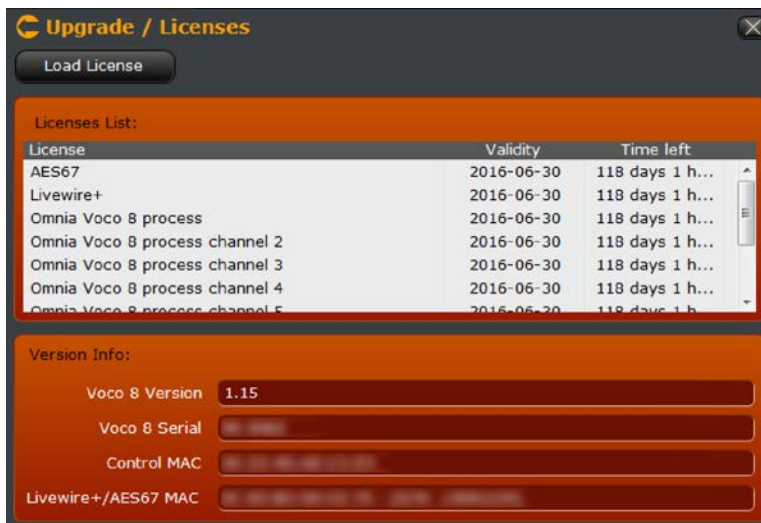

To load a new license, click “Load License” and locate the file. The license key is delivered as a ZIP file. Do NOT unzip this file. It will be loaded directly into the system. Once the license file has been loaded, the added licenses and features should appear in this window. If the expected features do not appear or if there is any issue loading the license file, contact technical support.

Backup/Restore

Allows the VOCO 8 configuration to be backed up to or restored from a file. Note that this also includes passwords. If a VOCO 8 configuration containing passwords is restored to another VOCO 8, those passwords (including admin) will be restored as well. It is important to know the passwords (if any) stored in a backup file before restoring it to another unit.

Note:

If a backup containing an unknown admin password is restored to the unit, it will become impossible to access that unit. Contact technical support for further assistance.

The “Control” IP configuration will not be modified when restoring a backup. This allows you to restore a backup remotely without losing connectivity to the unit.



The “Backup/Restore” page also allows you to restore the unit to factory defaults. This will clear any user presets and configuration changes (including any new accounts created or passwords changed) .

Unlike restoring from a file, a factory restore WILL clear the existing IP configuration. You will lose connectivity via Remote Gateway and will need to reconfigure these settings from the front panel.

Maintenance

Contains various functions to reset the VOCO 8 hardware and view diagnostic information.

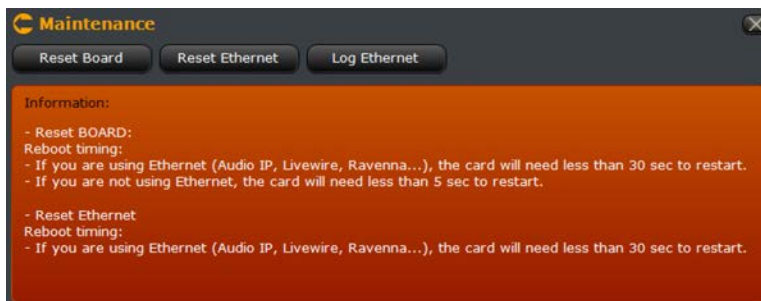

Reset Board/Reset Ethernet

Intended to reset various components of the VOCO 8 system without a complete power off reboot. Contact technical support for further information on these features.

Log Ethernet

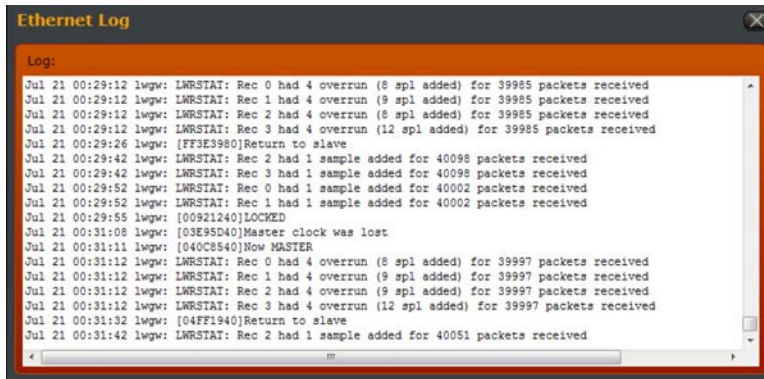

Displays various diagnostic messages from the VOCO 8 Ethernet interfaces.

9

“Studio” Account

Overview

The “Studio” account is where the majority of actual processing configuration and operation takes place. This account allows full access to all session management, preset management, and processing controls. It also contains the setup functions for inputs (including control of phantom power, gain, and pad) and outputs. There can be multiple “Studio” accounts on a system, each with a different set of inputs assigned to it.

Interface

The upper portion of the window (like the Admin account) contains an overview of channel status. Directly to the right of the channel status display (again, like the Admin account) is access to setup, “about”, and window management (minimize, maximize, close). The left hand portion of the window displays an overview of the processing structure, while the rest of the window contains the controls for session and preset management, as well as the actual processing adjustments.

Channel Status Display



In the “Studio” account, only channels assigned to the current studio login are displayed. The overview includes channel name, level, mute/de-esser/gate status, and currently loaded preset name. Click on a channel to select it for adjustment. If the same preset is loaded on multiple channels, they will be selected simultaneously. Select between viewing input or output levels by clicking on “In” or “Out” on the right hand side of this display.

Window Controls

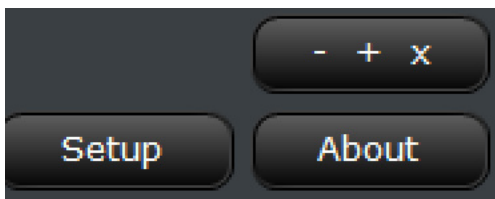

Minimize/Maximize/Restore/Close

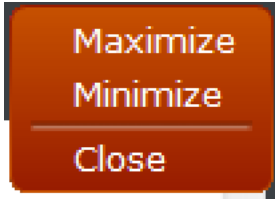

When you click on the - + x button, a menu with window controls is displayed. Behavior follows standard Windows conventions. If the window is already maximized, the option changes to restore. Minimize will display the Windows desktop, and Close will exit the program.

Setup

Enters the setup menu, described later in this chapter.

About

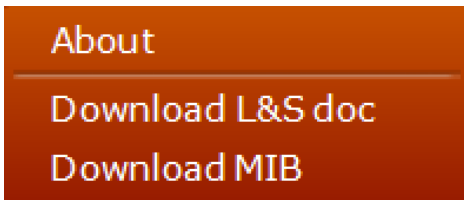

Displays version information about the Remote Gateway program and PC operating system, along with software version, serial number, and MAC addresses from the connected VOCO 8 unit.



Download L&S doc

Retrieves an XML document detailing “Link & Share” parameters. Link & Share allows remote control via TCP of VOCO 8 parameters from an external automation system.

Download MIB

Retrieves the SNMP MIB for VOCO 8 for use with 3rd party network management systems.

“Studio” Setup Options

Setup options in the “Studio” account primarily deal with configuring inputs and outputs. There are several settings that are similar to those in the “Admin” account but can only be viewed and not changed from the “Studio” account.

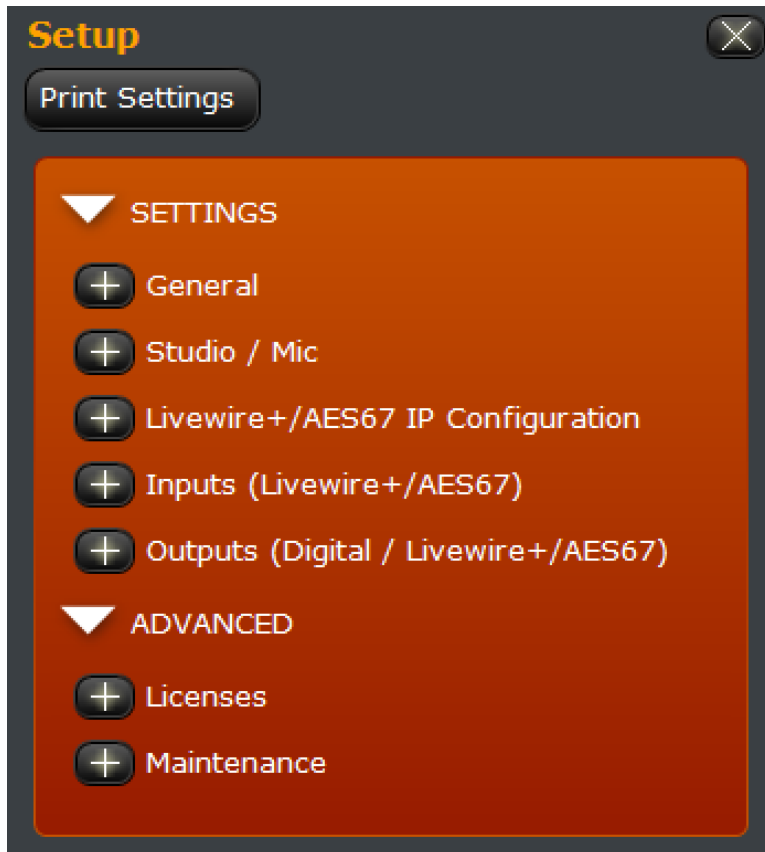

Settings

This section contains settings related to the behavior of the Remote Gateway software, values for the current account’s “Studio” to “Live” assignments, an overview of AoIP interface configuration, and all settings for inputs and outputs.

General

These settings control how the application behaves overall and display the name of the unit on the network.



Processor Name

Displays the “internal” name of the processor that appears when scanning for units and connecting via Remote Gateway, and the network host name of the “AES67” interface. These can be changed through the “Admin” account.

Display

Configures various parameters related to the display of controls within the application.

VU Meter Speed

This value controls the speed of the onscreen metering and is expressed in percent. Higher numbers will result in faster metering, though the default of 25% is generally sufficient.

Control Size

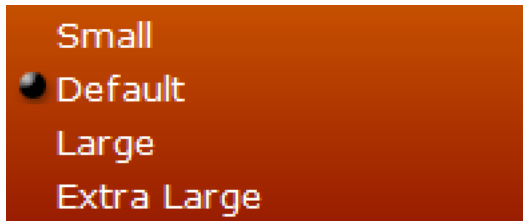

Selects the size of controls within the Remote Gateway application.

VU Meter Tooltip Value

When “on”, displays the value of VU metering as a “tooltip” as the mouse cursor is hovered over the meter.

Setup Group View



Selects whether multiple groups within the setup window can be opened simultaneously, or if the currently open group closes as another is opened.

Language

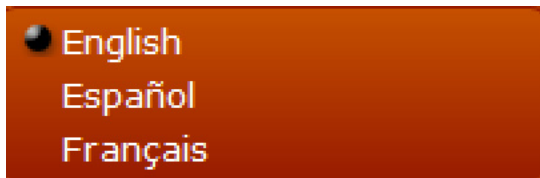

Selects the language of messages and prompts within the user interface. Available options are English, Spanish, and French. Changing this setting will require restarting the software.

Virtual Keyboard



Selects the layout of the on-screen keyboard used when selecting sessions or presets.

Application Auto Exit

Configures the Remote Gateway application to automatically exit after the specified period of time. This can be helpful for maintaining security in an environment where the Remote Gateway application may be on a studio or other shared PC (for example).

Preset Security

Enables or disables automatic re-locking of preset security after the specified period of time when security is enabled on a loaded preset. Preset security prevents viewing or changing any parameters within a preset without entering the preset password.

Process Autolock

Enables or disables automatic lock of all processing controls after the specified period of time. Controls and metering can be viewed when locked but not adjusted.

My User Data

These fields are primarily for reference. Enter your name and e-mail address to display within the software or to external systems.

Studio/Mic

Allows you to manage the password of the currently logged in “Studio” account or associated “Live” account.



To change or clear the password for an account, click on it in the list, then click on “Password”.

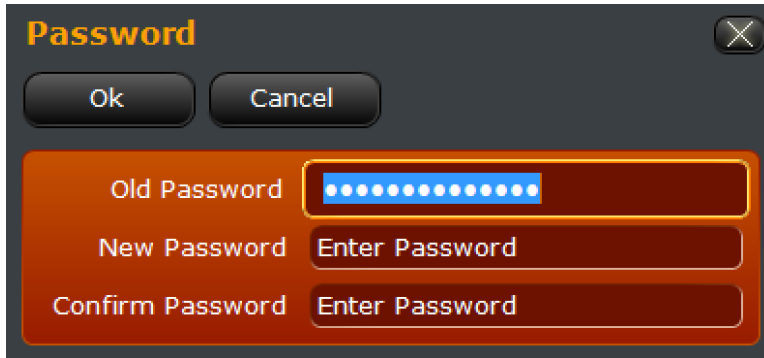

The image shows a dialog box titled "Password" with a close button in the top right corner. Below the title are two buttons: "Ok" and "Cancel". The main area contains three input fields: "Old Password" with a masked password of 10 dots, "New Password" with the placeholder text "Enter Password", and "Confirm Password" with the placeholder text "Enter Password".

To clear a password, enter the existing password in “Old Password” and leave both “New Password” and “Confirm Password” blank. If you do not have the existing password for an account it will not be possible to clear or change it other than through the “Admin” account.

Livewire+/AES67 IP Configuration

Displays the IP configuration for the Livewire+/AES67 interface. In the “Studio” account, this information cannot be changed. It can be only changed through the “Admin” account or from the front panel.

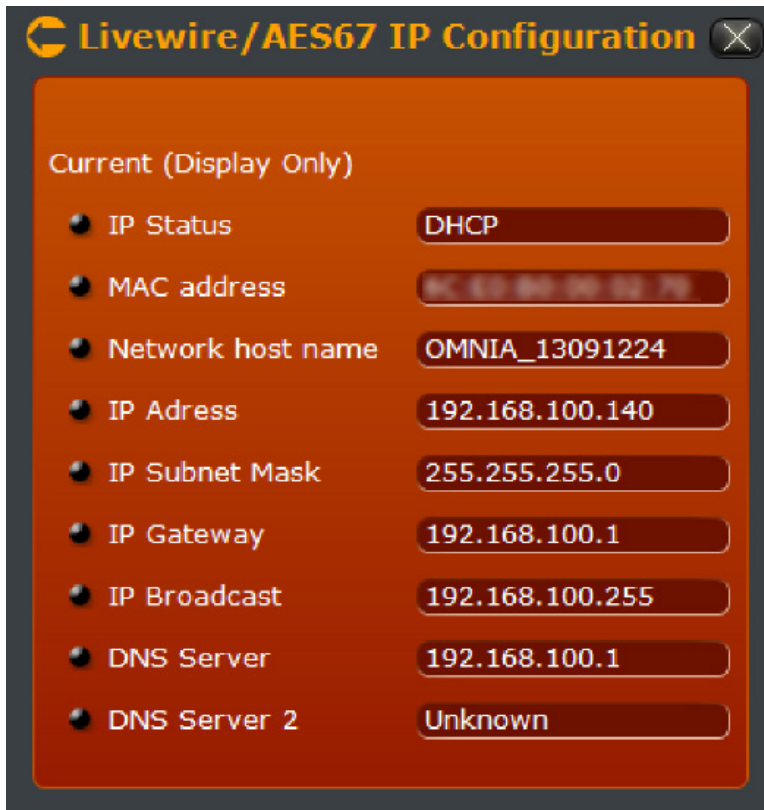

The image shows a dialog box titled "Livewire/AES67 IP Configuration" with a close button in the top right corner. Below the title is a section labeled "Current (Display Only)". This section contains a list of network configuration parameters, each with a radio button and a corresponding value in a text field:

Parameter	Value
IP Status	DHCP
MAC address	XXXXXXXXXX
Network host name	OMNIA_13091224
IP Adress	192.168.100.140
IP Subnet Mask	255.255.255.0
IP Gateway	192.168.100.1
IP Broadcast	192.168.100.255
DNS Server	192.168.100.1
DNS Server 2	Unknown

Inputs (Livewire+/AES67)

Configures the Livewire+/AES67 AoIP input channels including channel naming, input mode, and channel selection.

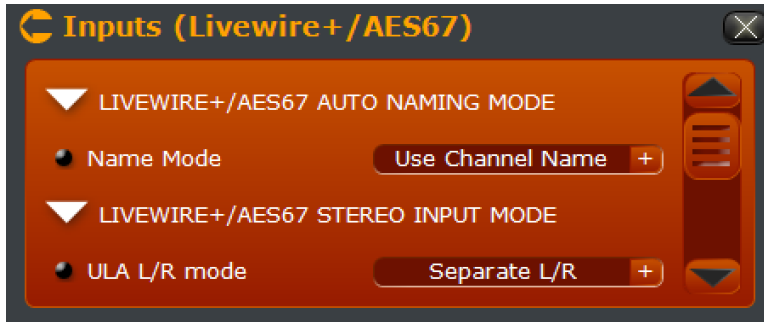

Livewire+/AES67 Auto Naming Mode

Name Mode

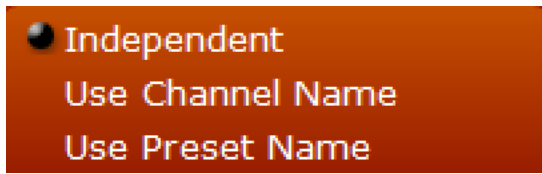

Determines the source for the name of each AoIP input. By default, the names are independent and will be configured in the settings for each input. “Use Channel Name” will automatically name the AoIP input with the channel name, and “Use Preset Name” will use the name of the preset loaded on that channel.

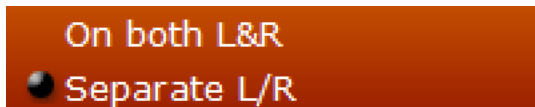

Controls the audio configuration for AoIP inputs. When set to “On both L&R”, audio from the incoming stream is duplicated on both left and right channels. The result is essentially 8 mono AoIP input channels. When set to “Separate L/R”, there are 4 stereo AoIP inputs. Behavior in this mode is similar to the AES inputs (AoIP input 1 Left will feed Channel 1, AoIP input 1 Right will feed Channel 2, and so on).

Livewire+/AES67 Input Configuration Note

The AoIP inputs can be configured in a number of different ways, supporting Livewire or AES67. Inputs can also be configured to allow “split stereo” audio with separate L/R channels, or in mono with the same audio on both left and right channels. The options displayed in these sections will change depending on how the “ULA L/R Mode” and “LAN Mode” parameters are configured.

Livewire+ {x} 1-4 or 1-8

Controls settings for each of the AoIP inputs when set to Livewire mode.

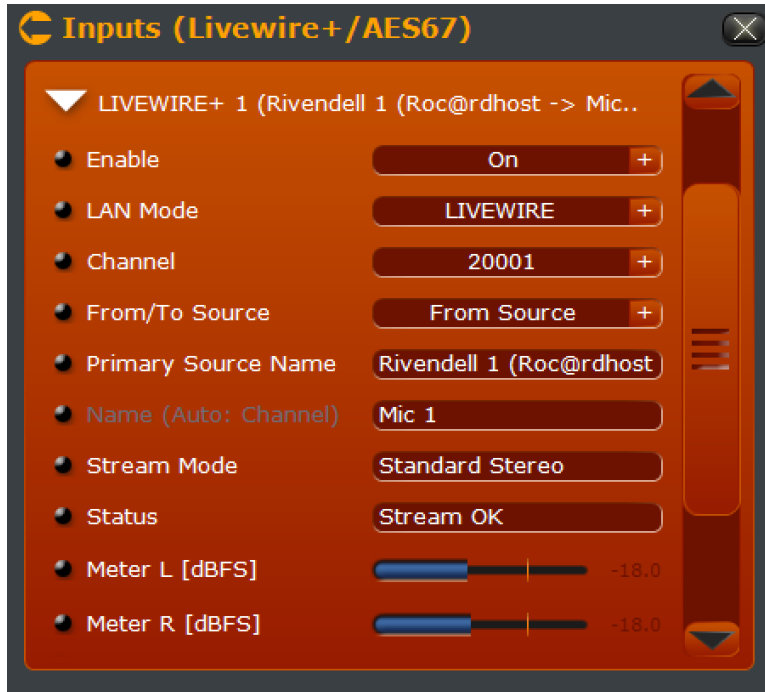

Enable

Enables or disables the AoIP input channel.

LAN Mode

Selects Livewire or AES67 mode. The options in this section will change depending on which mode is selected.

Channel

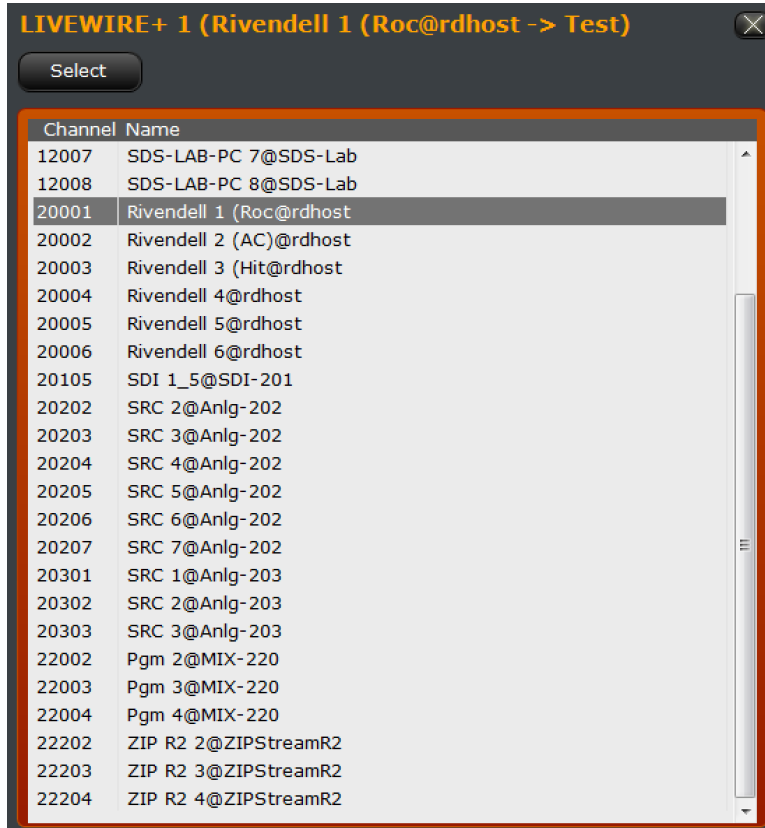

Enter the desired Livewire channel to receive on this input. Click the “+” to display a list of available channels on the AoIP network.

From/To Source

Used for dynamically generating a Mix Minus feed in a Livewire environment. Normally set to “From Source” unless an automatic mix minus feed is required. Refer to the documentation for your Axia console or the Intro to Livewire+ document for more information.

Primary Source Name

Displays the source name and device for the incoming Livewire stream. In this example, a stream named Roc is coming from the device named rdhost.

Name (Local, Auto: Channel, or Auto: Preset)

Displays the current name for this input channel and where the name is being pulled from. This will be determined based on the “Name Mode” setting. When the “Name Mode” is set to “Independent” a name can be entered locally into this field.

Stream Mode

Displays the mode of the incoming Livewire stream. For most applications involving microphone processing, you will want this to be “Live” rather than “Standard”. If you are experiencing latency issues and the VOCO is not receiving a “Live” stream, check the settings at the source.

Status

If a stream is being received properly, this should display “Stream OK”. If there is no stream on the specified channel, the status will display “Nothing Received”.

Meter, Meter L, Meter R [dBfs]

Provides confidence metering for the incoming AoIP stream. If the “ULA L/R Mode” is set to “On both L&R” a single meter will be displayed for the mono audio generated from the incoming stream. If the “ULA L/R Mode” is set to “Separate L/R” a pair of meters will be displayed for left and right channel audio from the incoming stream.

AES67 {x} 1-4 or 1-8

Controls settings for each of the AoIP inputs when set to AES67 mode.

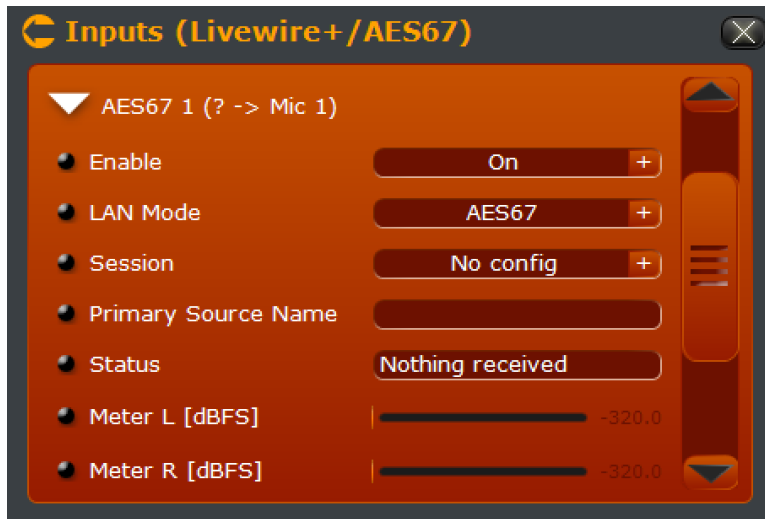

Enable

Enables or disables the AoIP input channel.

LAN Mode

Selects Livewire or AES67 mode. The options in this section will change depending on which mode is selected.

Session

Enter an RTSP URL. “rtsp://<host>[:port]/by-name/<session name>”

Name (Local, Auto: Channel, or Auto: Preset)

Displays the current name for this input channel and where the name is being pulled from. This will be determined based on the “Name Mode” setting. When the “Name Mode” is set to “Independent” a name can be entered locally into this field.

Primary Source Name

Displays the source name for the incoming AES67 stream.

Status

If a stream is being received properly, this should display “Stream OK”. If there is no stream on the specified session or address, the status will display “Nothing Received”.

Meter, Meter L, Meter R [dBfs]

Provides confidence metering for the incoming AoIP stream. If the “ULA L/R Mode” is set to “On both L&R” a single meter will be displayed for the mono audio generated from the incoming stream. If the “ULA L/R Mode” is set to “Separate L/R” a pair of meters will be displayed for left and right channel audio from the incoming stream.

Outputs (Digital/Livewire+/AES67)

Configures the AES and Livewire+/AES67 AoIP output channels including channel naming, audio channel output mode (Livewire+/AES67 only), and channel selection.



AES frequency

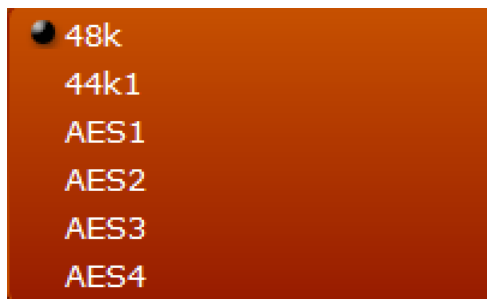

Selects the sample rate of the AES outputs. Available options are 48 kHz, 44.1 kHz, and locking to a reference signal from any one of the four AES inputs.

Livewire+/AES67 Auto Naming Mode

Name Mode/Label Mode

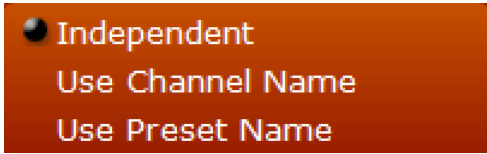

Determines the source for the name of each output sent to the AoIP network. By default, the names are independent and will be configured in the settings for each output. “Use Channel Name” will automatically label the AoIP output with the channel name, and “Use Preset Name” will use the name of the preset loaded on that channel. “Name” and “Label” are used in different ways on the AoIP network to identify channels. Experiment with both (or set them the same) to see which method is best for your installation.

Livewire+/AES67 Stereo Output Mode

ULA L/R Mode

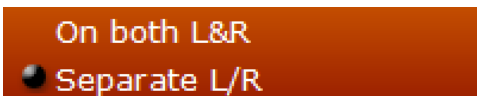

Controls the audio configuration for AoIP outputs. When set to “On both L&R”, audio sent on the output stream is duplicated on both left and right channels. The result is essentially 8 mono AoIP output channels. When set to “Separate L/R”, there are 4 stereo AoIP outputs. Behavior in this mode is similar to the AES outputs (Channel 1 will feed AoIP output 1 Left, Channel 2 will feed AoIP output 1 Right, and so on).

AoIP Output Configuration

The AoIP outputs (like the inputs) can be configured in a number of different ways—Livewire, AES67, separate L/R audio, or same audio on L&R. The options displayed for these outputs (and the number of outputs) will vary depending on how the “Profile” and “ULA L/R Mode” parameters are set.

Livewire {x} 1-4 (Livewire mode, Separate L/R audio)



Livewire {x} 1-8 (Livewire mode, Same audio on L&R)

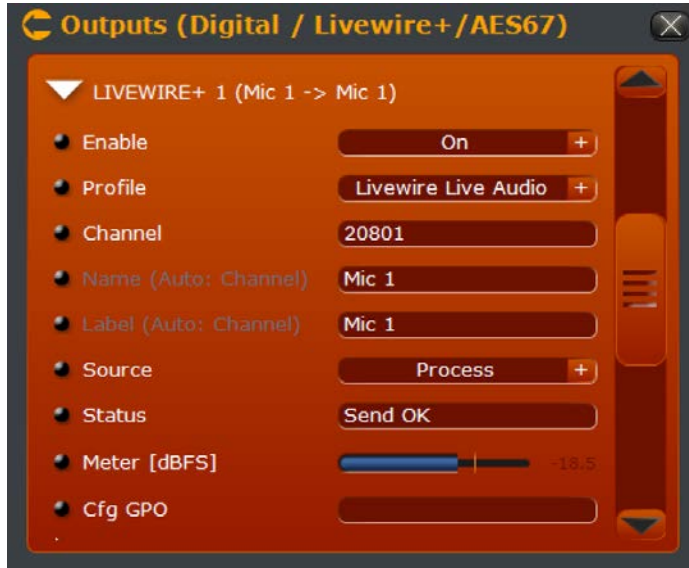

Enable

Enables or disables the AoIP output channel

Profile

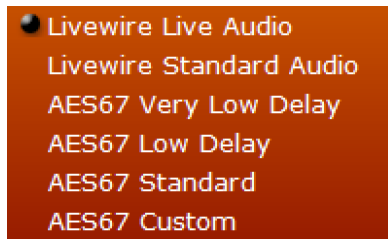

Selects which “Profile” to use for this AoIP output channel. The available options will change depending on which profile is selected. The AES67 profiles can be defined through the “Advanced” setup menu in the “Admin” account.

Channel

Defines which Livewire channel will be used for this AoIP output.

Name/Label (Local, Auto: Channel, or Auto: Preset)

Displays the current name and label for this input channel and where that information is being pulled from. This will be determined based on the “Name Mode” and “Label Mode” settings. When the “Name Mode” or “Label Mode” is set to “Independent” names can be entered locally into these fields.

Source (Left/Right)

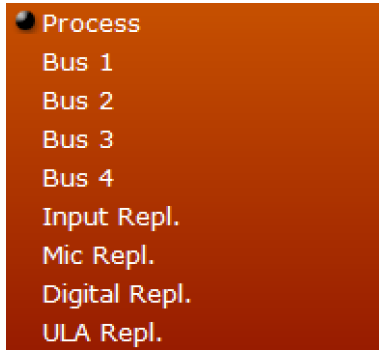

Selects the source applied to the channel’s AoIP output. Channel mappings for these settings will change depending on how “ULA L/R Mode” is configured. When the AoIP channels are configured for stereo (Separate L/R) , two fields will appear—one for the left channel, and one for the right. These will map to even and odd mono source channels correspondingly. When the AoIP channels are configured for mono (Same on both L&R) , the mapping should be 1:1, with the exception of the four AES digital inputs, which are always treated as “split” stereo.

Process

Routes post-processor audio to the AoIP output.

Bus 1-4

Routes the selected mix bus to the AoIP output.

Input Repl.

Routes the selected processor input signal (analog, digital or ULA) to the AoIP output.

Analog Repl.

Routes the analog input directly to the AoIP output.

Digital Repl.

Routes the digital input directly to the AoIP output.

ULA Repl.

Routes the ULA (AoIP) input directly to the AoIP output.

CFG GPO

This field is for configuring GPIO logic to AoIP networks and is not currently implemented.

AES67 {x} 1-8 (AES67 mode, Same audio on L&R)

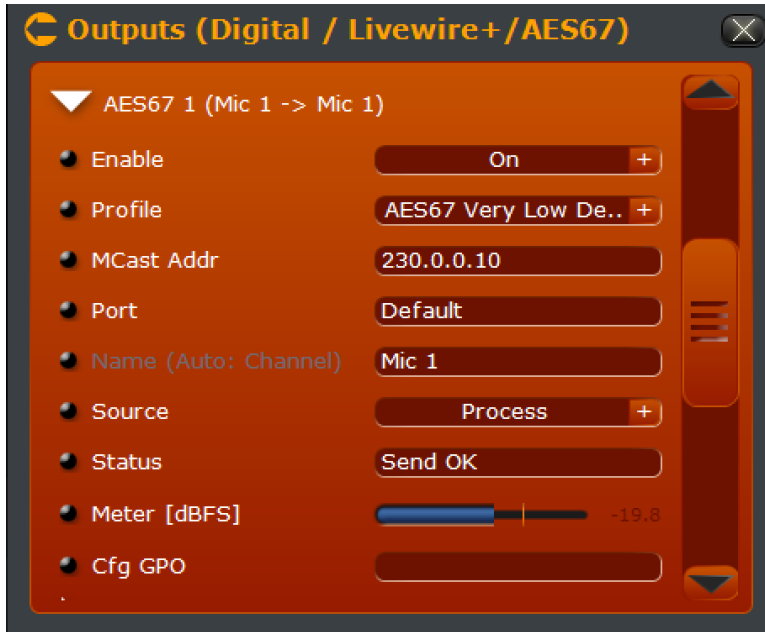

When the “Profile” is switched to AES67, several options change. The 4 or 8 AoIP outputs (depending on ULA L/R mode) can be set for any combination of AES67 and Livewire.

AES67 Profile Specific Options

MCast Addr

Enter the desired multicast address for this AoIP output. The preferred range is 239.0.0.0 to 239.255.255.255.

Ensure that you are using a unique multicast address on the network and not overlapping with any existing traffic.

Livewire, for example, uses 239.192.0.0 through 239.196.255.255 for streams and 239.192.255.x for control. Refer to “Introduction to Livewire+” document at <http://www.telosalliance.com/lwintro> for details.

Port

Enter the desired port for the multicast traffic, or leave set to default.

AES67 {x} 1-8 (AES67 “Custom” mode, Same audio on L&R)



When the profile is set to “AES67 Custom”, additional options appear that allow you to override the default profile settings configured through the admin account.

AES67 “Custom” Profile Specific Options

Sample Format

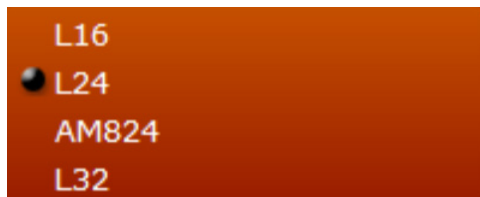

Supported formats for AES67 profiles are 16 bit, 24 bit, and 32 bit linear. AM824 is a 32 bit format with 24 bits of audio data and 8 bits for AES3 side-band data. The format was proposed but never fully standardized. It is included here for experimental purposes only.

Packet Length



Adjusts the AoIP packet length in samples. A shorter length results in lower latency with higher bandwidth overhead. Longer lengths have more latency but a lower bandwidth overhead.

Headphone Output

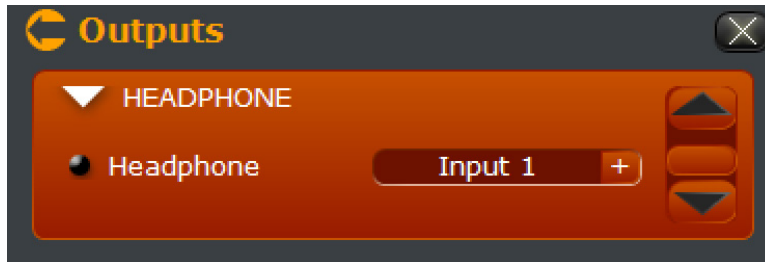

Selects the audio routed to the front panel headphone jack.

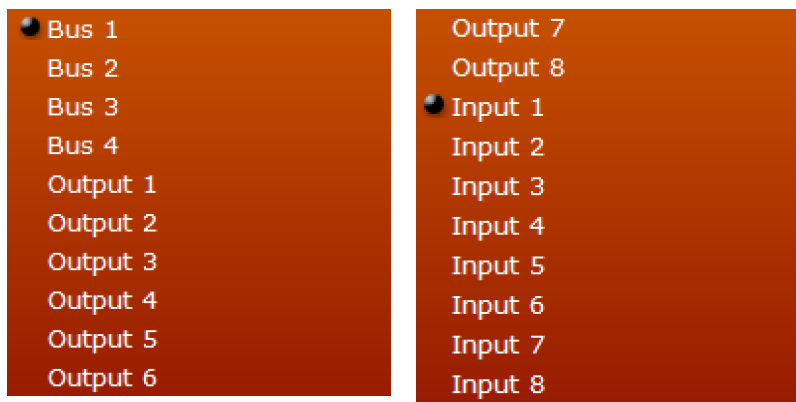

The four mix buses and the processor channel inputs and outputs can be routed to the headphones. Physical inputs and outputs are not available directly—The headphone input and output selections will follow whatever is routed through the processor channels.

Licenses

This interface is identical to the one available through the “Admin” account. License keys enable additional processing channels and other features on the VOCO 8. The “base” VOCO 8 is licensed for 2 channels of processing and supports up to 8. All licenses for features purchased with the unit should have already been loaded at the factory.

The “Licenses” section of setup allows new license keys to be loaded on the system in the field if any additional features are purchased at a later date. This screen also displays the serial number and MAC addresses of the VOCO, which will be required for the new license keys to be generated.

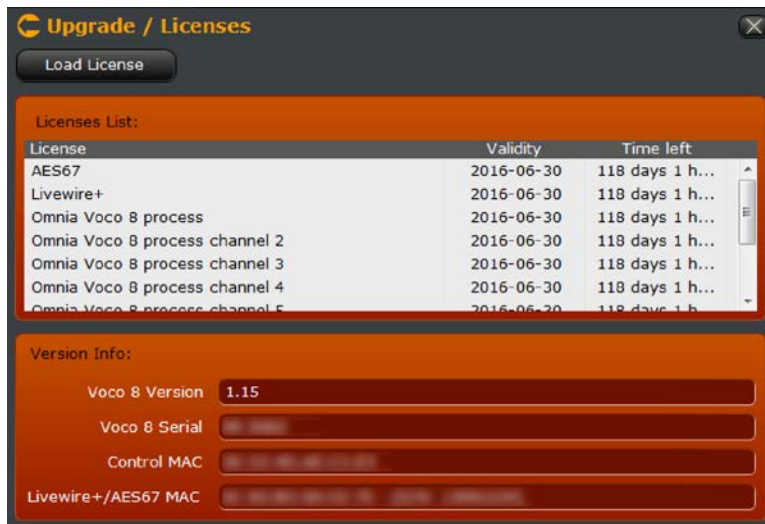

To load a new license, click “Load License” and locate the file. The license key is delivered as a ZIP file. Do NOT unzip this file. It will be loaded directly into the system. Once the license file has been loaded, the added licenses and features should appear in this window. If the expected features do not appear or if there is any issue loading the license file, contact technical support.

Maintenance

From the “Studio” account, only the “Log Ethernet” feature is available through the Maintenance window.

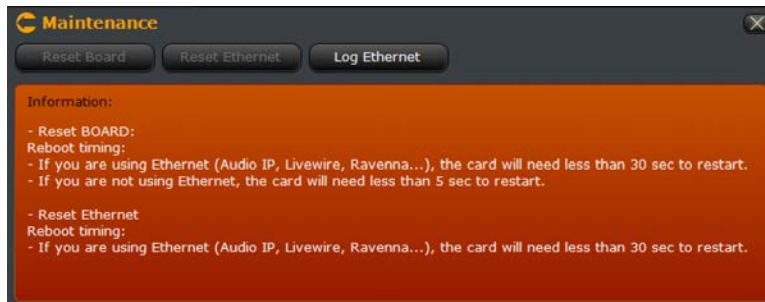

To view Ethernet interface diagnostic logging information, click “Log Ethernet”.

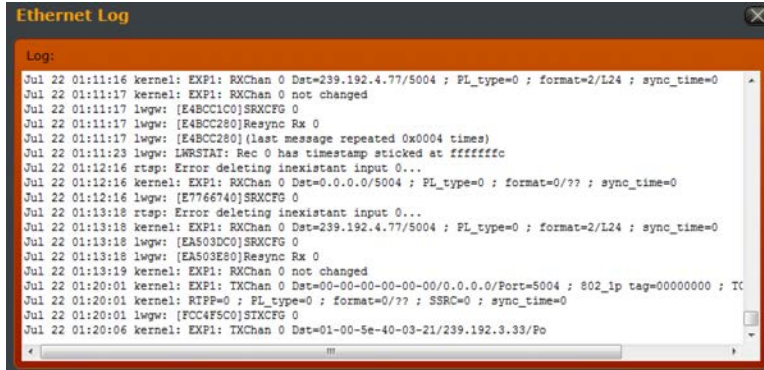

This information can be useful in troubleshooting AoIP and other issues.

10 Navigating the “Studio” Interface

Overview

The previous chapter covered the “Setup” options available through the Studio account and gave a brief look at a few elements of the interface. This chapter will go into further detail about navigating the interface.

Main Window

The main portion of the window (below the channel status display, about, setup, and window controls) contains two major components. On the left hand side is an overview of the processing structure and audio routing. The remainder of the window contains the main controls for session and preset management, as well as audio processing adjustments.

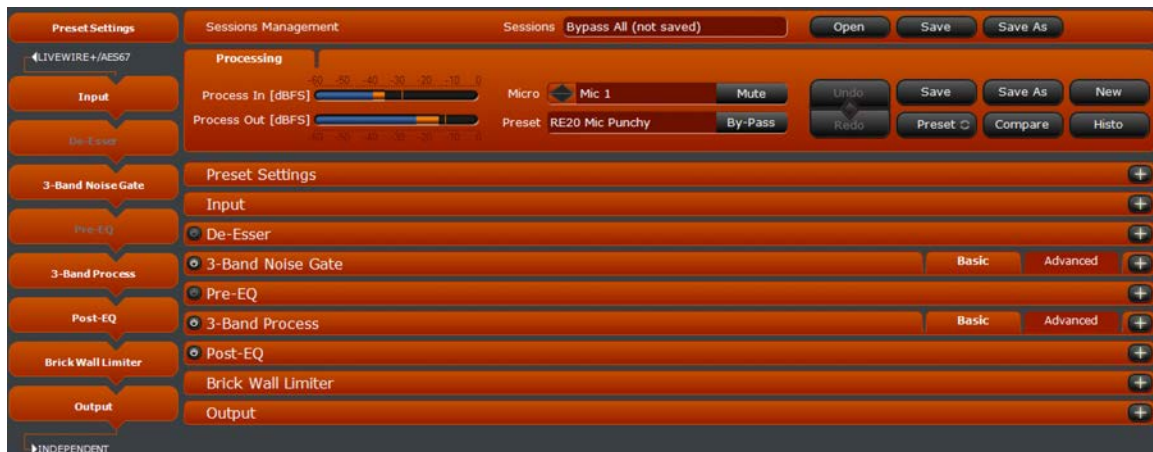

Processing Structure

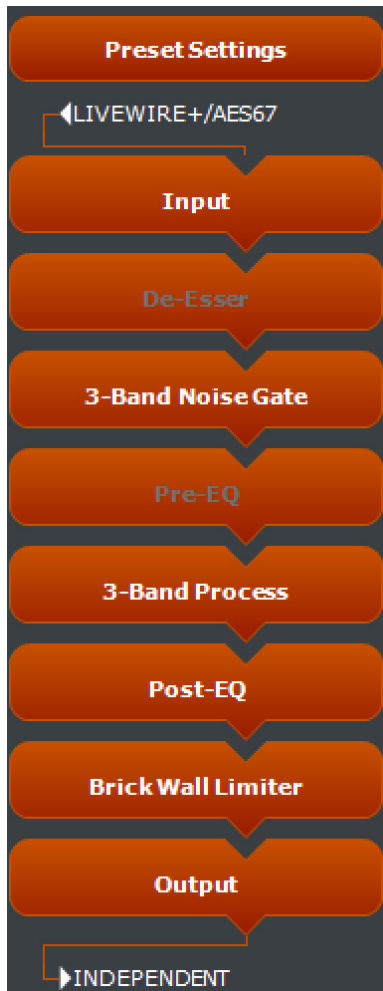

This panel displays an overview of the entire processing structure for the selected channel and preset. (A quick refresher—You can select a channel by clicking on it in the channel overview at the top of the window. All channels with the same preset loaded will be selected simultaneously.)

In this example, we see that the “Livewire+/AES67” input is the source for the selected channel’s processing chain. The “De-Esser” and “Pre-EQ” portions are greyed out, indicating that they are currently bypassed.

At the end of the chain, the output path is displayed. “Independent” indicates that this input is assigned to the associated output (Input 1 to Output 1, etc) . If the channel is assigned to one of the four mix buses, it will be displayed here.

When running higher screen resolutions, metering and additional information about the selected channel’s preset will be displayed as well.

In addition to displaying information about the processing chain, this panel can be used to navigate through the main portion of the window. Click on any block to jump directly to that section of the controls. Control sections that are currently visible in the window will have a red background. If any section of the controls is not currently visible, it will have a dark grey background.



Preset settings, Input, De-Esser, 3-Band Noise Gate, and Pre-EQ are visible here. The remaining processing blocks are not visible.



If you click on the 3-Band Process section, the 3-Band Process, Post-EQ, Brick Wall Limiter, and Output sections become visible on screen while hiding the Preset Settings, Input, De-Esser, 3-Band Noise Gate, and Pre-EQ. The Session Management controls and the “Processing” tab for preset management are always visible.

Controls



This portion of the window is where the majority of processing configuration takes place. For the preset settings and processing control sections, each section can be expanded by clicking the **+** on the right hand side. If the section is already expanded, the control will change to **-**. Click to collapse that portion of the controls.

Each processing section also has a small “power button” on the left hand side. When illuminated, that section is enabled. **⏻** If the section is bypassed, the button will be dark. **⏻** Click to bypass or enable each section individually. The final brick wall limiter is the only section that cannot be completely bypassed.

Sessions Management (Chapter 11)

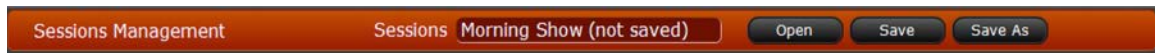

The Sessions Management panel is used to save and load “sessions”. A session is a “snapshot” of presets loaded on channels. This panel is always available on the screen.

Processing Tab (Chapter 11)



This tab displays an overview of the currently selected channel’s input and output levels and the currently loaded preset. All preset management functions are performed through this tab and it is always visible on the screen. Session and preset management will be covered in more detail in Chapter 11.

Preset Settings (Chapter 12)



Controls various “global” parameters that are stored with each preset such “Dominate-it”, Low-pass, High-pass, and processing band frequencies, phase rotation, and polarity invert.

Processing Controls (Chapter 13)

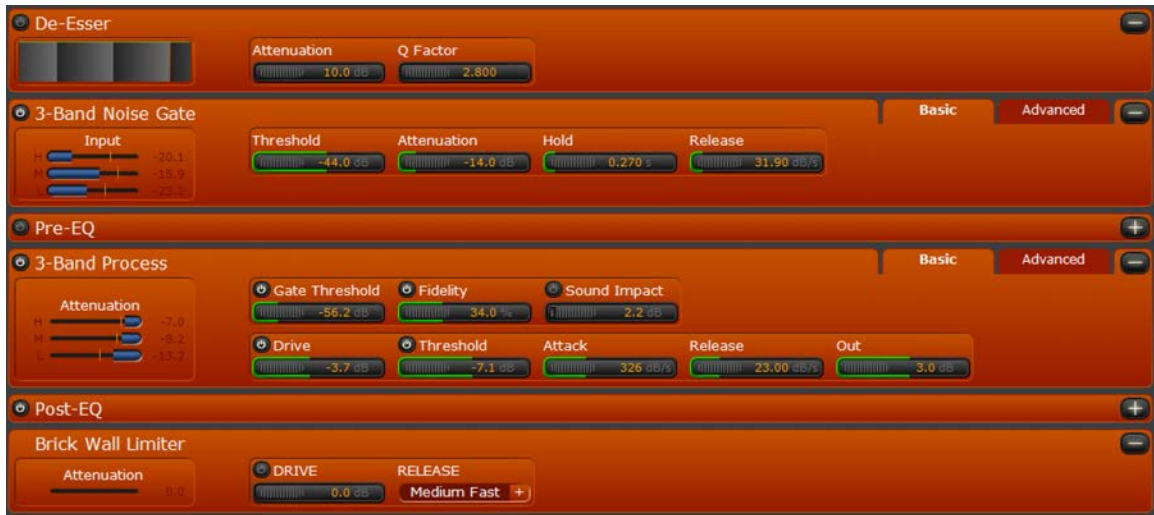

These controls adjust the parameters for each processing section. All parameters will be saved with the preset. Any adjustment made on channels with the same preset loaded will affect them all simultaneously.



The 3-Band Noise Gate and 3-Band Processing sections also have “Advanced” tabs, which allow fine adjustment of the 3 bands of processing individually. The processing parameters will be covered in detail in Chapter 13.

11 Session and Preset Management

Overview

The VOCO 8 offers a very powerful preset and session management system. Presets allow nearly every aspect of the processor to be stored and recalled on a channel-by-channel basis and can be loaded on multiple channels simultaneously. A single preset loaded on multiple channels will allow parameters on all of those channels to be modified simultaneously. This includes not only processing parameters, but also things like mix bus assignments and the “Dominate-it” function for mic channels that should take priority over others. “Sessions” create a snapshot of the presets that are loaded on channels at a given point in time can recall those presets on all 8 channels at once—a very useful function for managing different shows or studio configurations. This chapter will cover how to manage both sessions and presets. Chapter 12 will go into more detail about the settings stored in presets.

Session Management

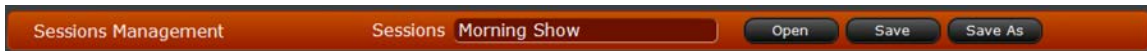

Unlike the “Live” account, the “Studio” account allows you to both recall AND save sessions.

Saving a session

Although there are various presets loaded on the channels from the factory, there are no sessions saved on the VOCO 8 by default. To save a session, first ensure that the desired presets are loaded on each channel (as described in the “Preset Management” section of this chapter).

Hint:

Save sessions and presets with a uniquely identifiable first character, perhaps related to the show, studio, microphone, or host that they are typically used for.

Click “Save As” in the session management bar. A list of existing sessions (if any) will appear on the left hand side of the window. Use the up and down arrows to scroll through the list. Enter a name for the session. To save as an existing name, click on it in the list. Click OK to save the session.



To save a currently open session under the same name, click “Save” rather than “Save As”. The “Save” and “Save As” functions are also available from the “Open” dialog box.

Opening a session

To open a session from the session management bar, click the name area next to “Sessions” or click “Open”.



The dialog box that appears will allow you to search for sessions by the first character of the name. The currently loaded session will be highlighted in orange. Click on a character to search, or click “All” to show all available sessions. Use the up and down arrows to scroll through the list if necessary.



Clicking “M” will display all sessions beginning with that letter.

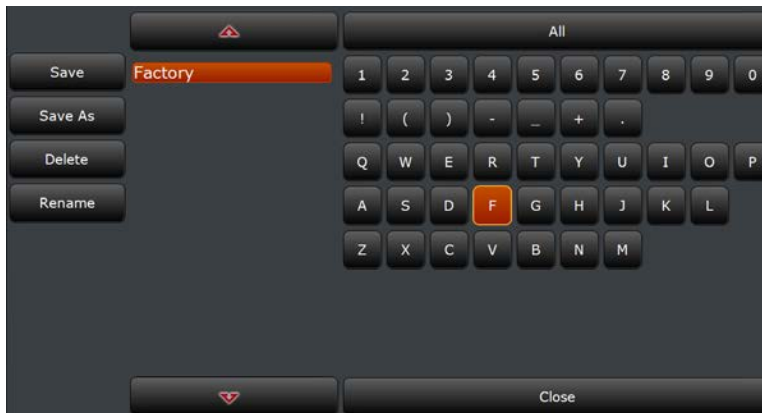

Clicking on another character will search for sessions beginning with that character instead. Click “All” to clear the search and display the entire list.

Once you have located the session, click on the session name from the list to open it or click “Close” to return without opening a session.

Deleting and Renaming Sessions

The delete and rename functions are available through the same dialog box that opens a session. To delete or rename a session from the session management bar, click the name area next to “Sessions” or click “Open”.

Deleting a session

Click the “Delete” button, and then click the “X” next to the session you wish to delete. Scroll through the list with the up and down arrows or search by first letter if necessary. To cancel without deleting a session, click the “Delete” button again, or click “Close”.



Renaming a session

Click the “Rename” button, and then click on the session you want to rename.



Enter the new name and click OK, or click cancel to return without renaming the session.



Preset Management



All preset management is done through the “Processing” tab. The center section of the tab selects a microphone channel and preset, the right hand buttons control all other preset management functions.

Loading Presets on Mic Channels

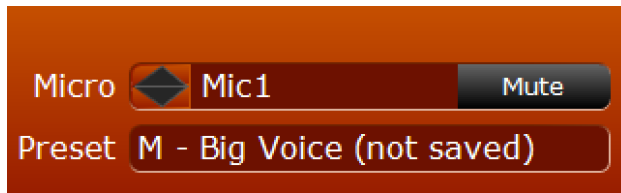

To select a microphone channel, either click on it in the channel status display at the top of the window, or select it from the processing tab. Use the arrows to scroll through the microphone channels or click on the channel name and select a microphone channel from the list.

Note:

Microphone channel names can be changed by a “long click” on the current mic name. Hold the mouse button down for 3 seconds and the current name will be highlighted for editing.

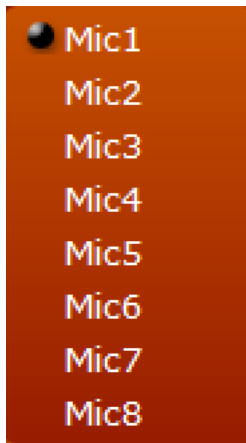

To load a preset on the selected microphone channel, click the preset name underneath the microphone channel to display a list of available presets. Scroll through the list using the up and down arrows, or click a character to search for preset names starting with that character. Click on “All” to clear the search and display all presets. Click on a preset name to load it, or click “Close” to return without loading a preset.



Preset Controls



Undo/Redo

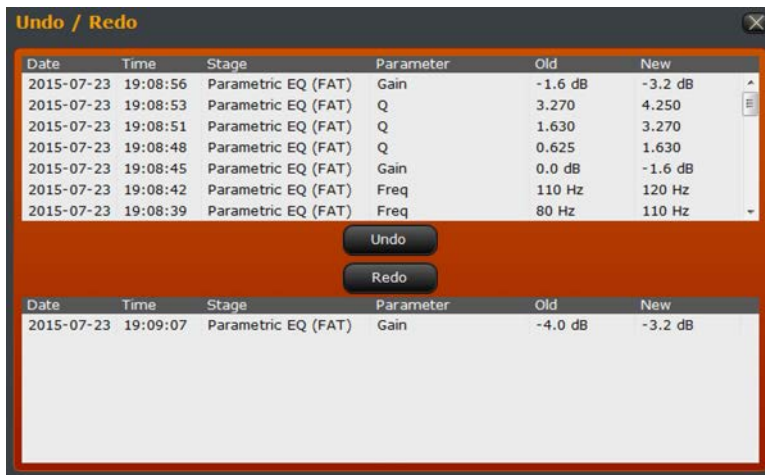

Tracks all changes made to a preset with multiple undo/redo levels. Click on undo to step back one change at a time or redo to step forward. Click the “diamond” in the middle of the two controls to open the undo/redo list.

Save

Saves changes to the current preset without changing the name. The preset name will indicate (not saved) if there are unsaved changes.

Save As

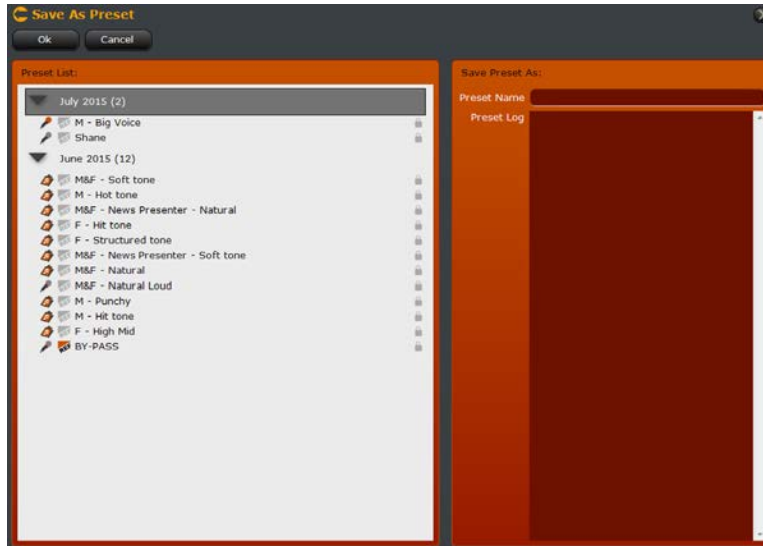

Saves the current preset with a new name. Enter the new name in “Preset Name”. Click OK to save or Cancel to return without saving.

New

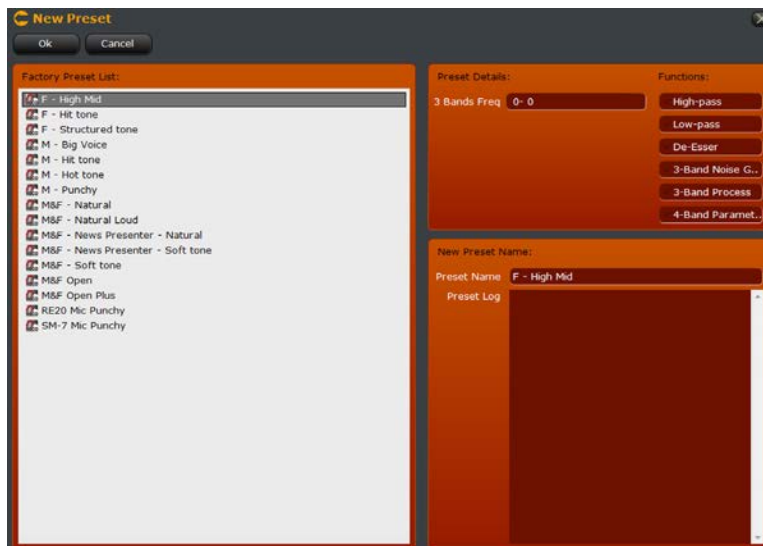

The VOCO 8 contains two lists of presets—USER and FACTORY. Most areas of the software display the USER list of presets, which contains a copy of the FACTORY presets. The NEW dialog box is the only area of the software that will exclusively display the FACTORY presets. These presets can never be overwritten but they can be used as the basis for new presets. The factory presets are detailed in Chapter 14.

The “Preset Information” section displays the frequencies of the processing bands and processing sections that are enabled by default. Choose a preset and enter a new name in the “Preset Name” field. Click “OK” to create the new preset or “Cancel” to return without creating a new preset.

Preset

Accesses the “user” preset list. The icon on the “Preset” button indicates whether or not preset sharing is enabled—if it is enabled, presets from all other units with preset sharing enabled will appear in the list.

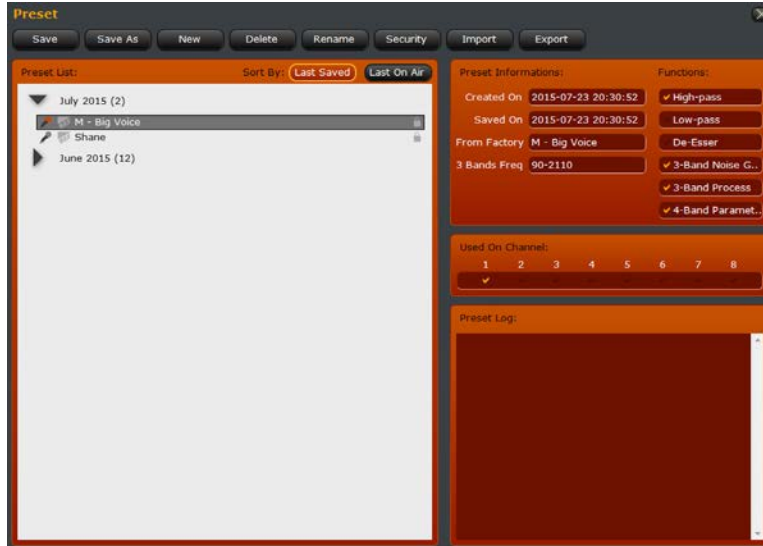

The list is sorted by date last saved or date last used “on air” (assigned to a microphone channel) . Information about each preset including date created, date last saved, factory preset it was created from, processing frequency bands, and processing sections enabled is in the “Preset Information” section.

The “Padlock” icon on the right of the list will illuminate orange if security is enabled on a preset.

The “Microphone” icon indicates that the preset is loaded on one or more channels. If the microphone icon is orange, it indicates that preset is loaded on the currently selected channel. The channels the preset is loaded on will be indicated on the right in the “Used On Channel” section. Double-click another preset to load it on the currently selected channel.

Save/Save As/New

These controls function identically to the preset management controls on the “Processing” tab.

Delete

Deletes the selected preset. You cannot delete a preset that is currently used on a channel. Ensure that the preset is not in use before attempting to delete it.

Rename

Renames the selected preset. Click Rename, then enter a new name for the preset and hit return. Hit return again to confirm.

Security

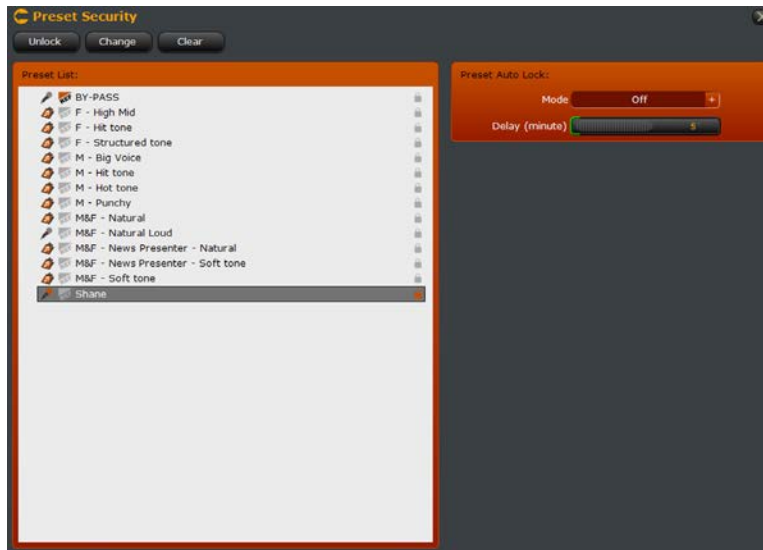

Manages security on presets and automatic locking of presets. Select a preset in the list to manage. Once a password is set, the padlock on the right will change to orange.

Lock/Unlock

Unlocks or re-locks a preset. The existing preset password is required to unlock the preset. If the preset has a security password set but is currently unlocked, click “Lock” to re-lock the preset. The preset will also re-lock automatically after the specified time period if “Preset Auto Lock” is enabled.

Set/Change

If a preset does not have a password set, click “Set” to set one. Click “Change” to modify an existing password. You will need to have the existing password for a preset in order to change it.

Clear

Clears the password on a preset if one is set. You will need the existing password for a preset in order to clear it.

Import/Export

Imports or exports a preset from a file for use in other VOCO 8 units.

Compare

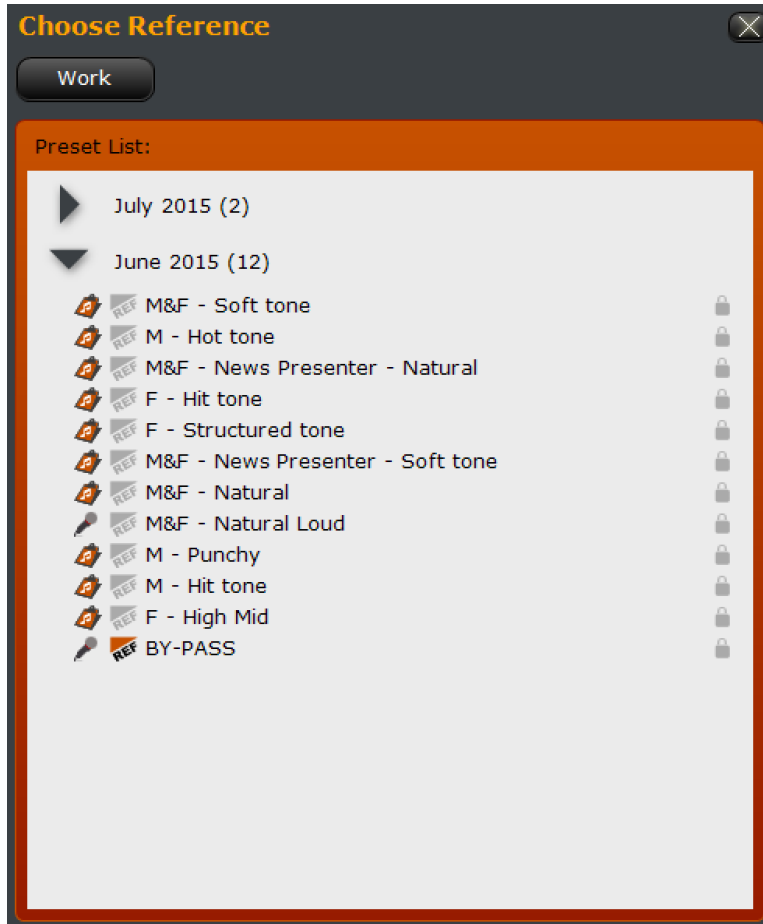

Compares the current channel's "working" preset with another "reference" preset side by side. Double-click a preset in the list to set it as the "reference" preset. The "Ref" icon will be illuminated by the "Reference" preset. Click the "Work" button at the top to toggle between the "Work" and "Reference" presets. The "Reference" preset may also be changed while it is being auditioned.

Preset History

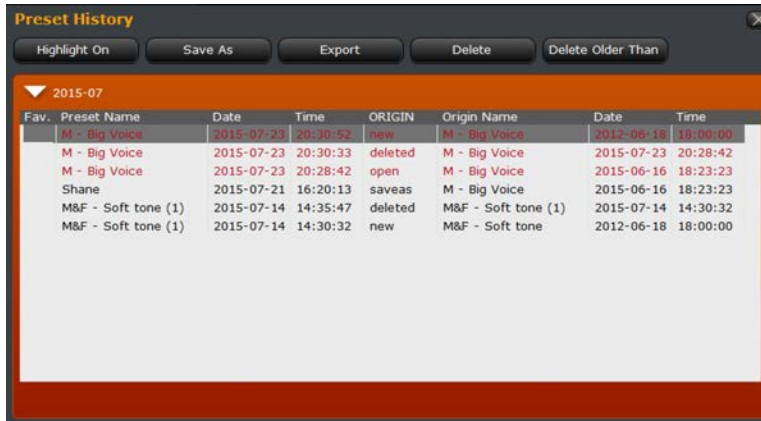

Maintains a complete record of all changes made to presets and allows those changes to be saved as new presets, or exported to a preset file.

Highlight On/Off

Enables or disables highlighting for groups of changes made to the same preset.

Save As

Saves the selected item as a new preset.

Export

Exports the selected item as a preset file for use on another VOCO 8 unit.

Delete

Deletes the selected item from the history.

Delete Older Than

Deletes all items older than the selected item.

12 “Preset Settings” Tab

Overview

The “Preset Settings” tab controls several filter related parameters stored in each preset. The unique “Dominate-it” feature is also controlled through the preset settings.

Preset Settings Tab

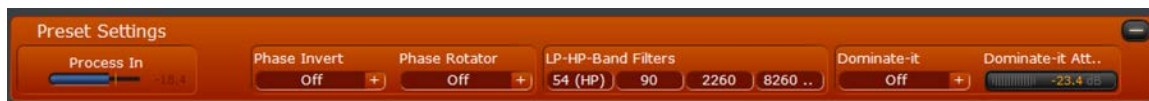

Input Meter



Displays the input level for the selected channel and preset.

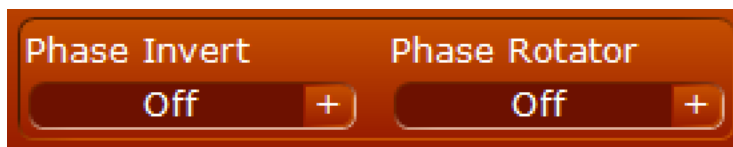

Phase (polarity) Invert

Inverts the absolute polarity of the incoming signal.



Phase Rotator

Increases symmetry on asymmetrical waveforms (such as voice). This in effect reduces the amount of peak energy in the waveform and can make it easier for downstream processing to deal with, resulting in increased loudness and clarity.

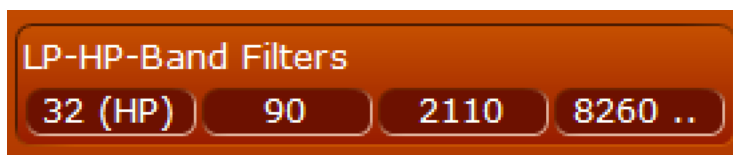
LP-HP Band Filters

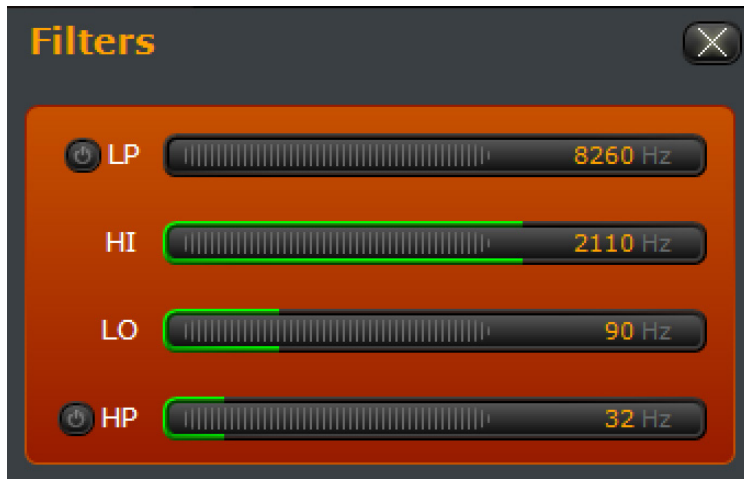



Click on the values to open the “Filters” window. These values adjust the low pass and high pass filter frequencies as well as the high and low band frequencies for the 3-band noise gate and processing. Click  to enable the high pass or low pass filter. If the filter is already enabled, click  to bypass.

Dominate-it



Perhaps one of the “signature” features of the VOCO 8, Dominate-it allows one or more microphones with this feature enabled to automatically “dominate” the mix when speaking by attenuating the audio level of any microphone channels without this feature enabled. The target amount of attenuation applied to the other channels is adjustable.

13 Adjusting Processing Parameters

Overview

Now we get to the good stuff—and what most of you probably purchased the VOCO 8 for in the first place! This chapter of the manual covers adjustment of the processing. These parameters will be stored and recalled with each preset. Once again, all channels with the same preset loaded will be adjusted simultaneously.

This isn't your "typical" mic processor so you may not get the sound you're "used to" on the first shot. Over time and with some experimentation, you should be able to achieve exactly what you're looking for!

We'll also cover configuration of input and output parameters in this section (mic/line/AoIP input selection, phantom power, pad, gain, bus assignments, output selection, etc).



Processing Sections

The screenshot displays the VOCO 8 software interface, which is organized into several processing sections. The interface is dark-themed with orange and grey accents.

- Input:** Shows 'Process In' at -30.7, 'Input' set to 'LIVEWIRE+..', and 'Reference' at 0.00 dBFS.
- De-Esser:** Features a frequency response graph, 'Attenuation' at 10.0 dB, and 'Q Factor' at 2.800.
- 3-Band Noise Gate:** Includes a 'Basic' and 'Advanced' toggle. The 'Basic' view shows 'Input' levels (H: -46.6, M: -29.6, L: -44.8), 'Threshold' at -44.0 dB, 'Attenuation' at -14.0 dB, 'Hold' at 0.270 s, and 'Release' at 31.90 dBFS.
- Pre-EQ:** Features an 'EQ' graph and four frequency bands: 'FAT EQ' (60 Hz, 1.580 Q, 0.0 dB), 'LOW EQ' (200 Hz, 8.272 Q, 0.0 dB), 'MID EQ' (2000 Hz, 2.000 Q, 0.0 dB), and 'HIGH EQ' (8000 Hz, 1.663 Q, 1.6 dB).
- 3-Band Process:** Includes a 'Basic' and 'Advanced' toggle. The 'Basic' view shows 'Attenuation' (H: -5.5, M: -5.7, L: -7.3), 'Gate Threshold' at -56.2 dB, 'Fidelity' at 34.0 %, 'Sound Impact' at 2.2 dB, 'Drive' at -3.7 dB, 'Threshold' at -7.1 dB, 'Attack' at 326 dBFS, 'Release' at 23.00 dBFS, and 'Out' at 3.0 dB.
- Post-EQ:** Features an 'EQ' graph and four frequency bands: 'FAT EQ' (80 Hz, 2.182 Q, 0.0 dB), 'LOW EQ' (150 Hz, 0.800 Q, 0.0 dB), 'MID EQ' (3490 Hz, 1.091 Q, -1.2 dB), and 'HIGH EQ' (9730 Hz, 1.000 Q, 1.2 dB).
- Brick Wall Limiter:** Shows 'Attenuation' at 0.0, 'DRIVE' at 0.0 dB, and 'RELEASE' set to 'Medium Fast'.
- Output:** Shows 'Process Out' at -9.9, 'Output Mode' set to 'Independent', and 'Line Reference' at 15.00 dB. It also includes 'Digital Reference' and 'IP Reference' at 0.00 dBFS, and corresponding 'Application' buttons for Line, Digital, and IP.

In addition to the input and output blocks, there are six sections in the VOCO 8 processing chain: De-Esser, 3-Band Noise Gate, Pre-EQ, 3-Band Processing, Post-EQ, and a final Brick Wall Limiter. The 3-Band Noise Gate and processing sections have an “Advanced” tab that allows access to each band’s individual parameters.

Each section can be individually enabled or disabled. The Brick Wall Limiter is the only section that cannot be entirely disabled. As a result, the output from a processing channel should never exceed 0 dBFS.

To enable a section that is bypassed, click the darkened “power button” . If a section is already enabled, click the illuminated “power button”  to bypass it. This applies to the processing sections overall, and individual components within each processing section.

Each tab can be expanded or collapsed to manage screen real estate while making adjustments. Click the  icon to collapse an open section or the  icon to expand a collapsed section.



Process In

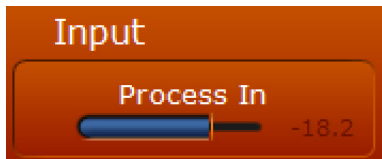

Displays the input level to the processing chain from the selected input.

Input

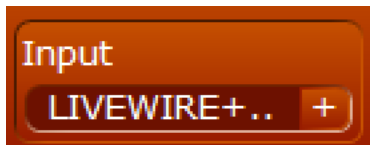

Allows selection of and displays the current input source for the selected processing channel. Gain, sensitivity, and other adjustments will be displayed as appropriate.

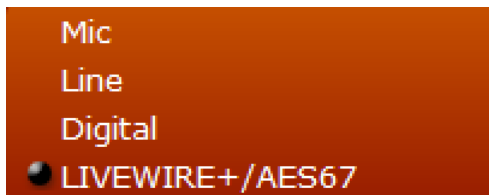

Available input selections are Mic, Line, Digital, and Livewire+/AES67. Each selection will activate the appropriate input level controls and other parameters.

Mic



Selects the microphone input for processing. Allows adjusting Phantom power, pad, and preamp gain.

Phantom Power

Enables or disables 48-volt Phantom power on the microphone input. A red LED will illuminate next to the corresponding input to indicate Phantom power is enabled. If both the pad AND Phantom power are enabled, the LED will be yellow (Note: Later software and hardware revisions use the green or yellow LED condition to indicate whether or not processing is licensed on a channel).

Warning:

Do NOT enable phantom power on inputs where it is not necessary. Damage to the connected equipment may result if it is not wired correctly or not designed to handle the presence of phantom power.

Mic Pad

Enables or disables a -20 dB pad on the mic input. A green LED will illuminate on the rear panel near the corresponding input to indicate the pad is engaged. (Note: Later software and hardware revisions use the green or yellow LED condition to indicate whether or not processing is licensed on a channel).

Preamp Gain [dB]

Sets the microphone preamplifier gain.

Line

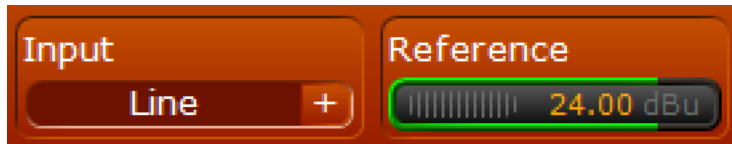

Selects the analog line input for processing.

Reference

Adjusts the internal digital reference level relative to the analog line input signal.

Digital

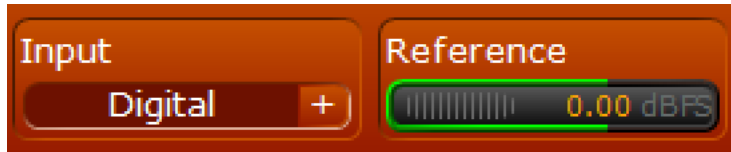

Selects the AES input for processing.

Reference

Adjusts the internal digital reference level relative to the AES input signal.

Livewire+

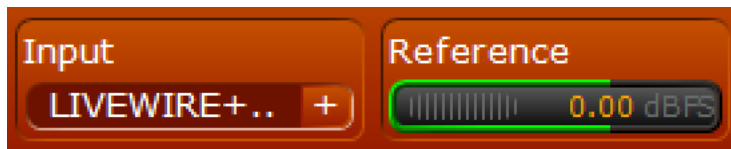

Reference

Adjusts the internal digital reference level relative to the AoIP input signal.

De-Esser



The De-Esser section automatically tracks and attenuates sibilants in the audio. The frequency is determined instantaneously on the fly and does not require manual adjustment. This algorithm is exclusive to the VOCO 8 and can help manage voices or microphones that tend to suffer from excessive sibilance.

Frequency Graph



Displays the frequency response of the De-Esser filter in realtime.

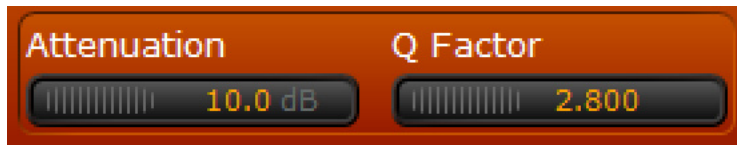

Attenuation

Sets the maximum amount of attenuation automatically applied to detected sibilants.

Q Factor

Adjusts the “width” of the notch created around the detected frequency.

3-Band Noise Gate (Basic Controls)



A unique feature among microphone processors, the VOCO 8 features a 3-band noise gate. This can help to gate noises in specific bands (such as noise generated by doors or countertops) while still passing actual speech. Available parameters are Threshold, Target, Hold, and Release time.

Note:

Unlike traditional gates, which can cut off the first syllable of speech, the attack time on the VOCO 8 gate is virtually instantaneous and is not adjustable.

Metering

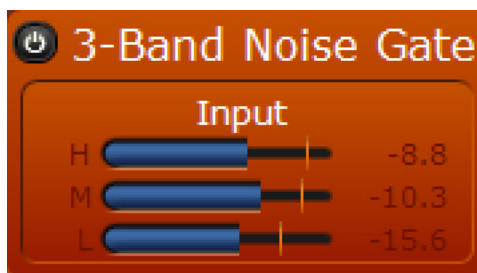

Displays the input level to the gate for each band.



Threshold

Sets the input threshold level at which the gate begins to open.

Target

Sets the target “resting” level of attenuation for the gate when closed. Also known as the “floor” in some other gates.

Hold

Delays the “closing” of the gate by the specified amount of time when the input level falls below the threshold.

Release

Sets the speed (in dB per second) at which the gate closes once the input level falls below the specified threshold and the hold time has passed.

3-Band Noise Gate (Advanced Controls)

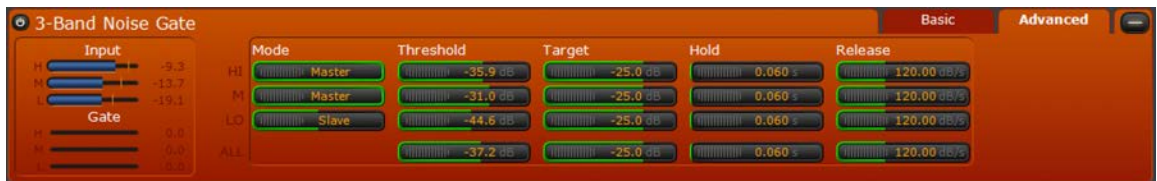

The 3-Band Noise Gate advanced controls are virtually identical to the basic controls but add additional metering, access to band coupling adjustments, and access to each band’s controls individually.

Metering (Advanced)

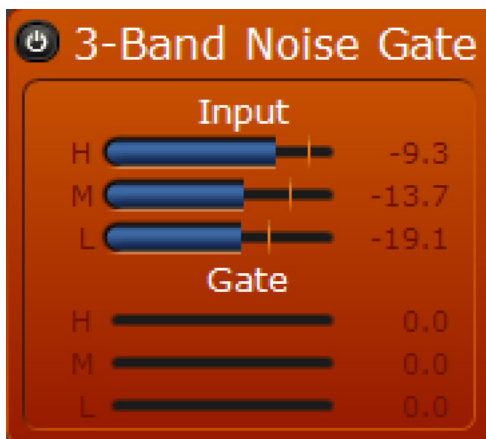

In addition to displaying input levels, the “Advanced” tab displays the attenuation applied by the gate to each band.



Mode

Adjusts the coupling between each band's gate and how the threshold controls interact. This coupling does not directly affect target, hold, or release. Those controls are always completely independent.

When a band is set to "Master" the threshold for that band operates completely independent of the others, but the gate activity for each band (if set to Master or Slave) is still coupled. When set to "Slave" the threshold for that band's gate is slaved to the "Master" bands and has no effect. When set to "Alone" that band's gate activity and threshold is completely de-coupled from the other bands.

If you wanted to essentially emulate a "wideband" gate, for example, you would set the mode of all three bands to "Master" and set the threshold for all three bands identically.

Note:

For the following controls, the advanced tab includes individual adjustments for each band, as well as an "All" adjustment that will modify all three values simultaneously. These "All" controls function the same as the controls that appear on the "Basic" tab.

Threshold

Sets the input threshold level at which the gate for each band begins to open. Depending on how the bands are coupled with "Mode" the behavior and interaction of these threshold controls will change.

Target

Sets the target "resting" level of attenuation for the gate when closed. Also known as the "floor" in some other gates.

Hold

Delays the "closing" of the gate by the specified amount of time when the input level falls below the threshold.

Release

Sets the speed (in dB per second) at which the gate closes once the input level falls below the specified threshold and the hold time has passed.

Pre-EQ



This 4-Band Parametric EQ section allows adjustment of the frequency response prior to the main 3-Band processing section.

EQ Graph Display

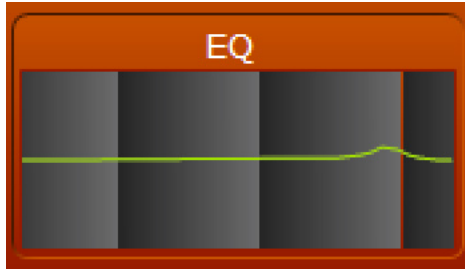

Displays the overall frequency response of the EQ section.



EQ Bands

All four bands are fully parametric and can be set anywhere from 20 Hz to 22 kHz but the default settings line up with the descriptions. All four bands have a “power button” to enable or bypass them (set them flat) individually.

The labeling on the bands is as follows:

- ◆ “FAT EQ” is the lowest band, useful for eliminating problematic rumble or hum frequencies, or adding a little “bump” to make that low end “punch” pop through.
- ◆ “LOW EQ” is helpful for cutting some of the typical low midrange “mud” due to proximity effect or to help enhance that classic “big voice” sound.
- ◆ “MID EQ” can add intelligibility and clarity right in the critical midrange frequencies.
- ◆ “HIGH EQ” will put some “sparkle” in the top end.

EQ Controls

For those not familiar with parametric EQ, a quick overview of the controls...

Frequency

Sets the center frequency of the EQ band. Despite the band labels, each band can be set anywhere on the spectrum from 20 Hz to 22 kHz.

Q

Sets the “bandwidth” of the band’s filter. Lower numbers result in a “wider” filter and higher numbers result in a narrower filter with a sharper “Q”.

Gain

Adjusts the gain of each band.

3-Band Processing (Basic Controls)



This section is the “heart” of the VOCO 8 processing chain. It combines a number of traditional processing parameters with a few features exclusive to the VOCO 8. Like the noise gate, in the “basic” tab, the parameters for all 3 bands are adjusted simultaneously.

Metering

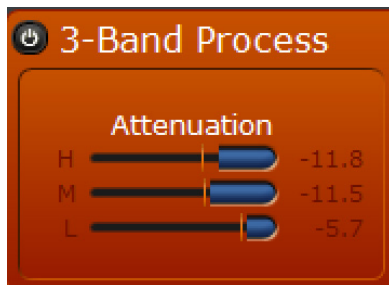

Displays the amount of gain reduction being applied in each of the 3 processing bands.

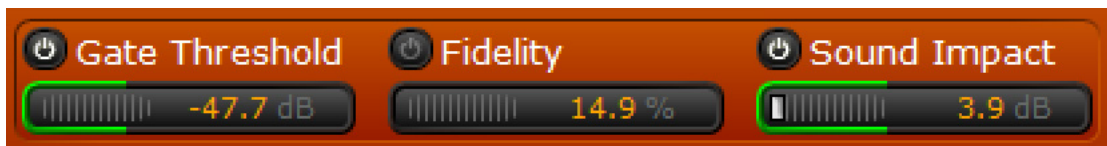

Gate Threshold

Applies a “gate” to the action of the processing section. Below this threshold, the action of the 3 bands is frozen. A “power button” allows this control to be bypassed or enabled individually.

Fidelity

An exclusive feature as part of the integrated 192 kHz Omnia.S4 processing onboard the VOCO 8, the “Fidelity” control works to maintain the fidelity and spectral balance of the original input signal even when processing heavily by proportionally modifying processing thresholds in the background up to the percentage set with this parameter. There will be no direct visible indication of this control’s action but it should make a noticeable difference, particularly with aggressive processing settings. A “power button” allows this control to be bypassed or enabled individually.

Sound Impact

Another exclusive Omnia.S4 feature included in the VOCO 8, the “Sound Impact System” gives the sound more “punch” and “impact” by dynamically adjusting timing constants based on the incoming audio and looking for changes smaller than this setting. An indicator at the end of the control will display when SIS is taking effect. A “power button” allows this control to be bypassed or enabled individually.

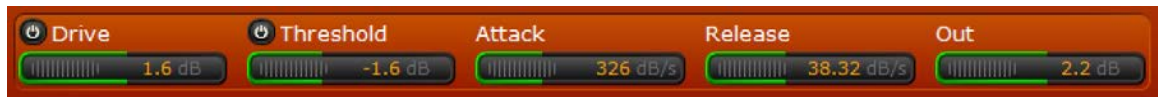

Drive

Applies more or less drive to the 3-Band processing section. A “power button” allows this control to be bypassed (set to 0) or enabled individually.

Threshold

Trims the threshold level where the processing begins to act. A “power button” allows this control to be bypassed (set to 0) or enabled individually.

Attack

Controls the attack time for the 3-Band processing section (in dB per second).

Release

Controls the release time for the 3-Band processing section (in dB per second).

Out

Adjusts the final output level from the 3-Band processing section.

3-Band Processing (Advanced Controls)



The 3-Band processing advanced controls are virtually identical to the basic controls but add additional metering, access to compressor ratio adjustments, and access to each band’s controls individually.

Metering

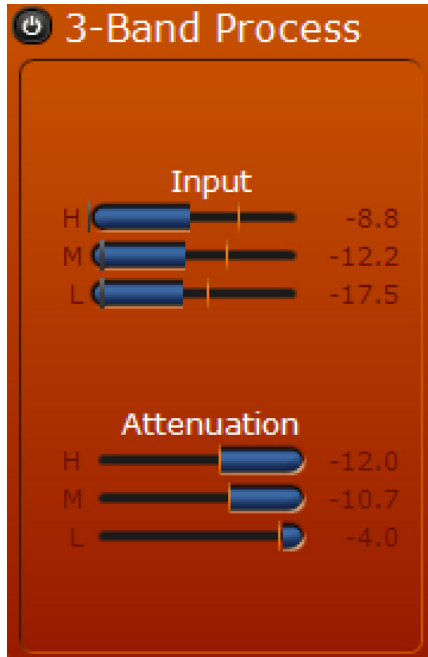

Displays input levels to the 3-Band processing section as well as gain reduction being applied in each band by the processing in this section.

Note:

For the following controls, the advanced tab includes individual adjustments for each band, as well as an “All” adjustment that will modify all three values simultaneously. These “All” controls function the same as the controls that appear on the “Basic” tab (with the exception of “Ratio” which does not appear on the “Basic” tab).

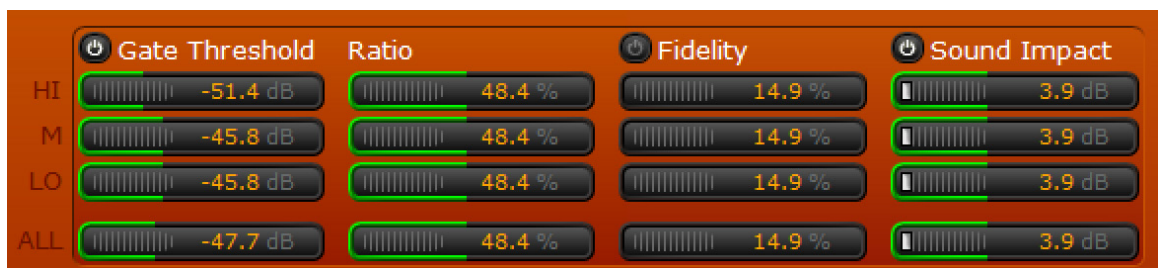

Gate Threshold

Applies a “gate” to the action of the processing section. Below this threshold, the action of the band is frozen. A “power button” allows this group of controls to be bypassed or enabled individually.

Ratio

Sets the compression ratio in each band. Higher percentages are more aggressive and lower percentages are less aggressive.

Fidelity

An exclusive feature as part of the integrated 192 kHz Omnia.S4 processing onboard the VOCO 8, the “Fidelity” control works to maintain the fidelity and spectral balance of the original input signal even when processing heavily by proportionally modifying processing thresholds in the background up to the percentage set with this parameter. There will be no direct visible indication of this control’s action but it should make a noticeable difference, particularly with aggressive processing settings. A “power button” allows this group of controls to be bypassed or enabled individually.

Sound Impact

Another exclusive Omnia.S4 feature included in the VOCO 8, the “Sound Impact System” gives the sound more “punch” and “impact” by dynamically adjusting timing constants based on the incoming audio and looking for changes smaller than this setting. An indicator at the end of the control will display when SIS is taking effect. A “power button” allows this group of controls to be bypassed or enabled individually.



Drive

Applies more or less drive to each band. A “power button” allows this group of controls to be bypassed (set to 0) or enabled individually.

Threshold

Trims the threshold level where the processing begins to act in each band. A “power button” allows this group of controls to be bypassed (set to 0) or enabled individually.

Attack

Controls the attack time for each band (in dB per second).

Release

Controls the release time for each band (in dB per second).

Out

Adjusts the final output levels from each band.

Post-EQ



This second 4-Band Parametric EQ is allows a final “fine tuning” of the sound after the main 3-Band processing section to achieve the desired sonic texture. It functions identically to the Pre-EQ section.

Brick Wall Limiter



The Brick Wall Limiter is the final stage of processing before the output. This is the only stage in the chain that cannot be entirely bypassed. Although the “Drive” control can be turned on and off (set to zero) this stage will not allow the output of the chain to exceed 0 dBFS.

Metering

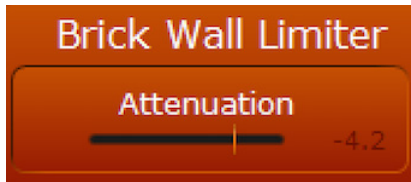

Displays the amount of gain reduction being applied by the final brick wall limiter.



Drive

Trims the amount of drive applied to the final brick wall limiter. This section cannot be completely bypassed but there is a “power button” to essentially set the drive to zero.

Release

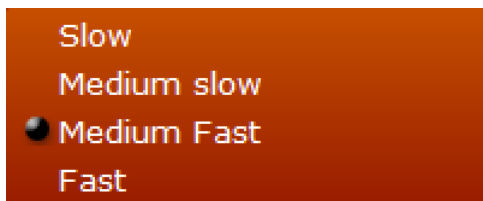

Adjusts the release time of the final limiter section. “Medium Fast” is the default.

Output

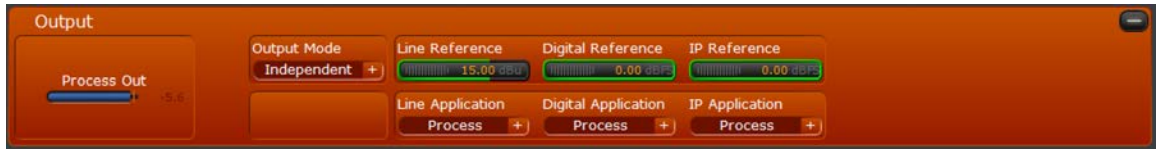

Process Out

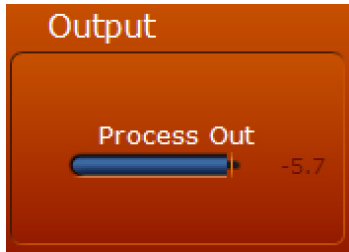

Displays the output level of the processing chain to the selected output (s).

Output Mode

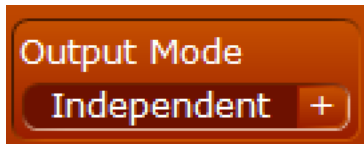

Allows selection of and displays the current output destination for the selected processor channel.

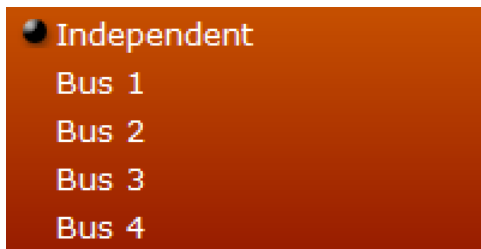

Select between “Independent” or assignment to one of the four internal mix busses.

Independent

Not assigned to a mix bus. The channel will only be routed to the corresponding processor output.

Bus 1-4

Channel will be routed to the corresponding processor output and the selected mix bus.

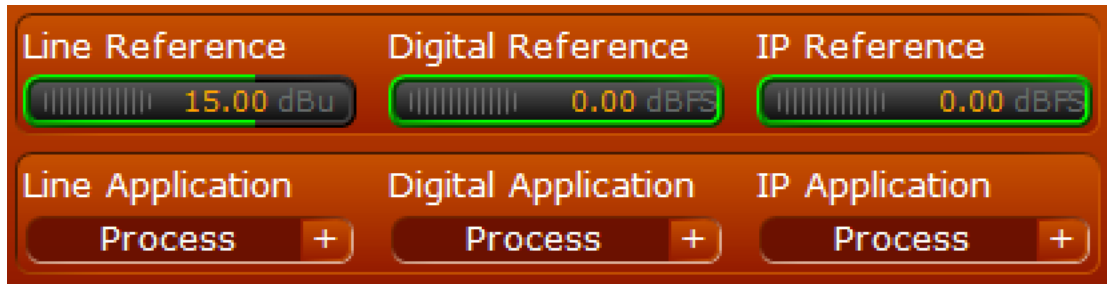
Line/Digital/IP Reference Level and Output Selections**Line/Digital/IP Reference**

Adjusts the reference level of the corresponding outputs relative to the internal digital level.

Line/Digital/IP Application

Chooses the signals applied to each of the selected channel's outputs.



Process

Routes post-processor audio to the output.

Bus 1-4

Routes the selected mix bus to the output.

Input Repl.

Routes the selected *processor input* signal (analog, digital or AoIP) to the output.

Input Repl.

Routes the selected input signal directly to the output.

Mic Repl.

Routes the microphone input directly to the output.

Digital Repl.

Routes the digital input directly to the output. (Note: AES/EBU inputs are “split” stereo pairs. AES input 1 Left will feed output 1, AES input 1 Right will feed output 2, and so on.)

ULA Repl.

Routes the ULA (AoIP) input directly to the output. Routing will be affected by how “ULA L/R Mode” is set. If it is set to “On Both L/R”, the routings will be 1:1 (i.e. ULA input 1 will route directly to analog output 1, ULA input 2 will route directly to analog output 2). If it is set to “Separate L/R” the behavior will be similar to the digital inputs (ULA input 1 left will route to analog output 1, ULA input 1 right will route to analog output 2, and so on).

14 Factory Presets

Overview

The factory presets included with the VOCO 8 provide a good starting point for defining your own custom voice processing signature sound. These presets are designed for male voices (presets beginning with the letter M), female voices (presets beginning with the letter F), or both (presets beginning with M&F), each with varying degrees of processing. The de-esser is bypassed and final 4-Band Parametric EQ in all presets is set flat, though the frequency and “Q” of each EQ band has been customized for each preset. Below is a list of factory presets and a brief description of each. These presets can all be used as the basis for new user presets, but cannot be overwritten or removed. New in version 1.14 are presets for RE-20 and SM7 microphones which should be very good starting points for these popular mics.

Factory Preset List

M&F Open

Designed as a very clean and “open” sound for both male and female voices.

M&F Open Plus

Still very clean and conservative, with just a bit more “punch” than the M&F Open preset.

RE20 Mic Punchy

Designed specifically with the Electrovoice RE-20 microphone in mind, this preset offers plenty of punch and clarity.

SM-7 Mic Punchy

If you have an SM-7, give this preset a try. The response has been tailored specifically to complement the characteristics of this broadcaster favorite.

M&F - Soft tone

A relatively conservative preset designed for both male and female voices. The 3-band processing is set with a slightly higher drive level in the high band (centered at 1.38 kHz) with slightly less in the mid and low band (80 Hz), along with moderate attack and release times. The high and mid processing bands are set to a slightly lower threshold for just a bit more processing action in those bands.

M&F - News Presenter - Soft tone

Similar to the basic “M&F - Soft Tone” preset, “M&F - News Presenter - Soft Tone” has an even more “neutral” quality to it. The low band frequency has been increased to 90 Hz and the drive levels in the multiband processing have been set to “0” with no added or reduced drive in any band. Release times in the multiband processing section are set slightly slower than “M&F - Soft Tone”.

M&F - News Presenter – Natural

This preset is virtually identical to the “M&F - News Presenter - Soft Tone” preset but adds a bit of action in the “Fidelity” section of the multiband processing to give an even more neutral sound than “M&F - News Presenter - Soft Tone”.

M&F - Natural Loud

A fairly neutral yet aggressive preset, “M&F - Natural Loud” focuses a bit more processing effort on the mid and high bands with slightly lower thresholds. Low and high band frequencies are at 250 Hz and 2.6 kHz respectively. The attack times are similar to “M&F - Soft Tone” but the release times have been slowed down, with a slightly faster release and slightly higher output in the high band than the other bands. The mid and low processing bands also get a very slight boost in output level. This preset adds a bit more action in the “Fidelity” section and leans heavily on the final brick wall limiter (6 dB of added drive, “Fast” release) to achieve its loudness.

M&F – Natural

Identical to the “M&F - Natural Loud” preset, with the exception that the brick wall limiter has been returned to 0 dB of additional drive and a “Medium Fast” release time. In addition, the frequency of the “High” band has been changed to 2.11 kHz.

M – Punchy

This is a preset that will definitely stand out from the rest. Leans heavily on the high and mid bands of the processing with lowered thresholds in those bands, while there is much less action in the low band due to a fairly high threshold. The low and high bands are at 90 Hz and 2.26 kHz respectively. All 3 bands have higher drive levels with slightly slower attack times and much faster release times. “Sound Impact System” is enabled in this preset and definitely does give it that extra “punch”. The high and low bands are accentuated with higher output levels from the processing section. This should give a nice healthy low end with excellent vocal clarity.

M - Hot tone

Similar to “M - Punchy”, this preset has an even more aggressive feel to it. The drive to all 3 bands has been increased substantially (set to 8 dB) with faster still release times. The “High” band has been set to 2.11 kHz with the “Low” band at 90 Hz. Output from the multiband section has a nice “scoop” to it with boosts in the high and low bands and a cut in the mid band.

M - Hit tone

This preset is somewhere between “M - Punchy” and “M - Hot Tone” in terms of feel. The “Fidelity” section is enabled here for a very slight pull back of the multiband in the mid and low bands to keep it from getting too muddy or aggressive. “Sound Impact System” is also enabled (as it was in the “M - Punchy” preset) but set for slightly more action than in “M - Punchy”. Drive in all three bands is slightly increased (1.2 dB), with the thresholds set for a bit more activity in mid and high bands. Attack and release in all three bands is fairly fast, with the fastest release in the mid band. The frequencies of the low and high bands have been set to 80 Hz and 1.3 kHz respectively. This preset definitely has a pretty substantial boost in the low end with a 5.8 dB increase in that band set on the output, while the mid band has a slightly smaller increase (1.6 dB) and the high band actually has a very small cut (-0.2 dB). Finally, this preset leans slightly on the final brick wall limiter with an added 1.6 dB of drive for just a bit of extra loudness.

M - Big Voice

A great preset reminiscent of that classic “boss jock” sound. Fairly balanced overall, with a bit of added drive in all 3 bands (1.6 dB) and thresholds set for substantially more action in the high and midrange bands. “Sound Impact System” is enabled in this preset to add that extra little bit of punch. The attack and release times are fairly moderate, and the output from the 3 bands is set to give a nice boost in the high and low end. Low and high frequencies are set to 90 Hz and 2.11 kHz.

F - Structured tone

This is a good starting point for female voices. Low and high band frequencies are set to 80 Hz and 1.3 kHz. The compressor ratio in the multiband section across all 3 bands is slightly less aggressive. Both “Fidelity” and “Sound Impact System” are enabled with quite a bit of activity in the mid and high bands of the Sound Impact System section. The high band has a considerable boost in drive (4.8 dB) with slightly less of a drive increase in the mid and low bands (1.2 dB). The attack time across all three bands is relatively fast but release times have been slowed, with the slowest release in the high and mid bands. The final output from the multiband section has a slight boost in the high band, a 2 dB cut in the mid band, and a 3.4 dB boost on the low band. Finally, the brick wall limiter has an added 1.4 dB of drive to maintain loudness.

F - Hit tone

Similar to “F - Structured tone” with a more aggressive ratio, “Sound Impact System” set for equal activity across all 3 bands, an equal 1.2 dB boost in drive to all 3 bands, and a slightly lower threshold for the high band. This preset also features less of a cut in the mid band (-0.8 dB instead of -2 dB). Attack and release times, as well as the final limiter settings are identical to “F - Structured Tone”. The end result should be a bit more of a high and midrange presence than “F - Structured Tone”, though leaning less on activity in the high band due to the reduced drive.

F - High Mid

True to its name, this preset accentuates the high mid frequencies of the female voice. The low frequency is centered at 200 Hz, with the high frequency at 1.3 kHz. The ratio is fairly aggressive compared to the other presets. “Sound Impact System” is enabled and set equally to 4.4 dB across all 3 bands. The drive across all 3 bands is substantially increased to 7.2 dB with lowered thresholds in the high and mid bands. Attack and release times are both fairly slow, with the exception of a much faster release in the high band, along with a considerable (5.2 dB) boost in that band’s output. In the final brick wall limiter section, the drive has been reduced by 1.4 dB to compensate for the increased high band output from the multiband section and keep things from getting too harsh.

BY-PASS

This setting will bypass all processing on a channel. It is the only available option when a channel is not licensed for processing.

15 Frequently Asked Questions (FAQ)

Q: I'm getting a PSU error on the screen. What does that mean?

A: You probably didn't attach power to both power supply connections on the rear panel. Double-check both AC power sources and connections.

Q: But what if I don't want to connect both power cords?

A: Just do it. What have you got to lose (besides the pesky error message)? It isn't that we think a power supply will fail; it's designed to improve overall reliability in plants with dual power feeds to the racks.

Q: I've cleared the PSU error, but I'm still getting a "Control IP" or "Livewire/AES67 IP" error on the screen.

A: This generally indicates that an interface is set for DHCP and the cable is unplugged. Double-check to ensure the interfaces are connected and that the IP address settings are correct. If you aren't planning to use the "Control IP" or "Livewire/AES67" Ethernet interface, disable DHCP on that interface to clear the error message.

Q: I can't seem to find any controls besides preset selection and IP configuration—Where is everything?

A: Most of the configuration is done through the Remote Gateway software and not from the front panel. You'll need to configure the "Control IP" interface on the VOCO 8 and install the Remote Gateway software on a PC. If you want to disconnect the unit from the network after initial configuration, that's fine too—but it makes life a lot easier if you leave it on the network where a PC running Remote Gateway can control it.

Q: I connected to the unit through Remote Gateway but I'm still not finding any controls. What gives?

A: There are three default login accounts on the VOCO 8; admin, studio, and live. The account that grants access to the majority of the controls is "studio". There is no default password for this account. Admin will only allow basic configuration and rights management, and live essentially gives the same level of access as the front panel.

User Name	Default Password	Function
admin	admin	Administers user rights and global configuration (no audio controls)
studio	<none>	Allows full control over I/O and processing parameters
live	<none>	Similar to front panel controls; Changes sessions and presets, limited control

Q: How do I enable Phantom power on an input?

A: Under the “Studio” account in Remote Gateway, click on the + next to the “Input” section if it is not already expanded. Select “Mic” as the input if necessary. Settings for mic/line mode, pad, gain, and phantom power will appear. A level meter is provided for reference when adjusting preamp gain.

Q: I’m using the AES/EBU output—Why am I only seeing audio on one channel?

A: Since there are 8 inputs and 4 (stereo) AES/EBU outputs, the inputs are mapped to one half of each stereo pair. Inputs 1 and 2 appear on AES/EBU output 1 Left and Right, and so on. If your mixer or router will not split AES/EBU pairs, or you want to use one microphone per AES/EBU output, you will need to use only the even or odd inputs.

Q: Can I mount the VOCO 8 in a studio?

A: In most cases with a properly cooled facility, yes. There is a fan in the unit. If the unit’s internal temperature begins to rise, the fan will increase in speed and may create enough noise to be audible. If this is an issue, mount the unit in an alternate location and use the Remote Gateway software for control.

Q: I’m still lost. Now what?

A: Check our website at www.telosalliance.com for the latest updates and documentation. If you still have questions, give our 24/7 tech support line a call at 216-622-0247 or e-mail support@telosalliance.com. We should be able to get you up and running quickly.

16 Specifications

Mic Inputs

- ◆ 8 Channels, XLR (Neutrik “Combo” connectors) or DB25F
- ◆ +48v Phantom Power, Switchable
- ◆ -20 dB pad, Switchable
- ◆ Source impedance: 150 Ohms
- ◆ Input impedance: 4000 Ohms
- ◆ Level Range: -75 dBu to -20 dBu

Line Inputs

- ◆ 8 Channels, fl” (6.33 mm) TRS (Neutrik “Combo” connectors) or DB25F
- ◆ Adjustable reference level, accommodates -10 dBu and +4 dBu sources

Digital Inputs

- ◆ 4 Stereo (8 mono—2 channels per digital input)
- ◆ Standard: AES/EBU via Tascam style DB25F connector
- ◆ Sample Rate: 32 kHz to 192 kHz
- ◆ Bit Depth: 24 Bit

Digital Sync

- ◆ Will slave to external reference from any AES/EBU input channel, or internal clock.

Digital Outputs

- ◆ 4 Stereo (8 mono—2 channels per digital output)
- ◆ Standard: AES/EBU via Tascam style DB25F connector

Audio over IP (AoIP)

- ◆ 8 (stereo) input and output channels
- ◆ Inputs can be split L/R across 4 AoIP output pairs, or sent in mono to both sides of 8 AoIP output channel pairs
- ◆ Levels adjustable through Remote Gateway Software
- ◆ Interface: 100 Base-T Ethernet
- ◆ Protocol: Livewire+/AES67 (backwards compatible with Ravenna)

GPIO

- ◆ 10 inputs and outputs
- ◆ Dual 15 pin GPIO connectors (AXIA standard)
- ◆ Opto-isolated inputs
- ◆ Solid State Relay outputs
- ◆ Internal power source for logic

Audio Performance

- ◆ Frequency Response: 10 Hz-22 kHz, +/- 0.2 dB
- ◆ Distortion: < 0.2% THD

I/O Latency

- ◆ Processing Delay: Approximately 3 ms (nominal)
- ◆ Analog input: 1.17 ms
- ◆ Analog output: 0.85 ms
- ◆ Livewire I/O: Approximately 2 ms (“Live” stream mode)
- ◆ Digital input: 3.4 ms at 44.1 kHz or 3.2 ms at 48 kHz
- ◆ Digital output: 3.3 ms at 44.1 ms or 3.2 ms at 48 kHz

IP Remote Control

- ◆ Remote Gateway Software
- ◆ Telnet (“Link & Share” protocol allows full IP control of all processing parameters by external systems)

Remote Gateway Software Compatibility

- ◆ Windows XP SP3
- ◆ Windows 7 (32 & 64 bits)
- ◆ Windows 8 (32 & 64 bits)
- ◆ Windows Server 2008 R2
- ◆ Windows Server 2012

17 Live Preset Adjustment

Overview

In past versions of VOCO software, the functions for the various logins (admin, live, studio) have been strictly defined in terms of their functionality. The new “Live Preset Adjustment” feature adds some crossover between the “Live” and “Studio” logins and allows greatly simplified adjustment of preset parameters. This new functionality also allows various levels of security, including whether or not a preset can be adjusted at all from the live login, if it can be saved over the existing preset, or if it must be saved as a new preset after adjustments are made.



Studio Login

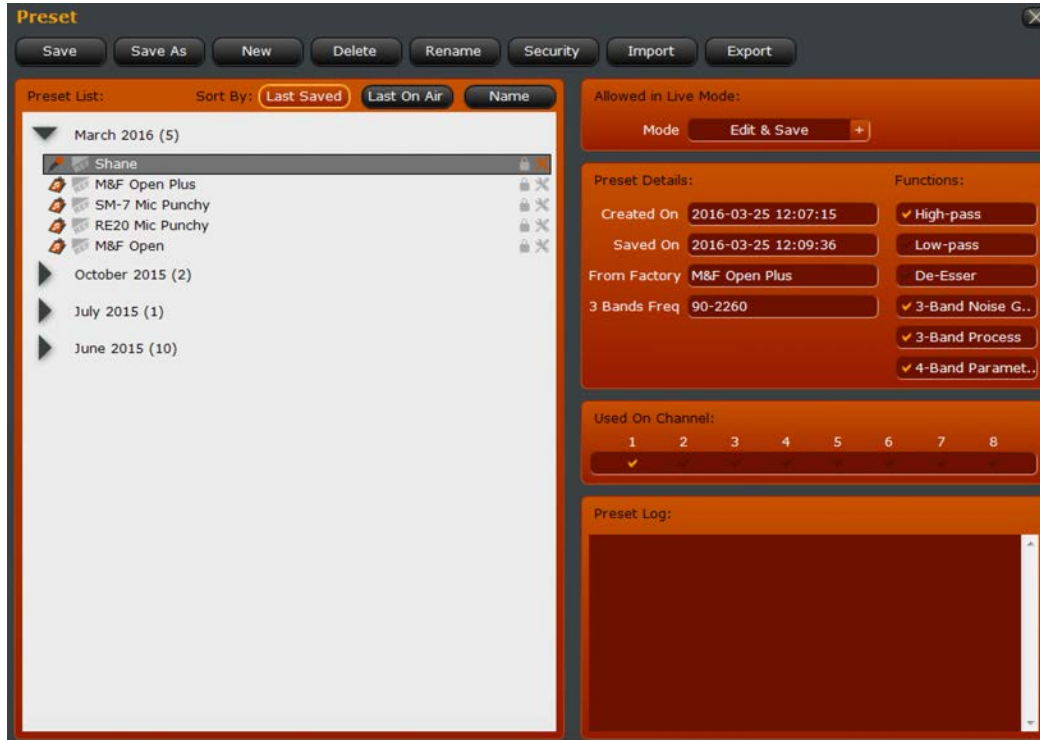

Log into the “Studio” account as usual (Chapter 9).

Enable Live Preset Adjustment



The desired “Live Adjustment” mode for each preset must be selected in the preset management section of the studio login (Chapter 11). The “tool” icon on the right hand side of the list indicates whether or not Live Adjustment is enabled for each preset. An orange icon  indicates that live adjustment is enabled, while a grey  icon indicates that live adjustment is disabled for that preset.

Allowed in Live Mode

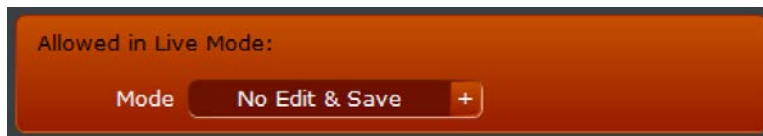

This menu section allows you to enable various live editing modes for each preset. The default setting for this feature is disabled (No Edit & Save).

Mode

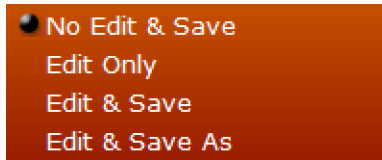

No Edit & Save

The default mode of operation. Editing this preset will not be allowed in the “Live” login.

Edit Only

Editing the preset will be allowed, but changes cannot be saved.

Edit & Save

The preset can be edited, but only saved to the same preset.

Edit & Save As

The preset can be edited and saved as a new preset through the “Live” login.

Live Login

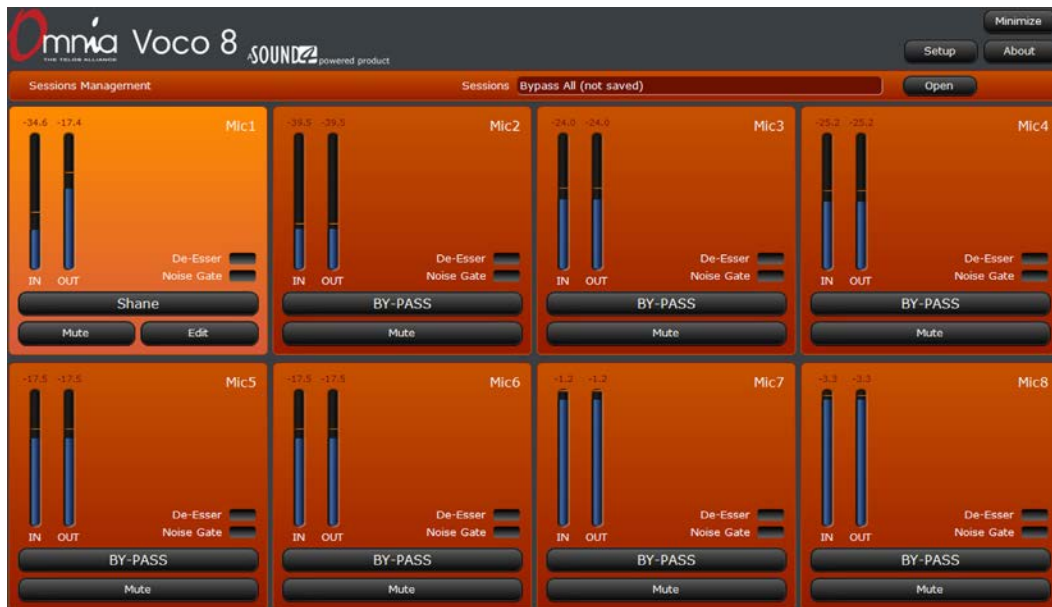

The “Live” login is covered in Chapter 7 of this manual. The interface still works as described in that chapter for the most part.

Edit



For presets that have “Live Editing” enabled, a new “Edit” button appears alongside the channel’s controls. This will open a simplified interface for manipulating preset parameters. The interface is very similar to the “Studio” login, without a number of the setup and audio routing options. This “Edit” button will be present if enabled for a preset regardless of the display configuration (Default, Minimal, Full, or Custom).



Functionality of these controls is as described in Chapter 13 of this manual (Adjusting Processing Parameters). Click the “On/Off” controls to turn a processing section on or off. “Save” and “Save As” may or may not be displayed depending on the configuration of the preset.



A banner across the top of the window displays the action of each processing stage.

Note:

The “Advanced” controls in the “3-Band Noise Gate” and “3-Band Process sections” are not available through this interface.

Preset Selection

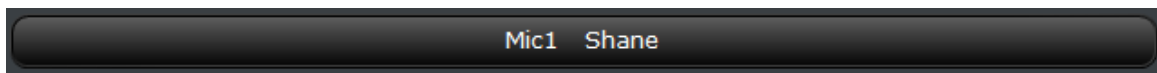

Click the Preset Selection button to load a new preset on the channel. Preset selection is described in Chapter 7.



Note that the Live Edit controls will not be available if they have not been enabled for the preset. Presets with Live Edit enabled will display the  icon.

Bypass

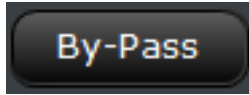

All processing for the selected channel can quickly be bypassed by clicking the “By-Pass” button. This is functionally identical to loading the “By-Pass” preset on a channel, but much quicker.

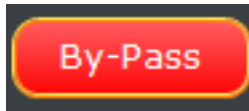

When processing is bypassed on a channel, the bypass indicator will flash red, as well as the preset name in the main window.

Save



If enabled, the “Save” button will save changes to the currently loaded preset.

Save As



If enabled, the “Save As” button saves changes as a new preset.

Close

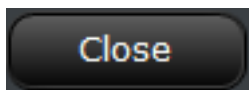

Closes the “Live Edit” window and returns to the main “Live” interface.



1241 Superior Ave. • Cleveland, Ohio, 44114, USA • +1.216.241.7225 • TelosAlliance.com

© 2016 TLS Corp., All Rights Reserved. W16/2/15015