

MAINTENANCE AND OPERATION
INSTRUCTION MANUAL

SOUND4 PULSE

Advanced 3-Band processing
with a 3-Band Limiter
and back-up capabilities

SOUND The logo for SOUND4, featuring the word "SOUND" in black and a red square containing a white stylized number "4".

Contents

Introduction	7
Typographic conventions	8
General Information	9
<i>Technical Specifications</i>	10
Before you start	12
<i>Safety warning</i>	12
<i>Operating recommendations</i>	12
<i>Source Material Quality</i>	12
<i>Unpacking and inspection</i>	13
<i>Radio Frequency Interference</i>	13
Mounting	14
<i>Rack requirements</i>	14
<i>Heat Dissipation</i>	14
<i>Fuse holder</i>	14
Panel Indicators, Switches and Connectors	15
<i>Front Panel</i>	15
<i>Rear Panel</i>	16
<i>Connecting the SOUND4 PULSE</i>	17
<i>The pinout of a DB25 AUX connector</i>	18
<i>The pinout of a DB25 GPIO+RS232 connector</i>	19
<i>GPI Example Connections</i>	20
<i>GPO Example Connections</i>	21
<i>Internal Connections of the GPIO Port</i>	22
Operation	23
Local operation via OLED front panel menu	23
<i>The Basics</i>	23
<i>Menu pages</i>	24
<i>Info</i>	24
<i>Meters</i>	26
<i>Log in</i>	27
<i>Preset</i>	27
<i>Process</i>	28
<i>Setup</i>	29
<i>More</i>	32
<i>Emergency Player</i>	32
WEB Interface	33
<i>IP Address Identification and WEB Interface access</i>	33
<i>Main application window</i>	36
<i>Setup</i>	39
<i>Tools</i>	39
<i>Link & Share</i>	39
<i>Network diagnostics</i>	39
<i>Maintenance</i>	40

<i>Licenses/System</i>	41
<i>Licenses</i>	41
<i>Services</i>	42
<i>Upgrade</i>	42
Software	43
<i>Universal Installer</i>	43
<i>Windows users</i>	43
<i>Linux Ubuntu OS</i>	43
<i>Connection</i>	44
<i>Software</i>	45
<i>Scan interactive button</i>	45
<i>Add Device manually</i>	47
<i>Basic set-up</i>	49
<i>Inputs and Outputs Set-up</i>	49
<i>Inputs Set-up</i>	49
<i>Outputs Set-up</i>	52
<i>Preset selection</i>	55
Operating Guide	56
<i>Title bar content</i>	56
<i>Default</i>	56
<i>Custom 1</i>	56
<i>Custom 2</i>	56
<i>Custom 3</i>	56
<i>Custom 4</i>	57
<i>Customized title bar</i>	57
<i>Input/Output</i>	57
<i>Phys. Input</i>	57
<i>Phys. Output</i>	57
<i>Limiters</i>	58
<i>MPX Power</i>	58
<i>RDS</i>	58
<i>FFT MPX</i>	59
<i>MPX Power</i>	59
<i>Main Processing</i>	60
<i>Meters</i>	60
<i>Monitor</i>	61
<i>Meters and Settings</i>	61
<i>How a parameter can be set</i>	63
<i>Basic and Advanced AGC</i>	64
<i>Basic AGC</i>	64
<i>Advanced AGC</i>	64
<i>Basic and Advanced Tone FX</i>	65
<i>Basic Tone FX</i>	65
<i>Advanced Tone FX</i>	65
<i>Basic and Advanced Stereo FX</i>	66
<i>Basic Stereo FX</i>	66
<i>Advanced Stereo FX</i>	66

<i>Basic and Advanced 3-Band Process</i>	67
<i>Basic 3-Band Process</i>	67
<i>Advanced 3-Band Process</i>	67
<i>Basic and Advanced 3-Band Limiter</i>	68
<i>Basic 3-Band Limiter</i>	68
<i>Advanced 3-Band Limiter</i>	68
<i>Basic and Advanced 4-Band Program EQ</i>	69
<i>Basic 4-Band Program EQ</i>	69
<i>Advanced 4-Band Program EQ</i>	69
<i>Basic and Advanced Final Limiter</i>	70
<i>Basic Final Limiter</i>	70
<i>Advanced Final Limiter</i>	70
<i>I/O Routing & Levels</i>	71
<i>Inputs Set-up</i>	72
<i>Outputs Set-up</i>	73
<i>HD Processing</i>	75
<i>Basic</i>	75
<i>Advanced</i>	75
<i>IP Connect</i>	76
<i>Settings buttons</i>	76
<i>Meters</i>	77
<i>Streaming</i>	78
<i>Emergency Player</i>	80
<i>How a preset can be made</i>	81
<i>Preset Security</i>	82
<i>Preset Export</i>	83
<i>Presets Import</i>	83
<i>Presets Delete</i>	83
<i>Setup</i>	84
<i>Settings</i>	84
<i>General</i>	84
<i>Users</i>	85
<i>Preset Settings</i>	86
<i>Inputs</i>	87
<i>Outputs</i>	88
<i>Stereo Generator & MPX Output</i>	89
<i>Basic RDS Encoder – General settings</i>	90
<i>Basic RDS Encoder – Main PS</i>	91
<i>Basic RDS Encoder – Scrolling PS - Scenarios</i>	91
<i>Basic RDS Encoder – Static and Dynamic Labels</i>	92
<i>Basic RDS Encoder – Dynamic RT</i>	92
<i>Basic RDS Encoder – METADATA</i>	92
<i>Basic RDS Encoder – Advanced</i>	92
<i>Basic RDS Encoder – Meters</i>	93
<i>MPX Power Control (BS-412)</i>	93
<i>Ethernet: AES67/LIVEWIRE+</i>	94
<i>Ethernet: IP CONNECT</i>	95
<i>GPIO</i>	95

<i>Synchro</i>	96
<i>Preset Sharing</i>	97
<i>IP Connect</i>	98
<i>Advanced</i>	99
<i>Upgrade/License</i>	99
<i>Backup/Restore</i>	102
<i>Test Generator</i>	103
<i>Calibrate</i>	104
<i>Hardware/Supervision</i>	105
<i>Maintenance</i>	107
<i>AES67/Livewire+Audio QOS</i>	108
<i>AES67/Livewire+Audio Profiles</i>	109
<i>Livewire+/AES67 Advertisement</i>	110
WARRANTY TERMS AND CONDITIONS	111
Product Registration Card	112

THIS PAGE
IS INTENTIONALLY
LEFT BLANK

Introduction

More than 30 Years of Experience

Delivering the best at all times is not an easy task but the team of SOUND4 makes it seem effortless thanks to over 30 solid years of experience in the field. What we excel at, above everything else, is audio signal processing. Launched back in 2007, SOUND4 began with analog technologies and went on to achieve groundbreaking results in the digital world as well, having an instant impact on the market with a string of innovative products. The launch of a set of FM/HD processing tools was quickly followed by the release of networking audio-over-IP solutions.

2010 was significant in the company's illustrious history as SOUND4's very first multichannel voice processor was introduced on the market and the company integrated the Livewire Audio IP standard, which most of our equipment today is compatible with. This revolutionary product immediately received the acknowledgement of the industry in the form of two prestigious prizes – The 2010 Innovation Trophy in Paris and the Pick Hit Award at the 2012 NAB Show in Las Vegas. Further recognition came in 2012 with the release of our Web Radio product range which received a Cool Stuff Award upon its presentation at NAB 2012.

Today, SOUND4 is a household name in the competitive, fast-developing world of broadcasting technology and enjoys a deserved reputation for proven quality and reliable service.

The SOUND4 – DEVA Partnership

2016 was a landmark year as two of the most respected companies in the industry – SOUND4 and DEVA Broadcast, joined forces, forming a powerhouse team dedicated to delivering broadcasting excellence. Adding to the equation its own expertise and years of experience at the top level, DEVA brings to the table its considerable resources and knowledge of hardware development to ensure unparalleled quality of the finished product.

A Wealth of Engineering Talent

What our merchandise owes its massive appeal to is the creativity of a highly-skilled team of engineers responsible for bringing bright, fresh ideas to life through vast know-how in their respective fields. We pride ourselves on not allowing any compromises with quality and laying great emphasis on fine-tuning each detail, which we believe is the key to the overwhelming success of our products.

What SOUND4 Guarantees

Besides a combination of creativity and technical expertise, SOUND4 also relies heavily on versatility. Products are developed to serve multiple purposes and offer a number of functions for even better performance. The company provides solutions that are cost-effective, reliable, fully upgradable and very compact in terms of design. Another important advantage is heat reduction, as well as the intelligent interconnection with the rest of the chain, especially where music programming is concerned.

Perfect Sound Quality

Perfect clarity of sound is the signature asset of our products and the reason why SOUND4 today stands for unrivalled audio quality. This is a brand that is recognizable all over the world for affordable excellence, dependability and constant innovation.

Reliable Technical Support

As we appreciate the importance of each product's flawless operation, we guarantee dependable technical support by a team of engineers whose job it is to answer all your questions, provide you with detailed information on device features and capabilities, and guide you through using our products to your best advantage. Expert advice is there for you whenever you need it.

Typographic conventions

This manual uses the following typographic conventions:

Style	Used for
NOTE	Important notes and recommendations
Example	Used when example text is cited
“Menu” on page XX.	References
[OK]	Interface Interactive buttons.
<i>Settings</i>	Menu paths are represented as follows: <i>Settings</i> > <i>General</i> > <i>Backup</i>

General Information

SOUND4 PULSE is sound processing technology at its best. No small detail is overlooked in this product which delivers innovation, multifunctionality and dependability in equal measure to produce the consistently loud and clear sound you need. It has a powerful processing chain which includes 2-band input Automatic Gain Control, based on signal strength and no longer on electrical average values. It automatically detects differences in levels to smooth out variations in sound perception. Its structure ensures perfect stability and enhanced vocals combined with a good bass presence.

The SOUND4 PULSE introduces an innovative process - mono and stereo parts of the signal are processed separately to obtain perfect consistency in terms of both sound and level. Therefore, in moving reception, when the FM receiver switches from stereo to mono and back to stereo, the sound variations and changes in level are reduced by over 90%. In the SOUND4 PULSE processing chain, the stereo expander can be used substantially without any limitations.

With the 3-band processor, a single algorithm guarantees the gain in each of the bands in order to complete sound stability. "Coloring" is controlled by the Fidelity parameter, which means that it is possible to have a "purist" and a "colored" sound texture. The 3-band limiter prepares the work of the final limiter and is provided with a very powerful algorithm, simplified to the maximum, so that it is not encumbered with useless parameters.

One of the most significant features of the SOUND4 PULSE is the 4-band parametric equalizer, which is not there to "build a sound" but rather allows some final little touch-up that may be required before the final limiting section.

What is more, this tool has reliable backup capabilities and a number of options. These include Basic and Full RDS, Streaming Extension, IP TX + RX and Dual IP TX + RX to name but a few. It can also perform Internet radio streaming and has six fully configurable encoders supporting MP3, AAC and HE-AAC v1 and v2.

SOUND4 PULSE comes in a convenient, compact 1U case and has a dual power supply, which is a standard feature of all SOUND4 Premium standalone line of products and provides constant, uninterrupted operation of your unit. Combined with an affordable price and the easy-to-use remote control interface, this is the ultimate sound processing tool.

TECHNICAL SPECIFICATIONS

ANALOG INPUT	
Quantity	2 stereo
Level	2 ranges (+12 or +24 dBu - software selectable)
Impedance	10 k Ω
Connectors	1 pair of XLR female balanced, EMI suppressed; 1 pair on a DB25 female (TASCAM pinout) balanced, EMI suppressed
DIGITAL INPUT	
Quantity	2 stereo
Standard	AES3
Sampling Rate	32 to 192kHz, 24 bits
Connectors	1x XLR female balanced , EMI suppressed; 1 on a DB25 female (TASCAM pinout) balanced, EMI suppressed
AES/EBU INPUT SYNC	
Quantity/Connector	1 on a DB25, EMI suppressed
Sync Type	Word Clock - 32 to 192 kHz
Video	PAL or NTSC
Level	1 to 6 Volts
Impedance	75 Ω
SCA/RDS INPUT	
Quantity/Connector	2x BNC, EMI suppressed
Type	Adder
Level	Same as MPX output (adder)
Impedance	75 Ω or 10 k Ω , jumper selectable
ANALOG OUTPUT	
Quantity	2 stereo balanced (with automatic unbalancing)
Level	2 ranges (+12 or + 24 dBu - software selectable)
Load Impedance	10 k Ω typ. (> 300 Ω)
Connectors	1 pair of XLR male balanced, EMI suppressed; 1 pair on a DB25 female (TASCAM pinout) balanced, EMI suppressed
DIGITAL OUTPUT	
Quantity	2 stereo
Standard	AES3
Sampling Rate	32 to 192kHz, 24 bits
Connectors	1x XLR male balanced, EMI suppressed; 1 on a DB25 female (TASCAM pinout) balanced, EMI suppressed
STEREO GENERATOR MPX OUTPUT	
Quantity/Connector	2x independent BNC, EMI suppressed
Signal	MPX or 19kHz pilot
Level	2 ranges (+6 or +18dBu - software selectable)
Load Impedance	75 Ω typ. (> 35 Ω)

AUDIO SPECIFICATIONS	
Processing Delay MPX	30ms
Processing Delay Analog Out (HD)	11ms
Frequency Response MPX	30Hz - 15 kHz +/-0.2dB (de-emphasized)
Frequency Response Analog Out (HD)	30Hz - 20 kHz +/-0.2dB
Signal to Noise	>90 dB
Distortion MPX	<0.018% THD
Distortion Analog	<0.006% THD
Separation	>70 dB
AUDIO OVER IP	
Live Protocol (AES67)	Ethernet 100Mbps; Compatible AES67, Ravenna, Livewire, Dante; 48kHz, 24 bits, stereo, >= 12 samples/packet (250µs), delay 1ms
Transport protocol (IP)	Ethernet 100Mbps; High quality stereo codec (32 to 200kbps) or linear; 2.5s compensation buffer
POWER SUPPLY	
Type	Dual Redundant
Voltage	100 – 260 Volt AC, < 40W
OPERATING CONDITIONS	
Operational between	0 – 50°C
SIZE AND WEIGHT	
Dimensions (WxHxD)	485 x 44 x 260mm
Shipping Weight	540 x 115 x 300 mm / 2.700 kg
POWER UP BOOT	
Boot time	3s
BYPASS RELAY	
AES	AES in => AES out
Analog	Analog in => Analog out
OPTIONAL INTERFACES	
USB	2.0, for upgrades
micro SD card	for music files
RS232	DB25 standard, for RDS (shared with GPIO)
GPS input	For System time and AoIP Sync. SMA connector (active antenna)
GPIO	8 inputs, 8 outputs (opto-isolated) with 5V supply (DB25 male)
SOUND4 REMOTE CONTROL SOFTWARE OPERATING SYSTEMS	
Linux Debian	32 & 64 bits
Microsoft Windows	32 & 64 bits: Windows 7, Windows 8, Windows 10, Windows Server 2008 R2, Windows Server 2012
PC TO CLIENT COMMUNICATION INTERFACE	
TCP/IP	Client (Remote) / Server (Pulse) architecture via Ethernet 1000Mbps
Link & Share	All parameters are accessible via simple Telnet protocol
SNMP	Supervision with Trap Feature

Before you start

SAFETY WARNING

- The servicing of electronic equipment should be performed only by qualified personnel;
- Before removing the covers the SOUND4 PULSE must be switched off and the mains cable unplugged;
- When the equipment is open, the power supply capacitors should be discharged using a suitable resistor;
- Never touch the wires or the electrical circuits;
- Use insulated tools only;
- Never touch the metal semiconductor. They might carry high voltages;
- For removing and installing electronic components, follow the recommendations for handling MOS components

ATTENTION: SOUND4 PULSE has an internal Lithium battery. Do not try to re-charge this battery! Please contact us for detailed instructions in case the battery should be changed.

OPERATING RECOMMENDATIONS

For the normal operation of SOUND4 PULSE, we recommend following the instructions listed below.

- Install the unit in places with good air conditioning. The SOUND4 PULSE is designed to operate within the ambient temperature range of 10 to 50°C. The equipment rack should be ventilated in order for the device to keep its internal temperature below the maximum ambient temperatures;
- We do not recommend installation in rooms with high humidity, dusty places or other aggressive conditions;
- Locate the device away from abnormally high RF fields;
- Use only checked power supply cables. We strongly recommend the usage of shielded cables;
- Connect SOUND4 PULSE only to reliable power supply sources. In case of unstable power supply, please use Uninterruptible Power Supply (UPS);
- Use the device only with its top cover on to avoid electromagnetic anomalies. Otherwise, this may cause problems with the normal functionality of the unit;
- For the normal remote operation of the unit, connect SOUND4 PULSE to a good quality Internet connection;
- For the normal operation of SOUND4 PULSE, check if the network settings pass through all the required data traffic.

SOURCE MATERIAL QUALITY

The SOUND4 PULSE is designed to achieve perfect sound quality, regardless of the source material. Though, it is very important that the source audio to be as clean as possible, as upon processing the poor-quality source material will cause distortion and unpleasant audio defects.

UNPACKING AND INSPECTION

Upon receipt, the equipment should be inspected for possible shipping damages. If such are found or suspected, notify the carrier at once and contact SOUND4 Ltd. The original shipping carton box and packing materials should be kept for possible reuse, in case of return for Warranty repair, for example. Shipping damages as a result of improper packing for return may invalidate the Warranty!

IT IS VERY IMPORTANT that the [“Product Registration Card”](#) included in the Manual be completed accurately and returned. This will assure coverage of the terms of the Warranty and it will provide a means of trace in case of lost or stolen equipment. In addition, the user will automatically receive SERVICE OR MODIFICATION INSTRUCTIONS from SOUND4 Ltd.

The SOUND4 PULSE set includes:

1. SOUND4 PULSE device;
2. Power supply cables x2;
3. Pouch with documents – Declaration of Conformity and Approval Information, Warranty terms and conditions, Product registration card, Waste form.

RADIO FREQUENCY INTERFERENCE

Although we have made provision for SOUND4 PULSE installation in the immediate proximity of broadcast transmitters, please do practice some care using the unit near abnormally high RF fields.

Mounting

RACK REQUIREMENTS

The SOUND4 PULSE mounts in a standard 19-inch equipment rack and requires only 1¾ inches (1U) of vertical rack space. In order the painted finish around the mounting holes to be protected, the use of plastic washers is recommended.

HEAT DISSIPATION

Having very low electricity consumption, the SOUND4 PULSE itself generates negligible heat. The unit is intended for operation within an ambient temperature range, extending from freezing to 120°F/50°C. But because adjacent, less efficient equipment may radiate substantial heat, be sure that the equipment rack is adequately ventilated to keep its internal temperature below the specified maximum ambient.

FUSE HOLDER

The fuse holder is placed inside the unit, next to the voltage selector. Apply downward pressure and pull the cap outward to access the 5mm mains fuse. The reverse process will release the cap.

Panel Indicators, Switches and Connectors

FRONT PANEL

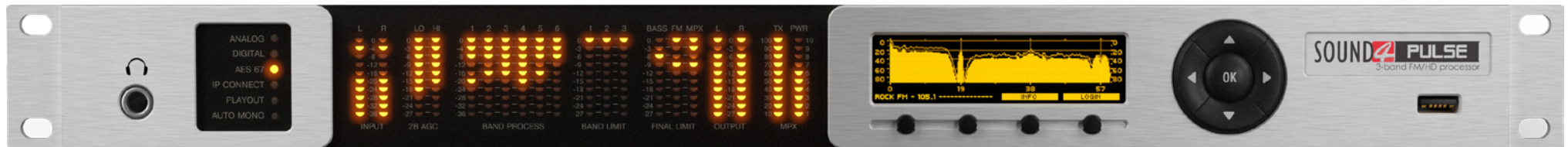

PHONES – Stereo 1/4” (6.3 mm) jack output for headphones.

Status indicators – indicates that the following sources are active - Analog, Digital, AES 67. IP connect, Payout, Auto Mono.

LED Meters – The full-time LED meters allow quick and easy monitoring of the metering, making the setup, adjustment and programming easy.

OLED Display with scales;

Context-Sensitive Soft Buttons

Navigational Buttons

USB Communication Port

REAR PANEL

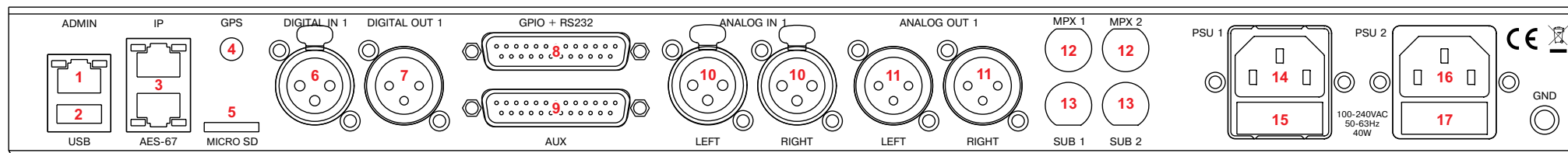

1. Ethernet T-BASE10/100 RJ45;
2. USB communication port;
3. Ethernet T-BASE10/100 RJ45;
4. Consumer-standard SMA connector for GPS Antenna Input;
5. Micro SD card
6. Digital Audio Input (XLR)
7. Digital Audio Output (XLR)
8. GPIO + RS232
9. AUX – Auxiliary Audio Inputs and Outputs
10. Analog Audio Input 1 - Left and Right (XLR)
11. Analog Audio Output 1 - Left and Right (XLR)
12. MPX 1 and MPX 2 (BNC) Outputs
13. SUB 1 and SUB 2 (BNC)
14. Mains connector 1, 110-240VAC, IEC-320 C14 type;
15. Fuse holder;
16. Mains connector 2, 110-240VAC, IEC-320 C14 type;
17. Fuse holder;

CONNECTING THE SOUND4 PULSE

For the initial set-up of the device you will only need to connect:

1. One of the power cables to PSU 1 socket;
2. SOUND4 PULSE to the TCP/IP network using a direct network cable, connected to the **ADMIN** port of the device **NOT to the IP ports**.

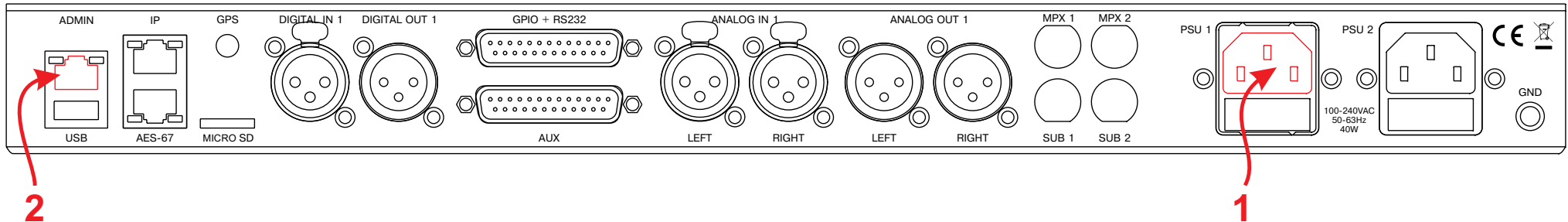

3. Connect all the additional cables to the device in order for it to be properly integrated into your existing network.

THE PINOUT OF A DB25 AUX CONNECTOR

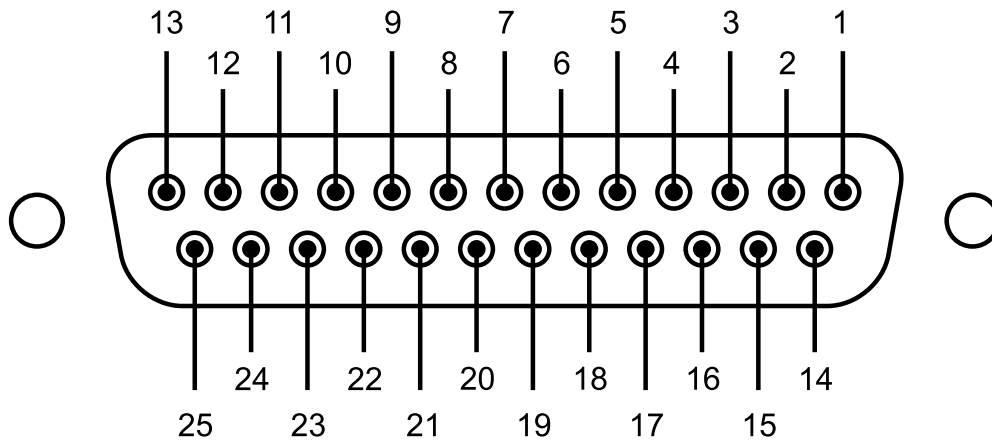

DB25 Female, Compatible TASCAM

Pin	Function
1	Digital Audio Output 2_P
2	GND
3	Not Used
4	Analog Audio Output 2 Right_P
5	GND
6	Analog Audio Output 2 Left_N
7	Digital Audio Input 2_P
8	GND
9	Not Used
10	Analog Audio Input 2 Right_P
11	GND
12	Analog Audio Input 2 Left_N
13	Not Used
14	Digital Audio Output 2_N
15	Not Used
16	GND
17	Analog Audio Output 2 Right_N
18	Analog Audio Output 2 Left_P
19	GND
20	Digital Audio Input 2_N
21	SYNC_IN
22	GND
23	Analog Audio Input 2 Right_N
24	Analog Audio Input 2 Left_P
25	GND

THE PINOUT OF A DB25 GPIO+RS232 CONNECTOR

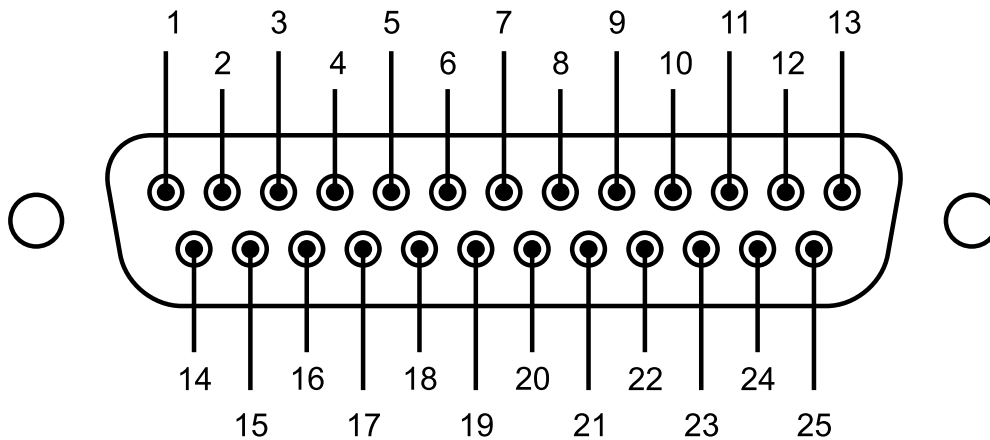

DB25 Male, Compatible V.24 / RS232 (DTE)

Pin	Function	Direction
1	GND	Ground
2	RS_TXD	Out
3	RS_RXD	In
4	RS_RTS	Out
5	RS_CTS	In
6	GPI8	Opto isolated Input
7	GND	Ground
8	GPI6	Opto isolated Input
9	GPI5	Opto isolated Input
10	GPI4	Opto isolated Input
11	GPI3	Opto isolated Input
12	GPI2	Opto isolated Input
13	GPI1	Opto isolated Input
14	GPOCOM	Common GPO rail
15	GPO1	Solid State Relay
16	GPO2	Solid State Relay
17	GPO3	Solid State Relay
18	GPO4	Solid State Relay
19	GPO5	Solid State Relay
20	GPO6	Solid State Relay
21	GPO7	Solid State Relay
22	GPI7	Opto isolated Input
23	GPO8	Solid State Relay
24	GPICOM	Common GPI High-side rail
25	GP5V	+5V (Out), Fuse protected (100mA)

GPI EXAMPLE CONNECTIONS

To activate one Input, GPI pin would be pulled to ground, with a voltage applied on the GPICOM pin (Common to all GPI).

Using external power supply is the recommended method in order to avoid possible ground loops between equipment, as shown in Figure 1-1. The maximum allowed external power supply for logic control is 48 volts DC.

NOTE the presence of Current Limiting Resistors per GPI pin. The intention is to limit the current to 20mA for each GPI pin. Use the table below to choose the suitable Resistor's value.

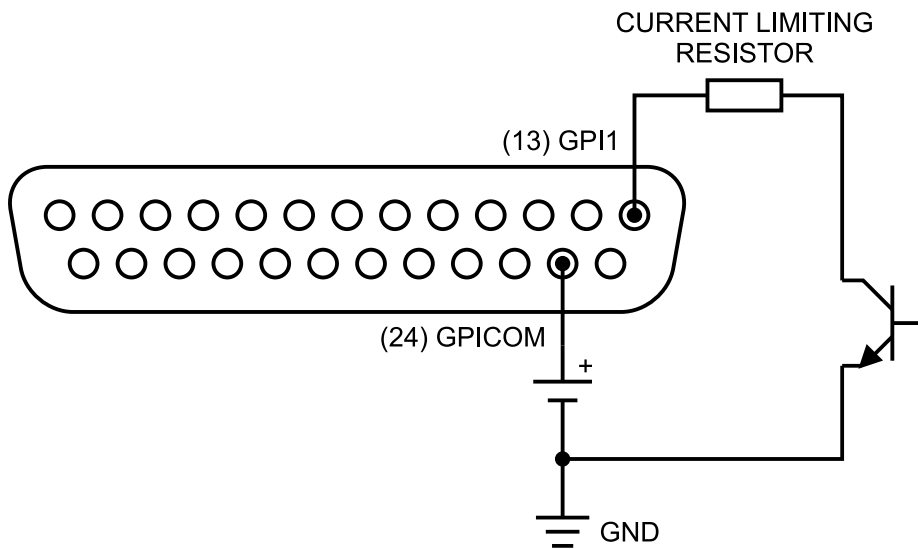

Figure 1-1 - External Power Supply

If the equipment being controlled is electrically isolated, then the use of the GPIO port's power supply is acceptable. The easiest way is shown on Figure 1-2.

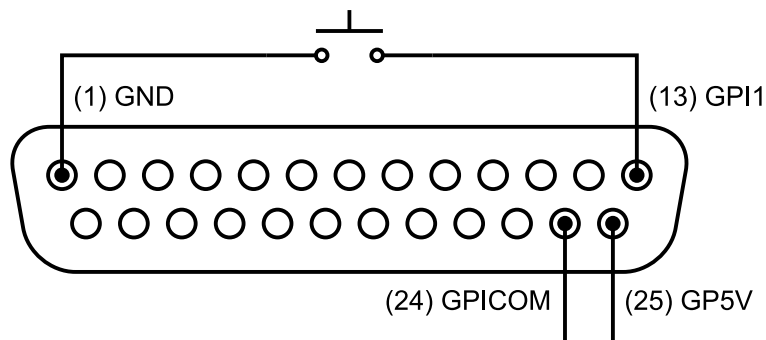

Figure 1-2 - GPIO Port's Power Supply

CAUTION: The use of current limiting resistor per GPI pin is required for some voltages, see table (each input has an internal 330ohms protection).

NOT PROTECTING THE GPI COULD DAMAGE YOUR DEVICE.

VDC	External Resistor
5	0
6	0
12	680 / 0.25Watt
24	1.8k / 0.5Watt
48	3.9k / 1Watt

GPO EXAMPLE CONNECTIONS

The GPO portion of the GPIO port are Solid State Relays. Current should be limited to 100 mA per GPO pin of a port. Maximum allowed voltage is 48 volts. The following diagram shows the recommended connections for outputs with the use of an external power supply.

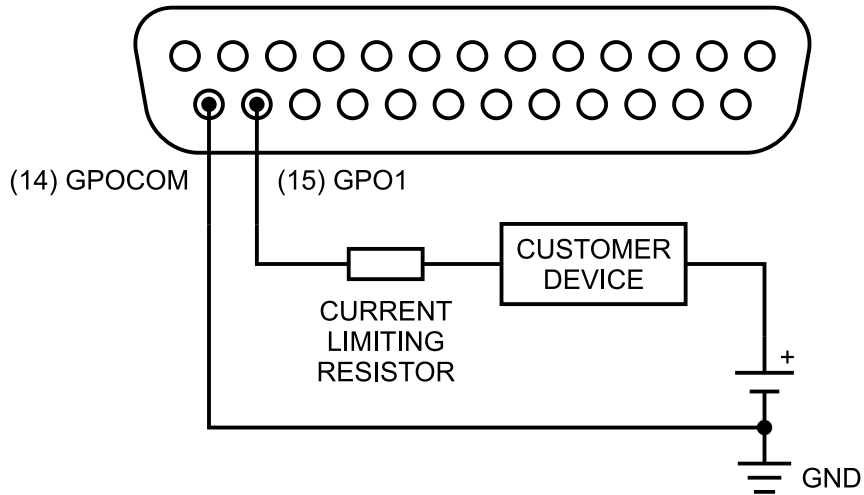

Figure 2-1 - External Power Supply

If necessary, a Current Limiting Resistors must be used to limit the current to 100mA for each GPO pin.

NOT PROTECTING THE GPO COULD DAMAGE YOUR DEVICE.

If the device being controlled is electrically isolated, than the internal GP5V supply can be used, maintaining a 100mA limit on current drawn.

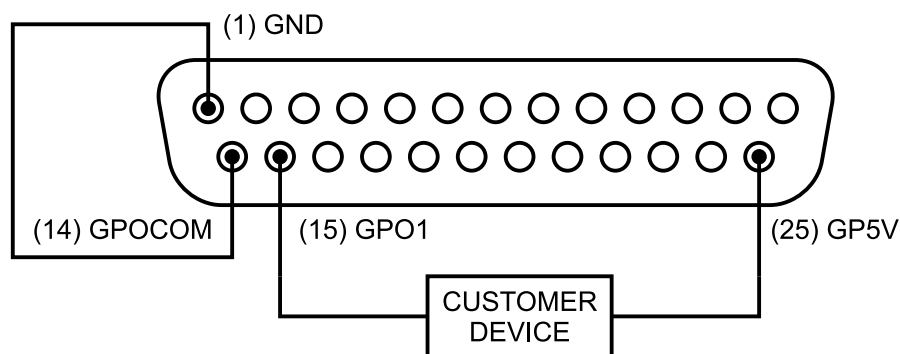

Figure 2-2 - GPIO Port's Power Supply

NOTE: GPO pins and GPOCOM are not polarized, current can flow both directions.

INTERNAL CONNECTIONS OF THE GPIO PORT

GPIO port provides 8 GPI (opto isolated inputs) and 8 GPO (solid state relays). Port is capable of driving a combined current of 100mA. Each GPI pin should be limited to 20mA of current.

Figure 3 shows a simplified diagram of the internal wiring behind the connector. The EMI Filters' parts are omitted for the sake of simplicity.

All of the inputs and all of the outputs on the GPIO port are grouped together. The 8 GPO outputs are on 8 separate output pins, but they share the same "Common Return" connection GPOCOM on pin 14. Similarly, the 8 GPI input pins share one high-side rail GPICOM, connected to pin 24.

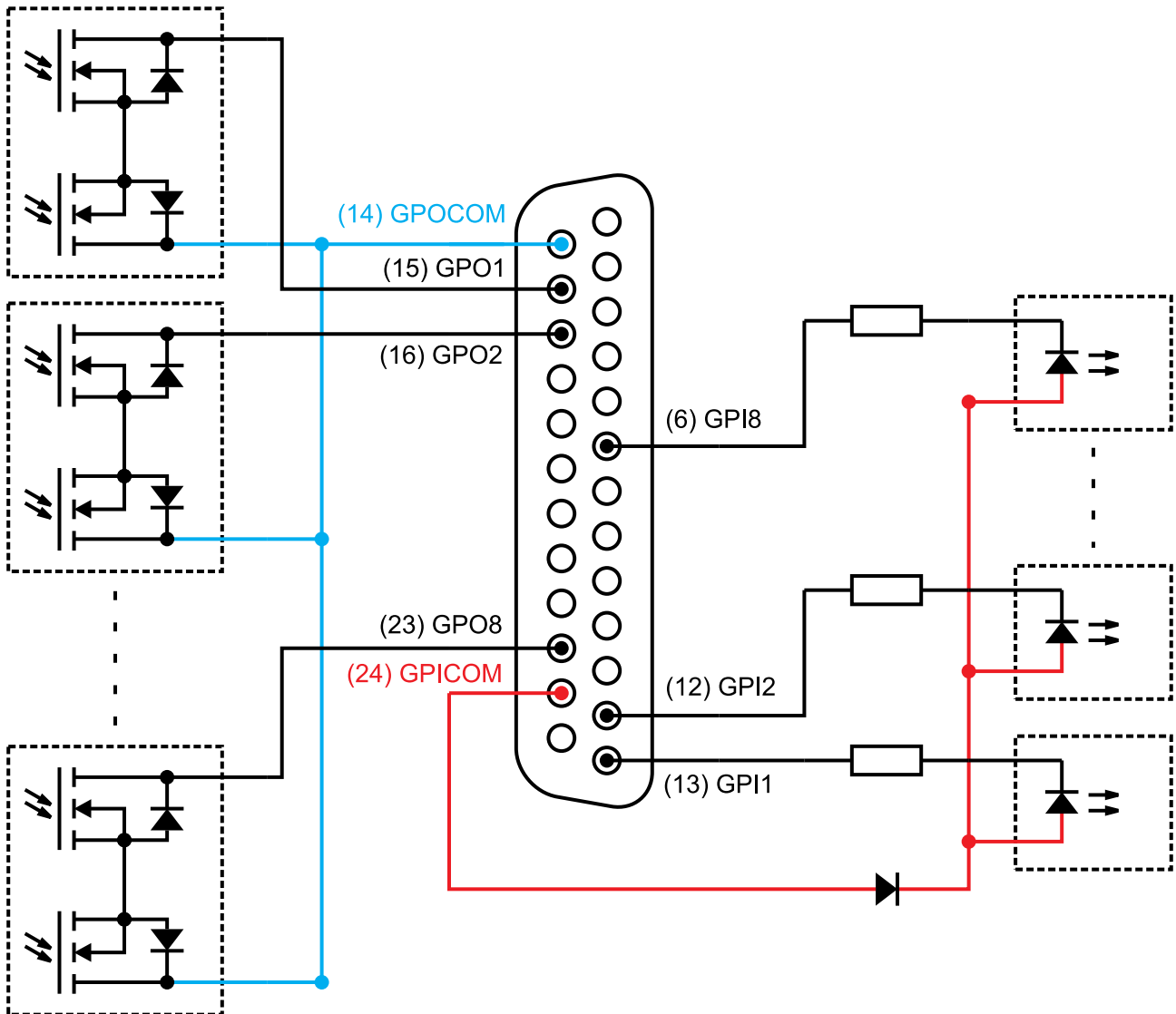

Figure 3

Operation

The SOUND4 PULSE can be operated via the front panel menu, Software and WEB Interface. The WEB Interface of the device provides limited options but is of great use for monitoring purposes or when fast switch of the preset should be made, and the user does not have access to the Software. The WEB interface also allows you to update the firmware of your device quick and effortlessly.

Local operation via OLED front panel menu

You can use the front panel knobs and buttons to set operating modes and make adjustments.

THE BASICS

Upon power-up, the OLED Screen shows the Company Logo and model of the device. After the Initial screen disappears (in a few seconds), it will be replaced by the Main Menu readings. This is the starting point of the navigation process.

Prior to proceeding further in the menu structure, it is important to note the basic functionality - the keyboard (placed on the right of the OLED Screen) consists of [Up], [Down], [Left], [Right] and [OK] buttons. The Main Menu structure has an up-and-down basis, expanded with left-to-right branches.

MENU PAGES

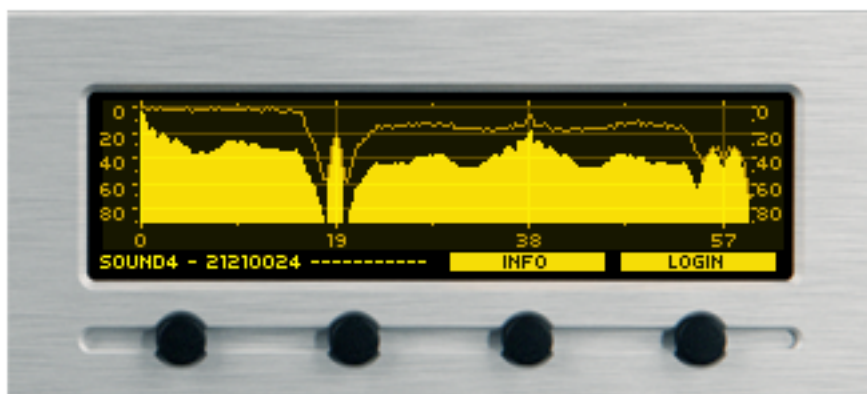

This is how the main window will look like once the device is powered up.

Info

The basic/general information on the device is found here. For example:



Section General - product name, version, serial number and preset in use.

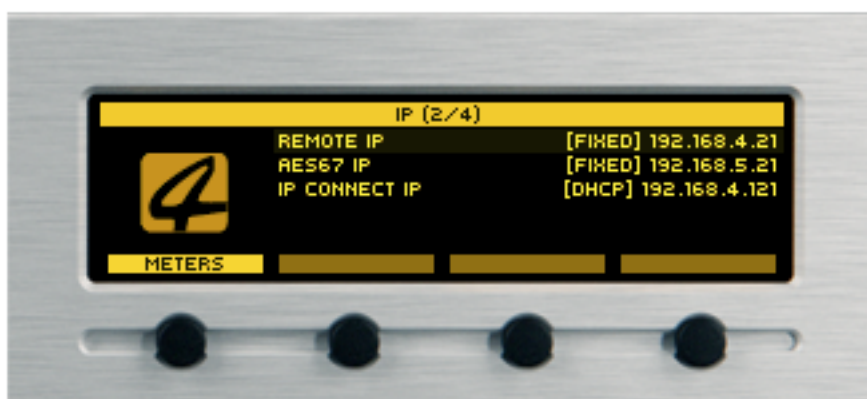

Section IP - contains information as regards the Remote IP, AES67 IP and IP connect IP.

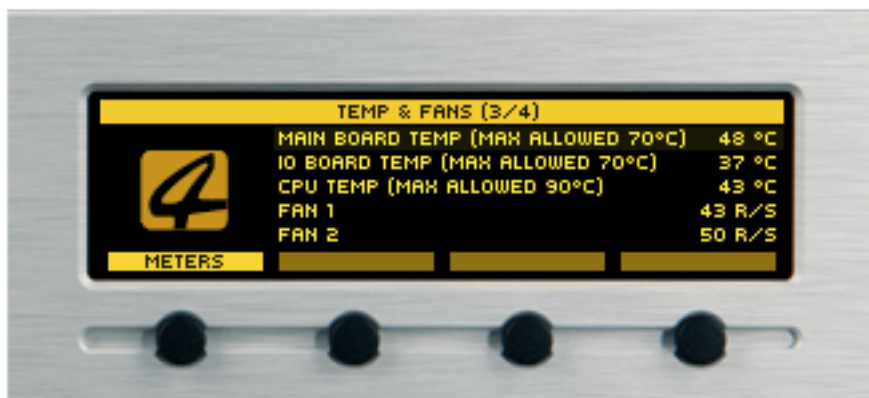

Section Temperature & Fans - contains information on the Main Board Temperature, IO Board Temperature, CPU temperature, Fan 1 and Fan 2.

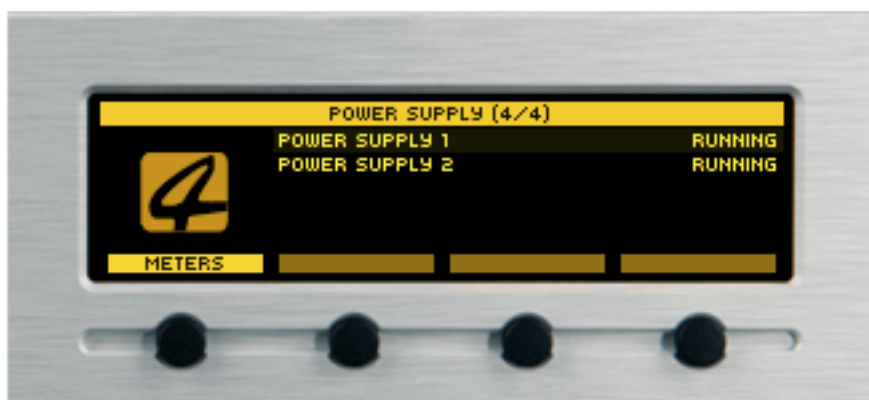

Section Power Supply - contains information as regards the Power Supply 1 & 2 state.

Meters

All the important meters/indicators are available in this section of the menu. When on Main page, the meters can also be switched using the [Up] and [Down] buttons.

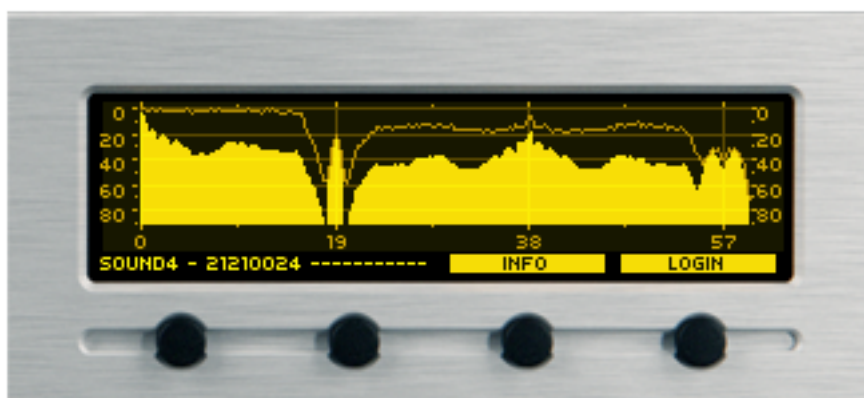
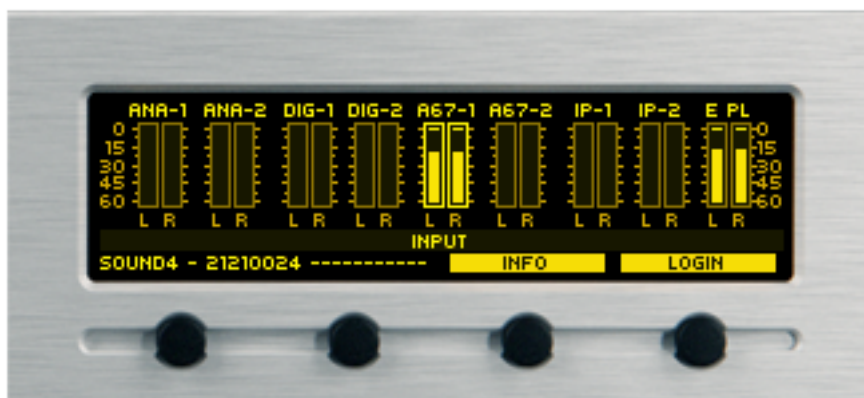
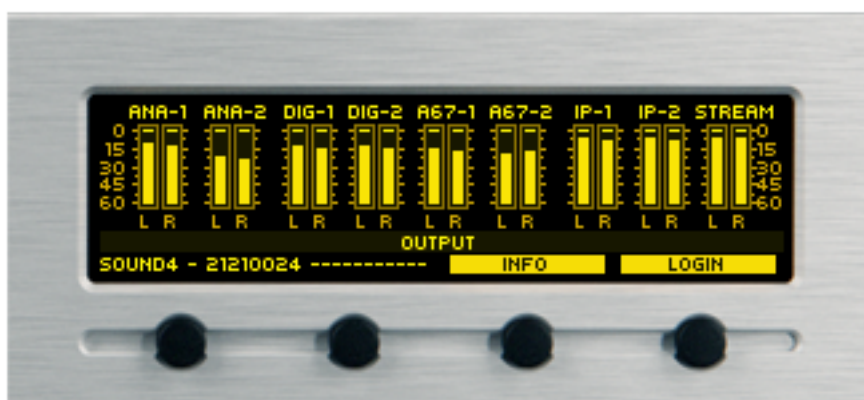
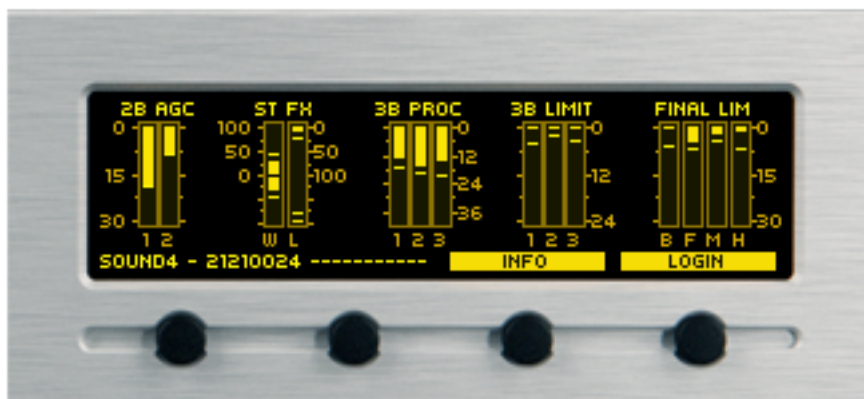

Log in

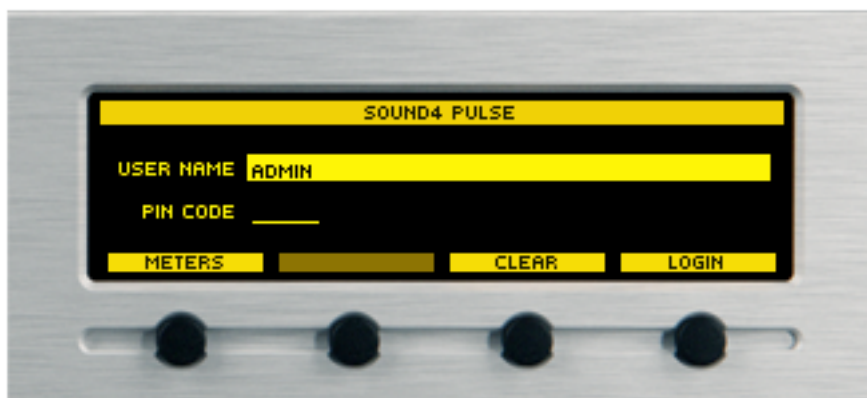

The SOUND4 PULSE requires username and password to be entered in order for the device to be accessed via the front panel. If used for the first time, please note that the SOUND4 PULSE is not protected with PIN code. To enter the device, just press [LOGIN].

If you have set a password, enter the digits using the [Up] and [Down] buttons to change the symbols, and [Left] and [Right] to change the position.

Preset

Lists all the available presets.

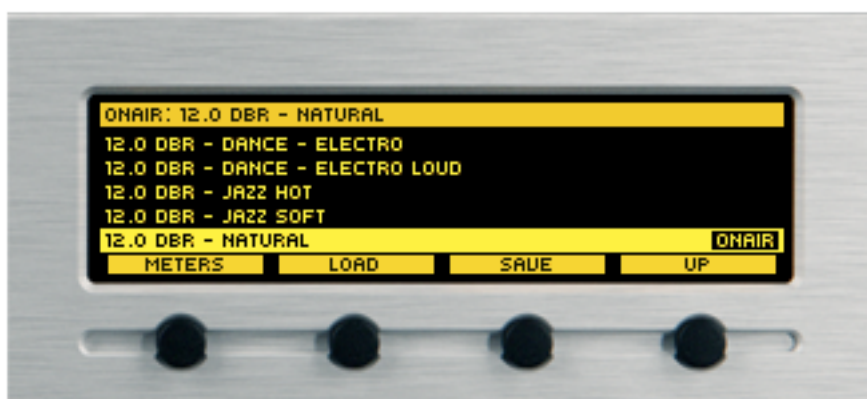

Process

Gathers all the processing parameters, hence allowing changes to the current values to be made.

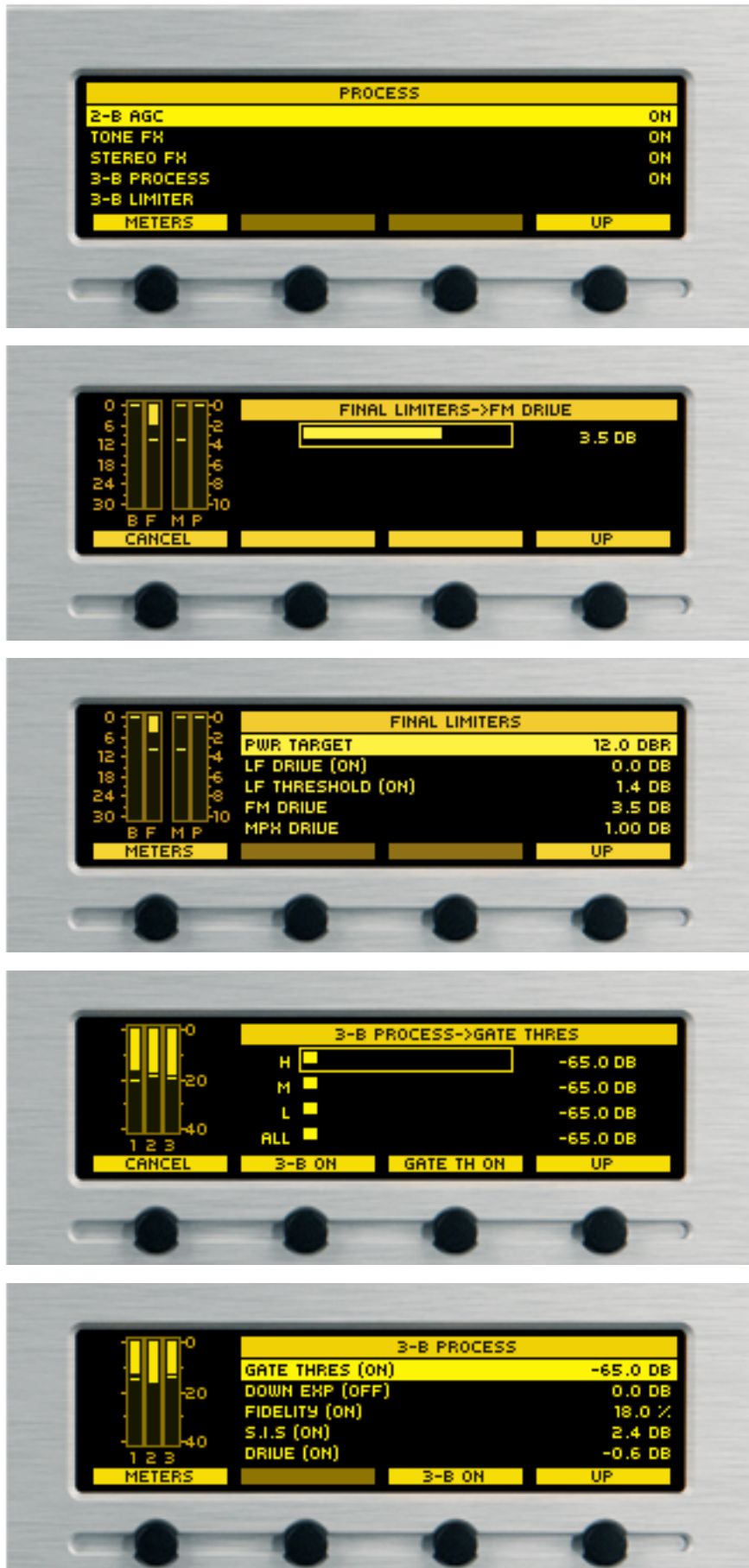

Setup

The Setup menu is organized into a hierarchical tree menu and all similar parameters are grouped into sections (branches).

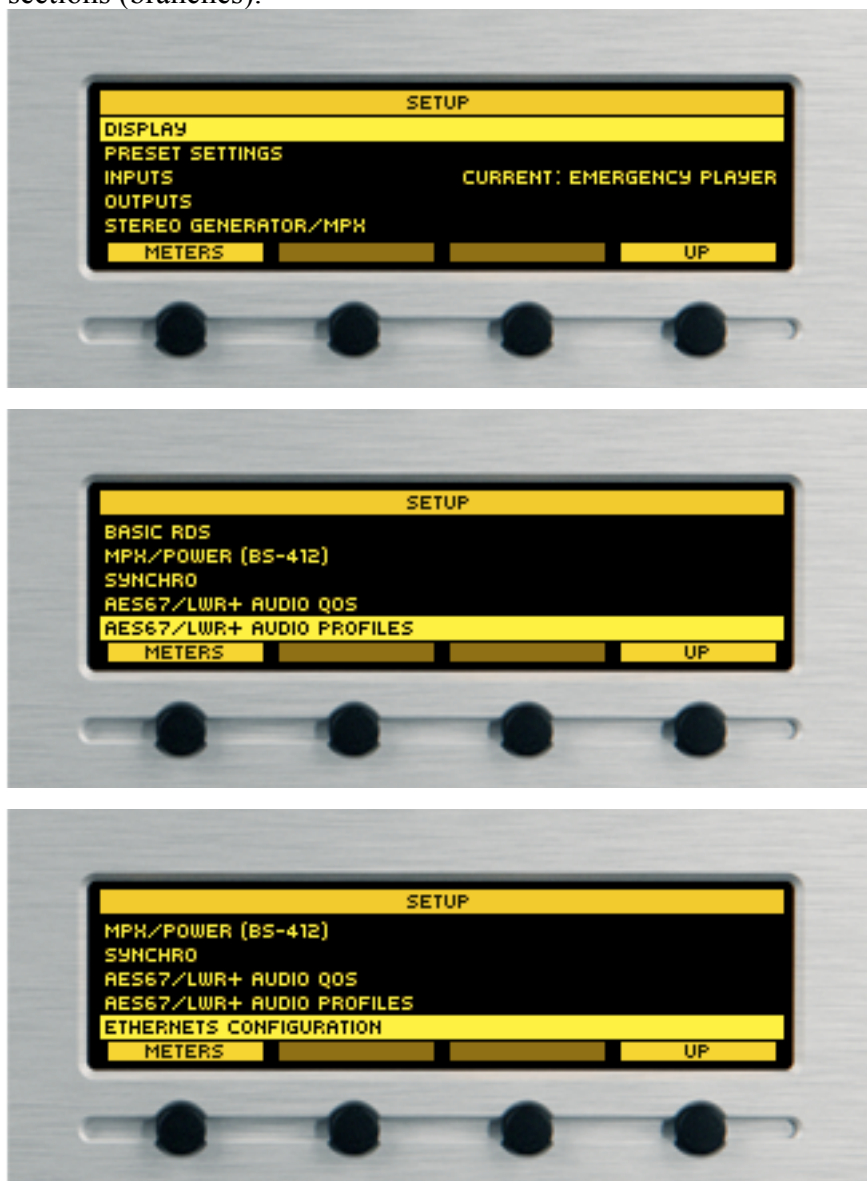

The Setup menu contains the following submenus:

- Display
- Preset settings
- Inputs
- Outputs
- Stereo Generator MPX
- Basic RDS
- MPX/Power (BS-412)
- Syncro
- AES67/LWR+Audio QOS
- AES67/LWR+Audio Profiles
- Ethernets configuration

Each menu allows you to apply the needed settings to the Device. To enter the menu, just press [OK] once the desired menu is illuminated.

Example for similar parameters grouped into sections (branches).



Display



Outputs > Livewire 1

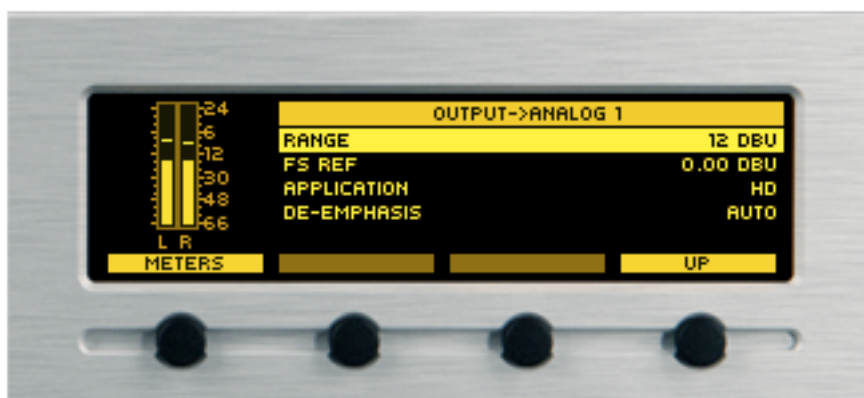

Output > Analog 1



Inputs > Main/Backup

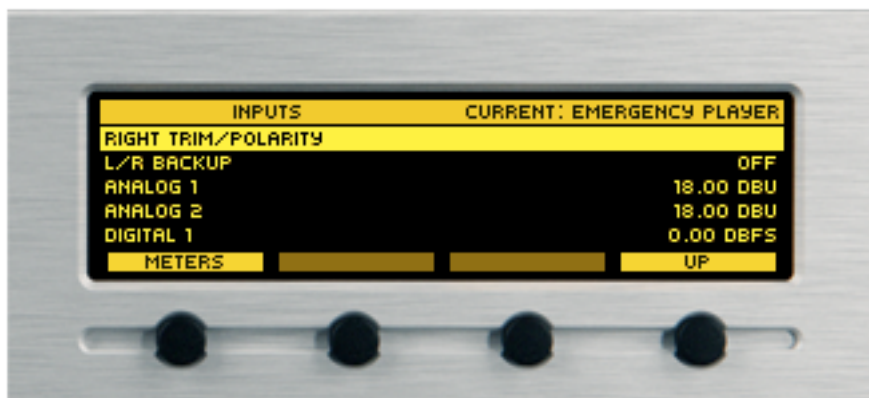

Inputs > Current



Ethernets configuration

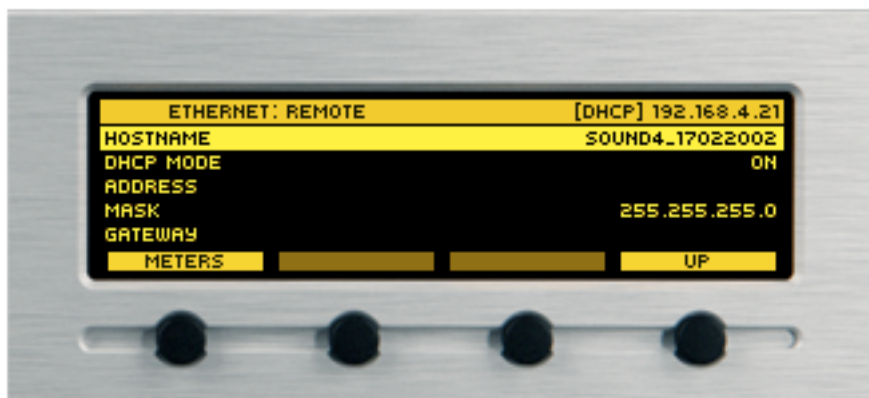

Ethernet: Remote

More

Provides you with quick access to the following parameters:

- Presets
- Process
- IP connect
- Streaming
- Emergency Player
- Setup



Emergency Player

All the needed information as regards the Emergency Player is found here:

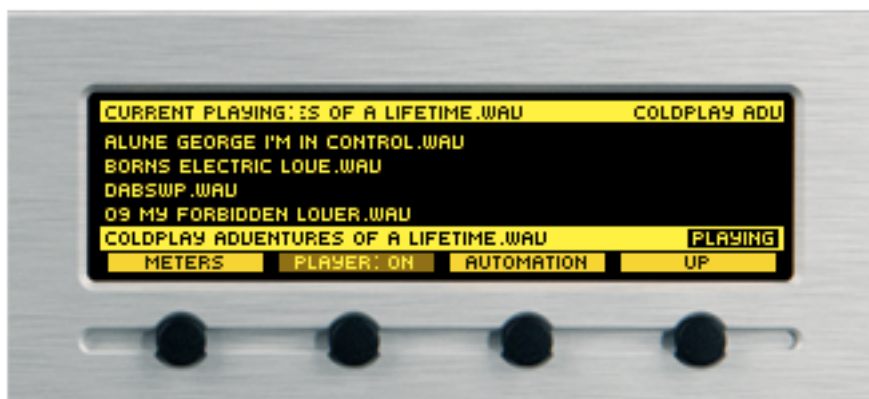

Using the navigational menu you can also make the necessary adjustments of the Emergency Player.

WEB Interface

IP ADDRESS IDENTIFICATION AND WEB INTERFACE ACCESS

Once the device is connected to a local network or to the Internet by the applied LAN cable, through the front panel navigational menu press the soft button labeled [Info] (Picture 1), then using the [Up] and [Down] buttons navigate to IP (2/4) (Picture 2).

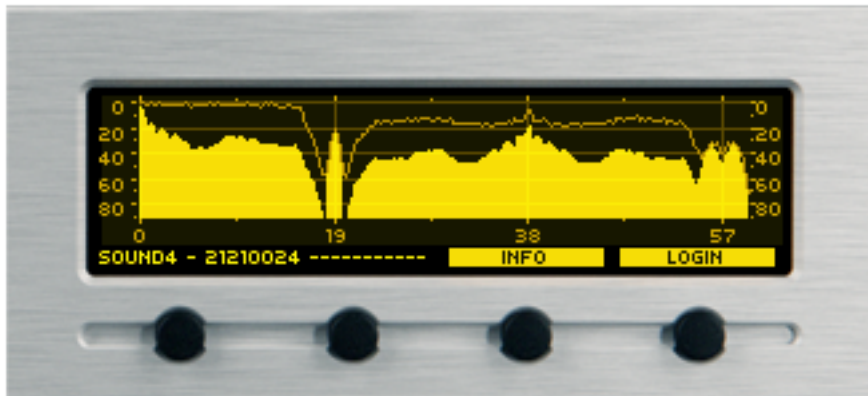

Picture 1

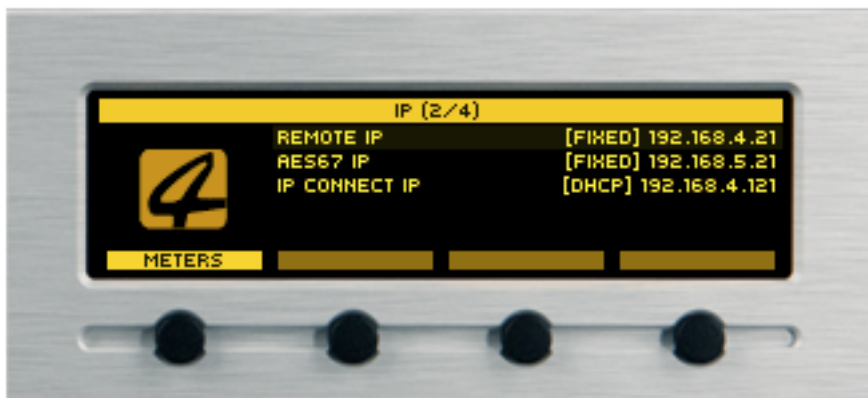

Picture 2

Open a WEB browser of choice and enter the IP address of the device. Please note that **https://** must be entered prior to the IP address of the device, otherwise you will not be able to establish a connection. For example (as depicted below) **https://192.168.20.203**.

Once the IP address is correctly written, press Enter on your keyboard. If the following message appears, please complete the steps listed below:

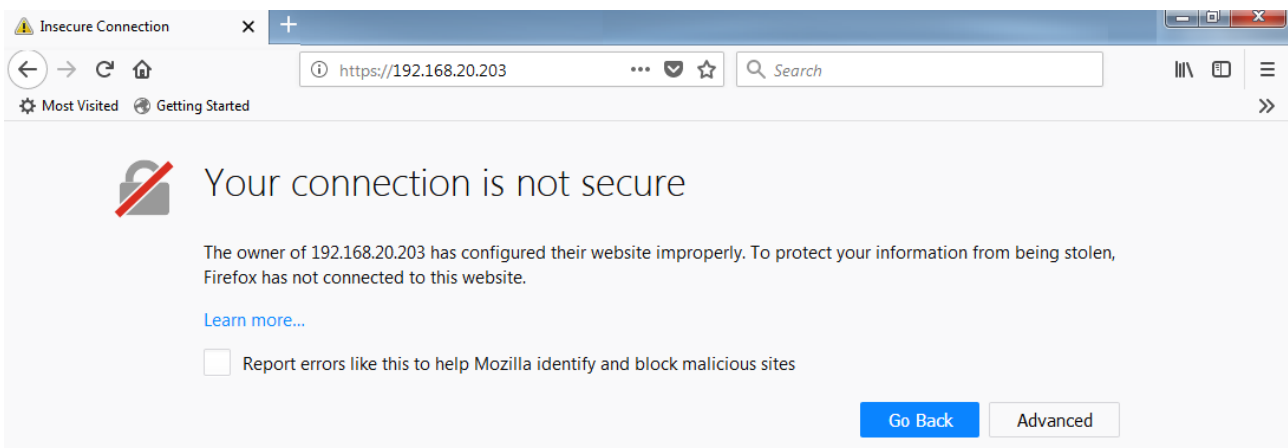

To open SOUND4 PULSE's WEB interface you have to add the connection as secure. To do that, follow the steps listed below:

1. Press [Advanced];
2. Once the below message appears, press on [Add Exception];

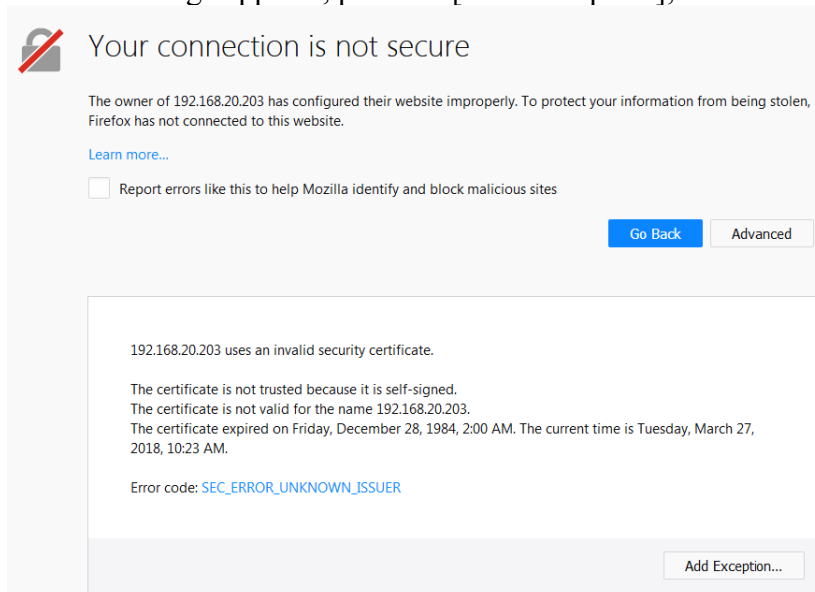

3. An Add Security Exception window will appear. Press [Confirm Security Exception].

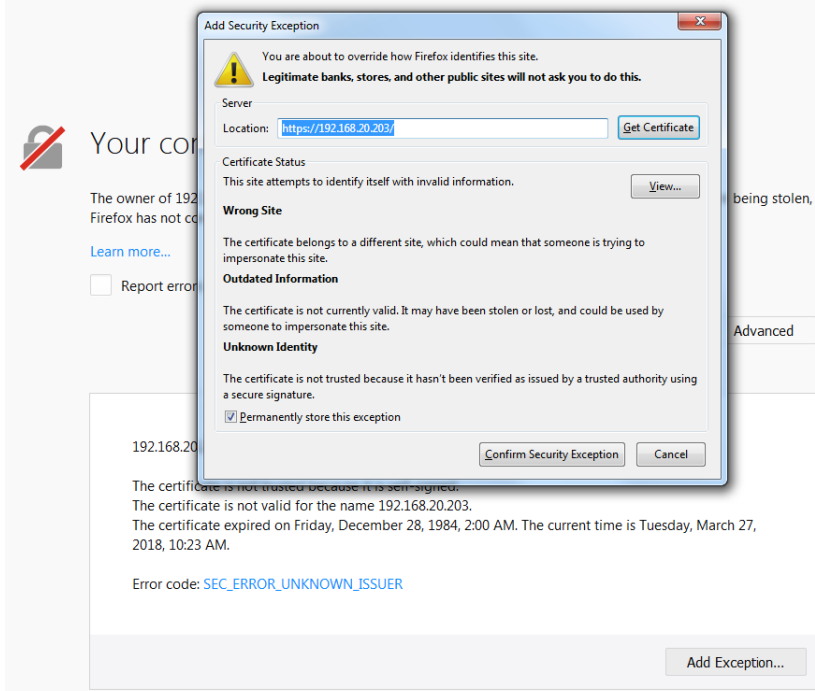

4. Once the process is completed, SOUND4 PULSE's WEB interface will be opened.

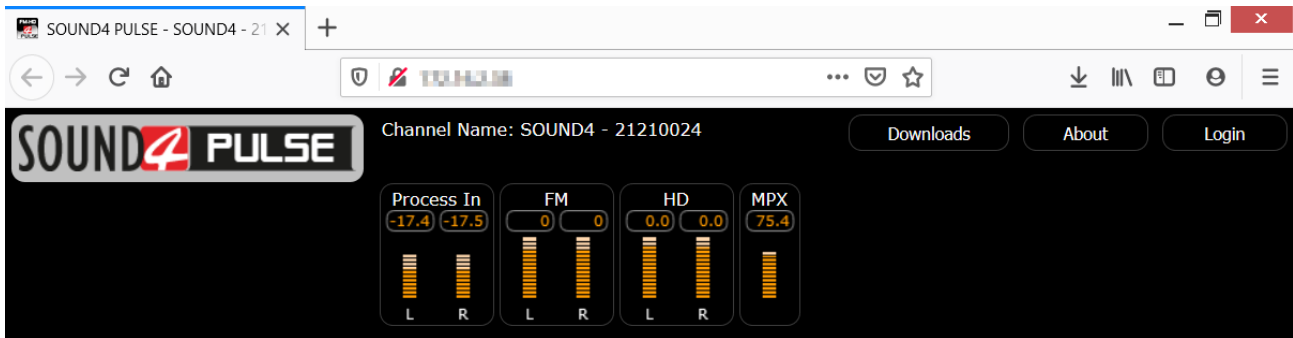

5. To Login, press [Login] and enter the user credentials requested. The default values are:
 - User Name - *admin*;
 - Password - *admin*.

This will open the Main application window.

6. By pressing [Downloads] button, a current Remote software package for windows would be downloaded to your PC.

MAIN APPLICATION WINDOW

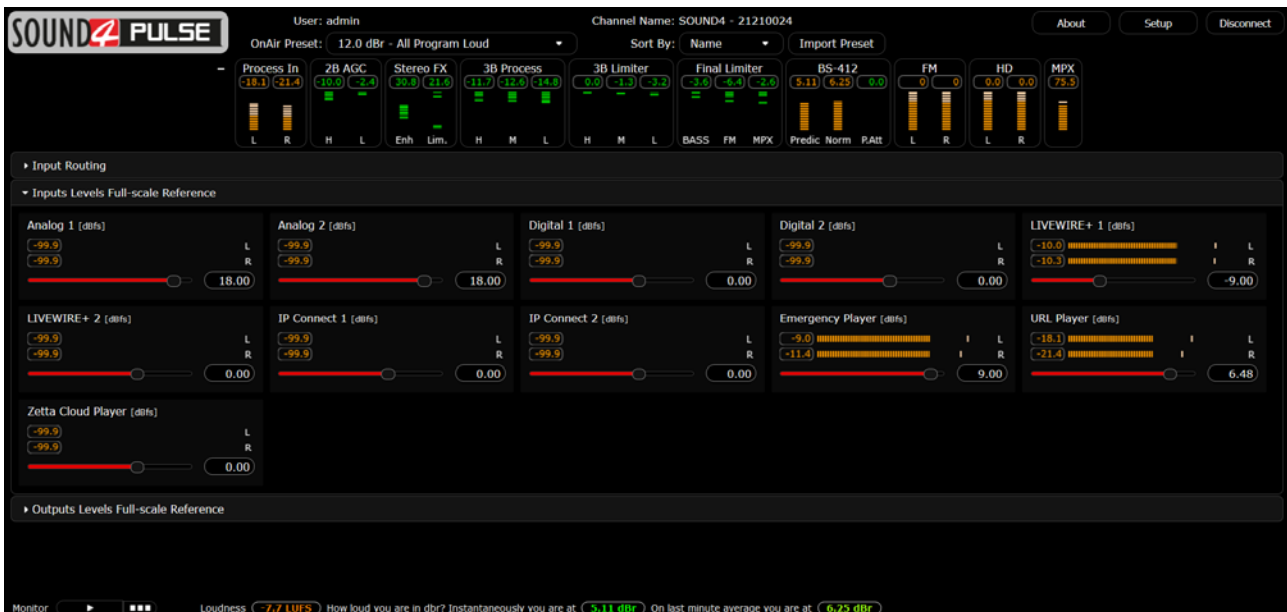

Contains all the basic settings and mandatory information as regards the work of the device. From here you can set:

- Input Routing



Allows source priority of the Analog and Digital Inputs, Liwevire, IP Connect and Emergency player to be set.

- Input Levels Full-Scale reference

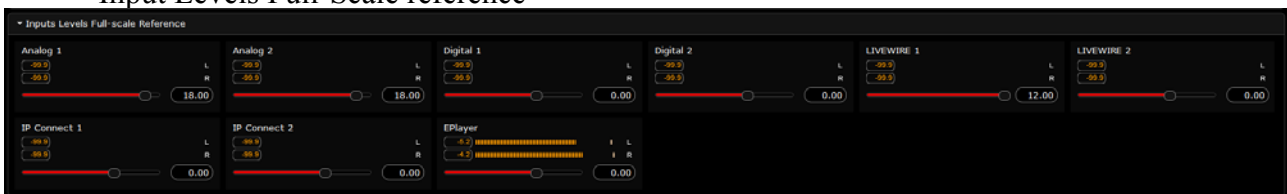

Level settings to the Left and Right Audio Channels of the Analog and Digital Inputs, Liwevire, IP Connect and Emergency player (EPlayer) are applied through this menu.

-Monitor

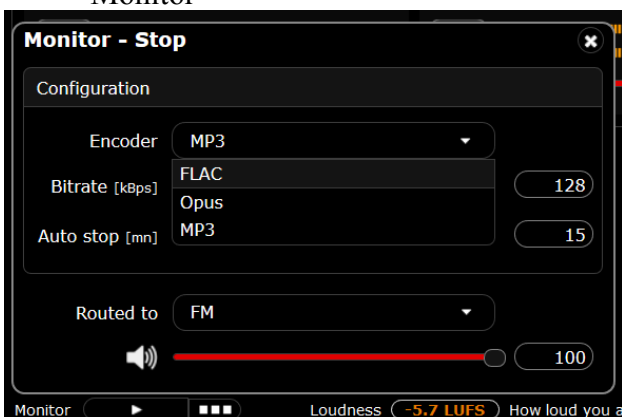

On clicking the Monitor, a window would open allowing to define parameters to stream and listen remotely to the audio from the Processor to your web browser.

Here is possible to set compression type and bitrate according the bandwidth, and a Routing point to monitor inputs, outputs and various stages of processing chain of the unit.

Please note, that only one listener allowed to connect to WebMon in time, so make sure it is not occupied by other users

- Outputs Levels Full-Scale reference



Level settings to the Left and Right Audio Channels of the Analog and Digital Outputs, Liwevire, IP Connect and Stream are applied trough this menu.

- MPX Outputs

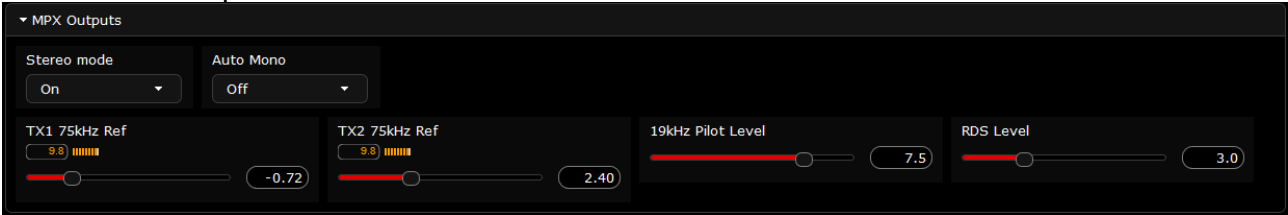

You can turn [On] or [Off] the Stereo mode and Auto Mono. This section also allows you to set the TX1 and TX2 Ref levels, as well as the 19 kHz Pilot and RDS levels.

The [Load preset] button allows you to upload a new preset.

OnAir Preset menu contains information as regards the preset in use. With a click on the button a list with all available presets will be opened. To load a new preset just press on the one desired, and it will be automatically uploaded.

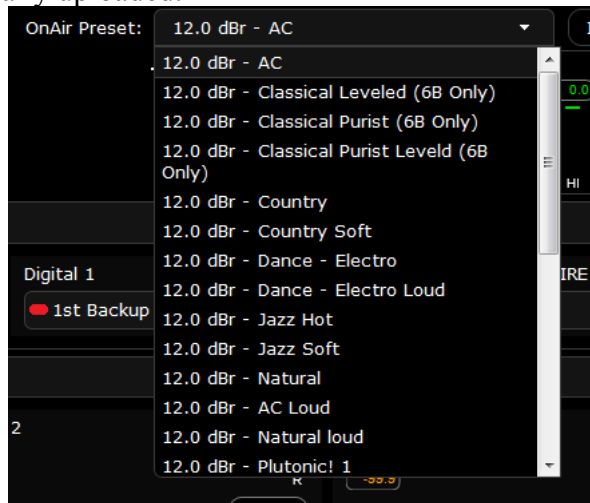

Pressing [About] will open a window containing all the needed information as regards the device's current status:

- Firmware version;
- Serial number;
- Main Board Temperature;
- IO Board Temperature;
- CPU Temperature;
- Fan speed 1;
- Fan speed 2;
- Power Supply 1 - status;
- Power Supply 2 - status.

The screenshot shows a window titled "SOUND4 PULSE" with a dark background and white text. The window displays the following information:

Channel Name	SOUND4 - 21210024
PULSE:	1.56
PULSE Serial:	21210024
Main Board Temp (Max Allowed 70 °C):	51 °C
IO Board Temp (Max Allowed 70 °C):	42 °C
CPU Temp (Max Allowed 90 °C):	45 °C
Fan 1:	47 r/s
Fan 2:	45 r/s
Power Supply 1:	Failure Or Unplugged
Power Supply 2:	Running

A "Close" button is located in the bottom right corner of the window.

SETUP

Pressing the [Setup] button will open the basic set-up menu. Hence allowing some primary settings to be applied to the device. For detailed set-up, we recommend you to use the dedicated software.

Tools

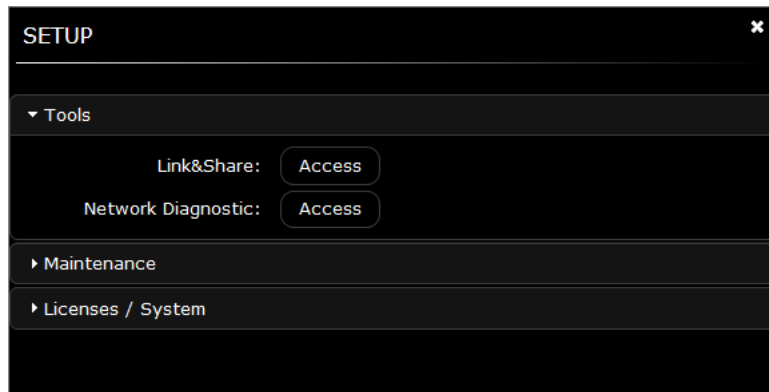

Link & Share

This tool is designed to allow remote control and monitoring of the devices across the network, using simple text commands via Telnet. The list of commands is available by clicking on [Access], then downloading the files to a directory of choice.

The file contains all commands, necessary syntax and parameters applicable to this device and its current version. Using Telnet access by port 3003, it is possible to type commands directly and see the values or change the parameters necessary, or it is possible to use various automation or script APIs to execute these commands to fully integrate SOUND4 products into your facility control and monitoring network.

Network diagnostics

Will open a window allowing the following diagnostics to be made: - PING, DNS, TRACEROUTE.



Maintenance

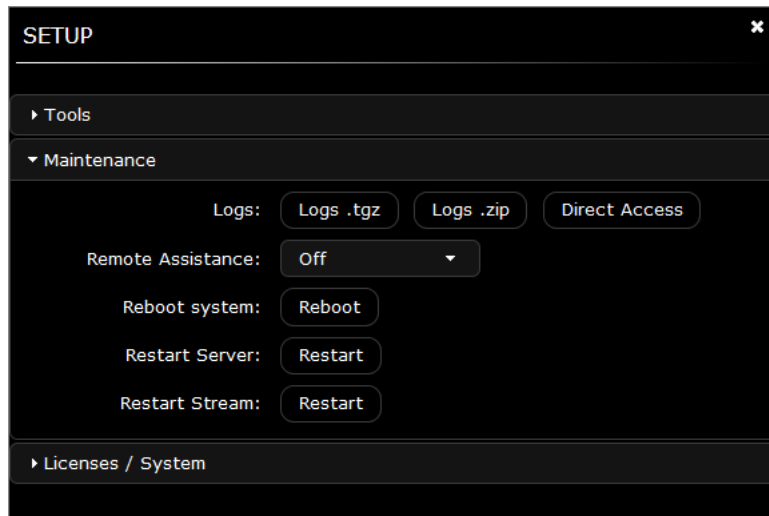

Allows you to download the Logs in .tgz and .zip files, as well as to access directly the *Index of /log* by pressing the [Direct Access] button. This is how the index will look like:

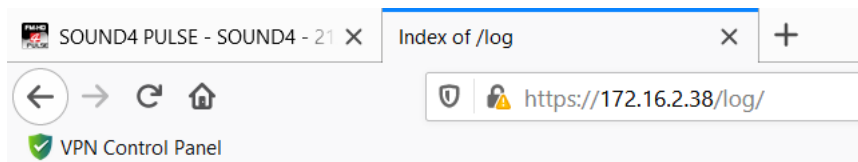

Index of /log

- [Parent Directory](#)
- [apache2/](#)
- [audit/](#)
- [crond.log](#)
- [log/](#)
- [messages](#)
- [messages.0](#)
- [messages.1](#)
- [messages.2.gz](#)
- [messages.3.gz](#)
- [messages.4.gz](#)
- [messages.5.gz](#)
- [messages.6.gz](#)
- [messages.7.gz](#)
- [mpd.log](#)
- [ntpd.log](#)
- [ntpd.log.1.gz](#)
- [ntpd.log.2.gz](#)
- [pppoe-server-log](#)
- [sa/](#)
- [sdcard.log](#)
- [sound4/](#)
- [test_system.log](#)
- [uboot.log](#)
- [uboot.log.1](#)
- [uboot.log.2](#)
- [uboot.log.3](#)
- [uboot.log.4](#)
- [uboot.log.5](#)

From here you can also enable the Remote assistance option, Reboot the System, Restart the Server and Restart the Stream.

Licenses/System

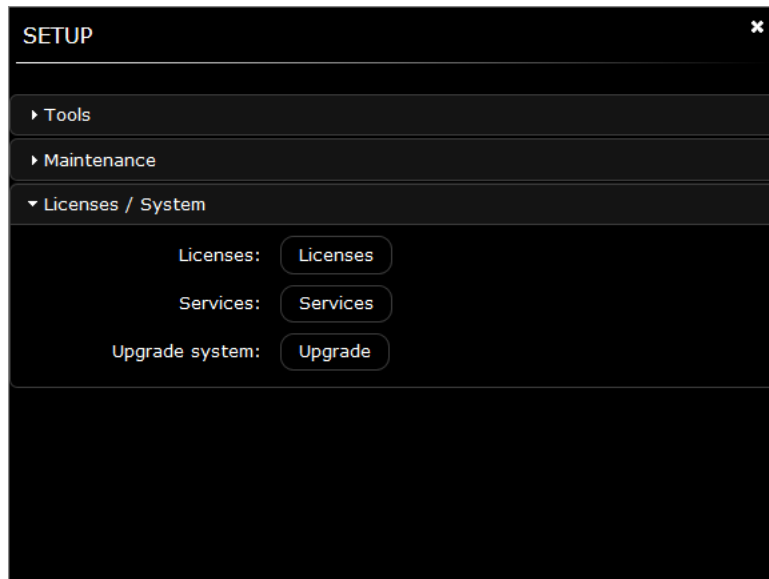

This section of the Setup menu allows you to:

Licenses

- review the currently used licenses and if needed update them by pressing the [Load license] button. Please note that the files should be unzipped when [Load License] option is used;

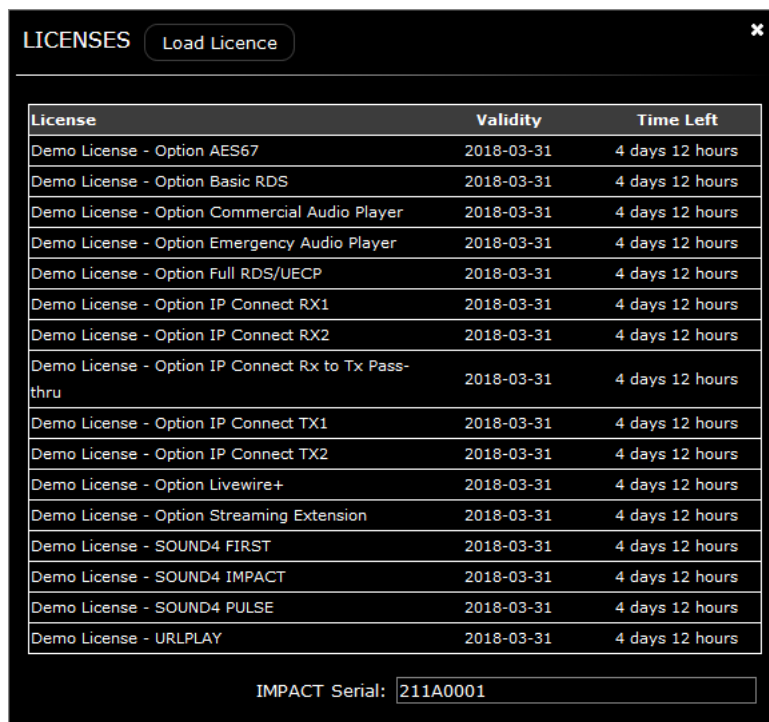

Services

- allows you to turn ON or OFF the Stream, Full RDS and Watermarking services.

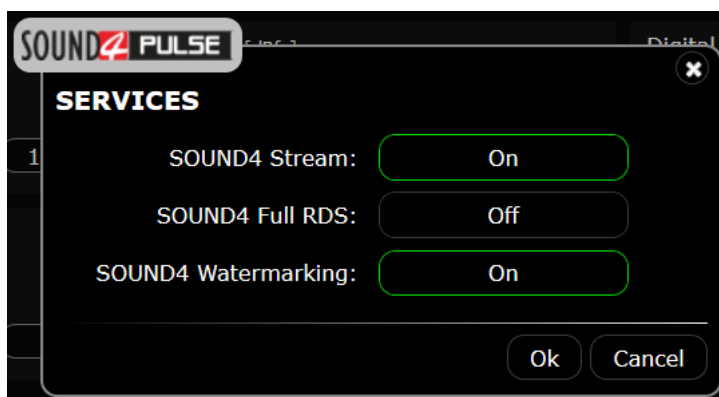

Upgrade

- allows you to upgrade the system to the latest version available. Please note that the files should be unzipped when upgrading the device;

Software

UNIVERSAL INSTALLER

The Universal Products Installer is the complete installation kit for all SOUND4 Products. The program is provided free of charge and can be downloaded from www.sound4.com/downloads. Installation packages for MS Windows and Linux Ubuntu OS are available.

Windows users

Upon entering the section, click on and download Universal All Products Installer. Once the process is completed install the .exe file. SOUND4's products are compatible with the Microsoft Windows Operating Systems listed below:

- Windows 7 - 32 & 64 bits
- Windows 8 - 32 & 64 bits
- Windows 10 - 32 & 64 bits
- Windows Server 2008 - R2
- Windows Server 2012

Linux Ubuntu OS

SOUND4 proposes you to install the software package under your own Ubuntu. Compatibility with Ubuntu distributions:

- Lucid Lynx - 10.04 LTS
- Precise Pangolin - 12.04 LTS
- Trusty Tahr - 14.04 LTS
- Xenial Xerus - 16.04 LTS
- Bionic Beaver - 18.04 LTS

Installation For a PC running compatible Ubuntu version:

Click on the following link to add SOUND4 repository -

www.sound4.biz/repository/ubuntu/sound4-repository.deb

If you also want to install:

- the SOUND4 Remote Control, please use the following link - apt://sound4remote

If you prefer to manage package installation by yourself, please follow the instructions below:

1. Add the following source to your Ubuntu repository list (example for lucid) -
[deb http://www.sound4.biz/repository/ubuntu/lucid-non-free](http://www.sound4.biz/repository/ubuntu/lucid-non-free.deb)
2. Then get the SOUND4 GPG signature key -
wget -q http://www.sound4.biz/repository/sound4.gpg -O- | sudo apt-key add -
3. Install required packages -
sudo apt-get update && sudo apt-get install sound4remote
4. Add the user to the audio group (needed for Alarm Stacker GUI) -
sudo adduser \$USER audio
5. Log off and on to make the settings effective.

CONNECTION

As explained, for the initial set-up of the device you will only need to connect:

- 1 of the power cables to PSU 1 socket;
- Connect SOUND4 PULSE to the TCP/IP network using a direct network cable, connected to the **ADMIN** port of the device **NOT to the IP ports**.

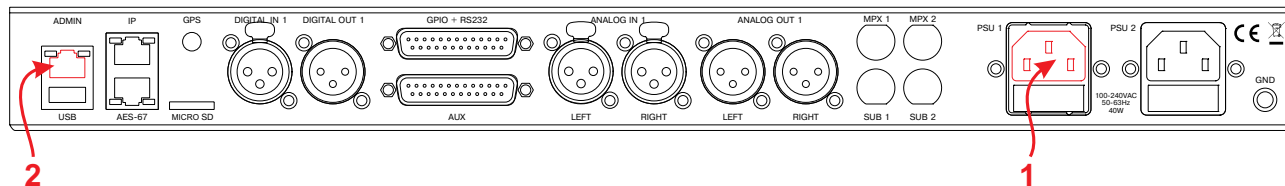

SOFTWARE

Double click on the software will open the main control window. The Remote control software can maintain several devices at once.

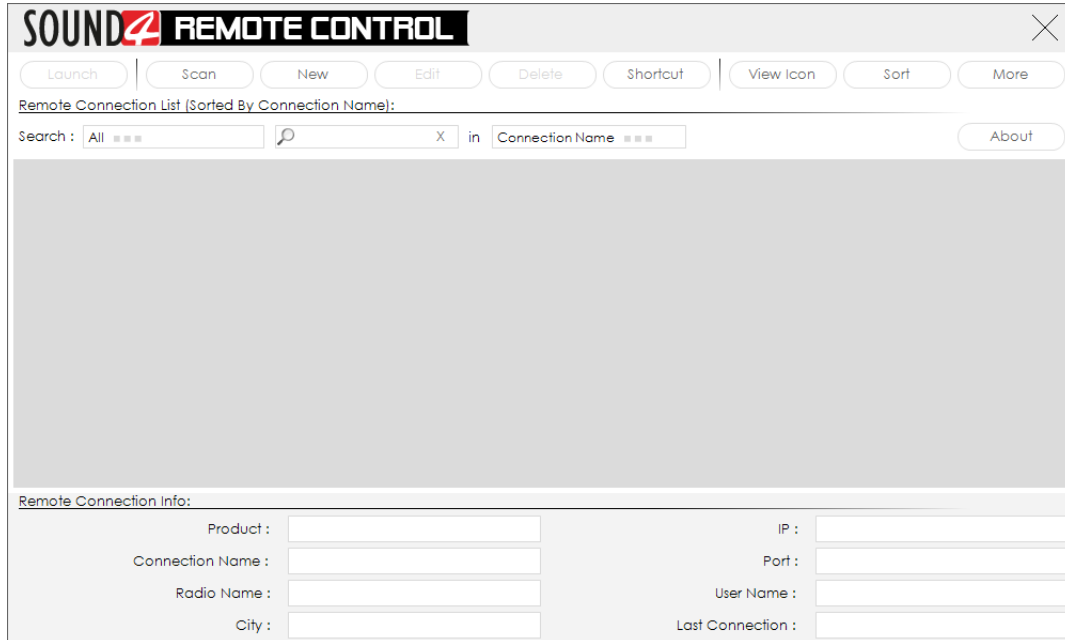

There are two options of adding a new device:

Scan interactive button.

1. Press [Scan];
2. Select the depicted IP address, and run [Scan];

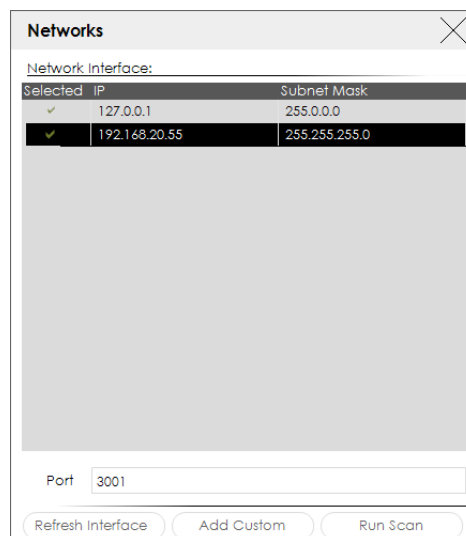

3. Wait until the process is completed;

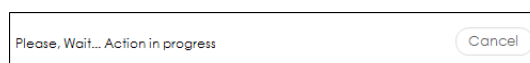

4. Upon completion of the scan, the following window will appear:

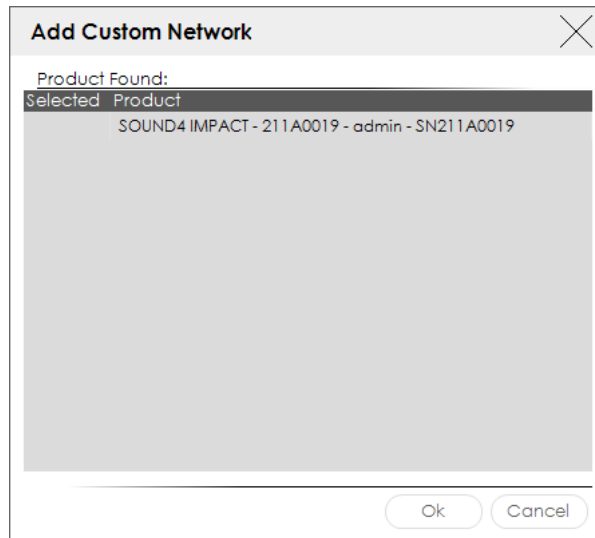

5. To add the device to the list, select the connection and press [OK];

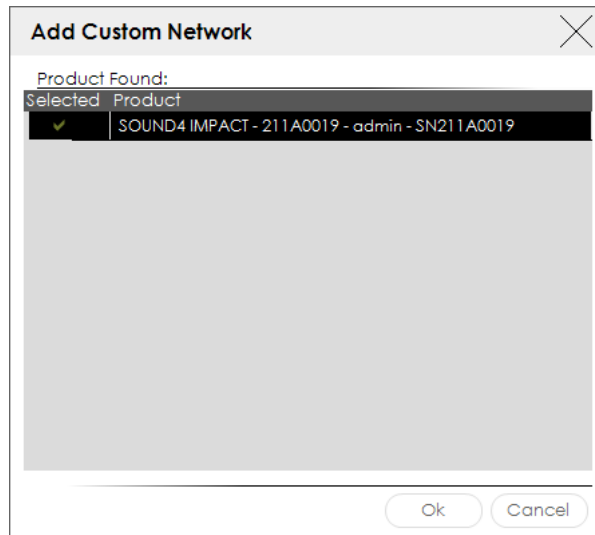

6. The device will be added automatically. Double click on the icon will open the device's interface.

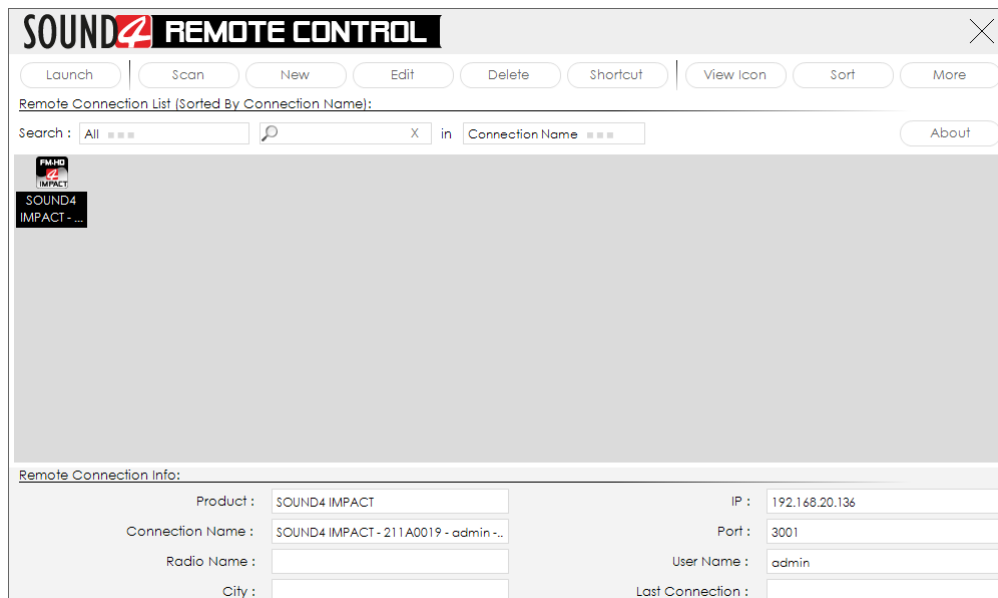

Add Device manually

1. Press the [New] button.
2. A new screen requiring the following information will appear:

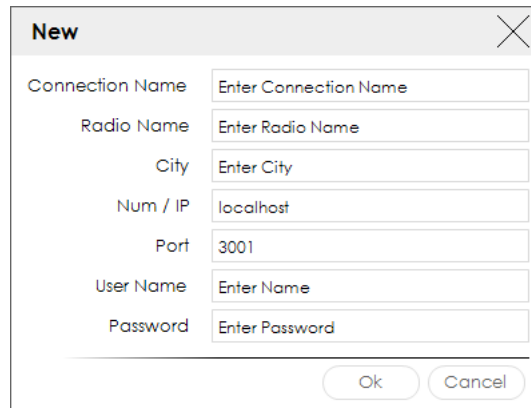

The 'New' dialog box contains the following fields and values:

Field	Value
Connection Name	Enter Connection Name
Radio Name	Enter Radio Name
City	Enter City
Num / IP	localhost
Port	3001
User Name	Enter Name
Password	Enter Password

3. If you are not aware of SOUND4's IP address, it can be seen via the front panel. When the Main screen is on, press the soft button labeled [INFO]. Then using the [Up] and [Down] buttons navigate to IP (2/4) where the IP address of the device will be depicted.

NOTE: The numbers included in the IP Address must be written without leading zeros. For example: 192.168.020.136 must be written as 192.168.20.136

4. Enter the required information. If not changed by the user, use the default value of the Port (3001). The username and password are as follows:
 - *User name* - **admin**;
 - *Password* - **admin**.

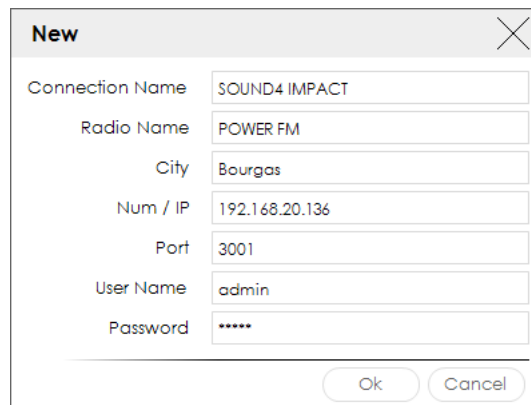

The 'New' dialog box contains the following fields and values:

Field	Value
Connection Name	SOUND4 IMPACT
Radio Name	POWER FM
City	Bourgas
Num / IP	192.168.20.136
Port	3001
User Name	admin
Password	*****

- Press [OK]. A new device will be added. Double click on the newly added icon will open the control interface.

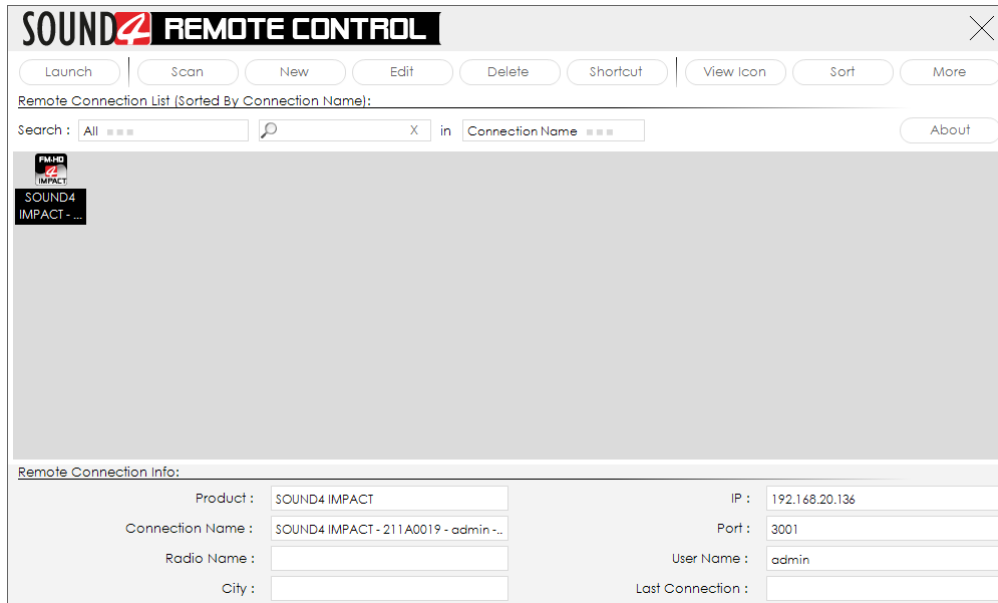

- A successful log-in the system will open SOUND4 PULSE's main control window:

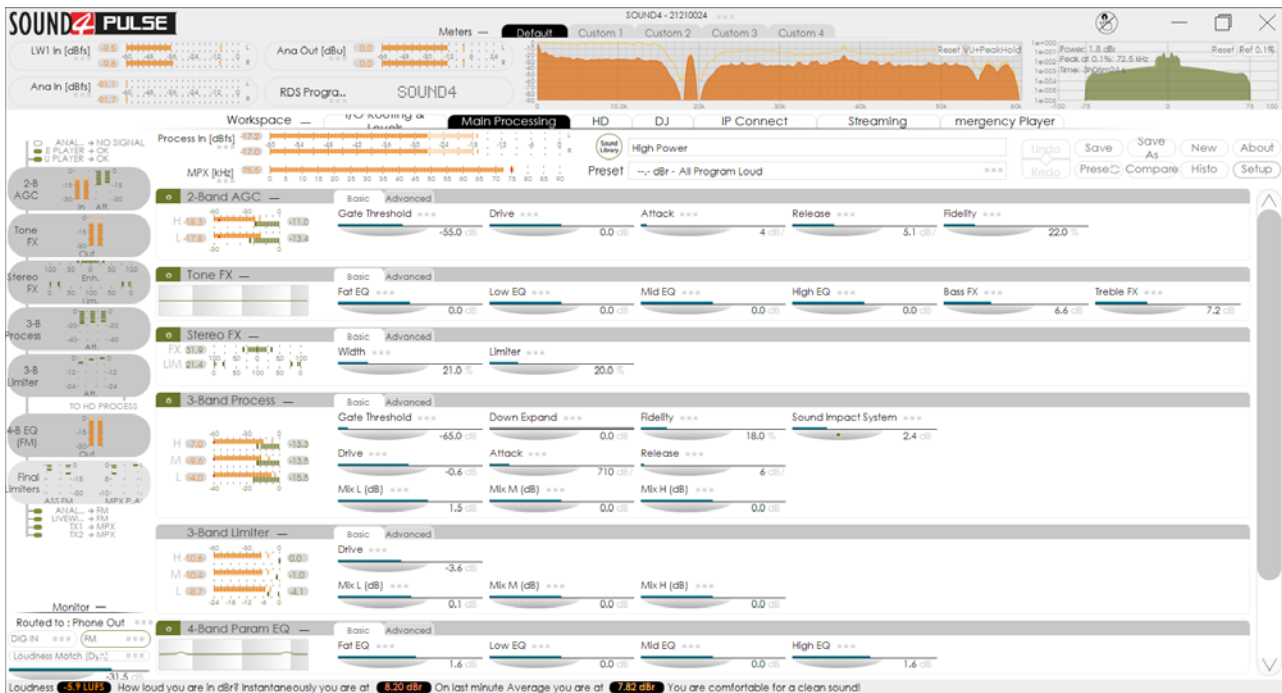

BASIC SET-UP

If not already done that, connect all the additional cables to the device in order for it to be properly integrated into your existing network.

Inputs and Outputs Set-up

The basic set-up of the inputs and outputs can be easily made via the I/O Routing and Levels section of the Software.

The management section is placed on the left part of the screen and is divided in two parts - Inputs to Patch Point Management (1) and Outputs to Patch Point Management (2). Both sections allow application of the inputs and outputs to be assigned as well as their range and levels.

The screenshot displays the SOUND4 PULSE software interface. At the top, there are several meters and a frequency spectrum analyzer. Below these, the 'I/O Routing & Levels' section is visible. On the left side of this section, there are two tables: 'Inputs To Patch Point Management' (marked with a red circle and the number 1) and 'Outputs To Patch Point Management' (marked with a red circle and the number 2). The 'Inputs' table lists various input types and applications, with 'LIVEWIRE+ 1' and 'LIVEWIRE+ 2' highlighted. The 'Outputs' table lists various output types and applications, with 'E Player' highlighted. To the right of these tables is a routing matrix with columns for 'Main Processing', 'HD Processing', and 'DJ Monitor'. Each column has a 'Direct' input and an 'In...' input. Below the routing matrix, there are several processing blocks: '2-B AGC', 'Tone FX', 'Stereo FX', '3-B Proc', '4-B EQ (FM)', 'FM Limiter', and 'MPX Limiter'. At the bottom of the interface, there is a 'Loudness' meter showing values like -7.3 LUFS, 6.51 dBr, and 7.14 dBr.

The set-up process is different for each parameter, but quite simplified and explained in details below:

Inputs Set-up

1. Click on the name of the desired Input;

- The respective set-up window will appear. Apply the desired settings and press [X]. The changes will be automatically saved.

For the Analog inputs - set Input Range and Input full-scale Reference:

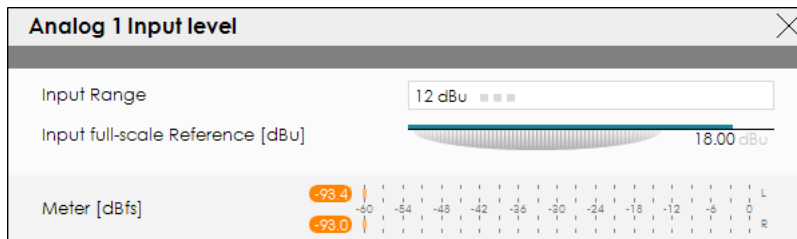

For the Digital Inputs, Emergency Player, Zetta Player and the Emergency URL Player Input level - set Input full-scale Reference:

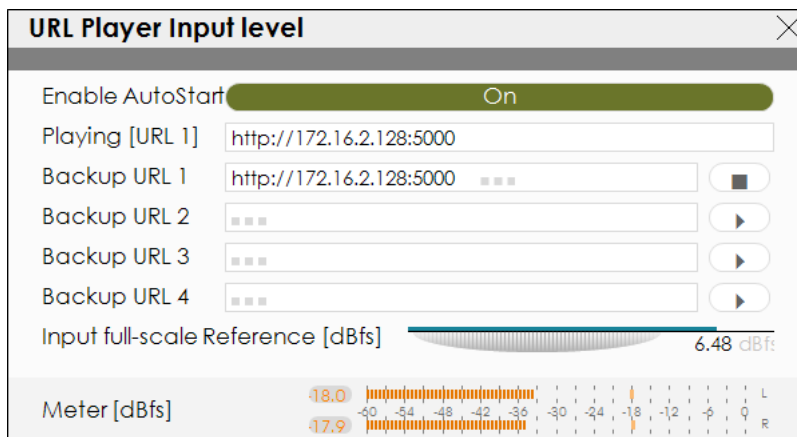
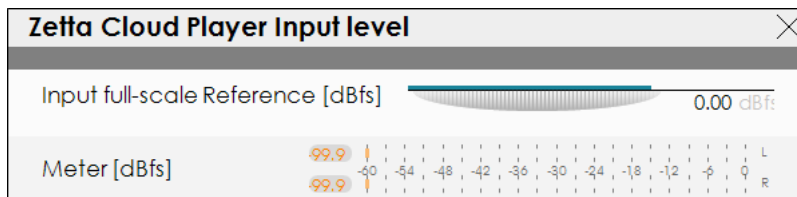
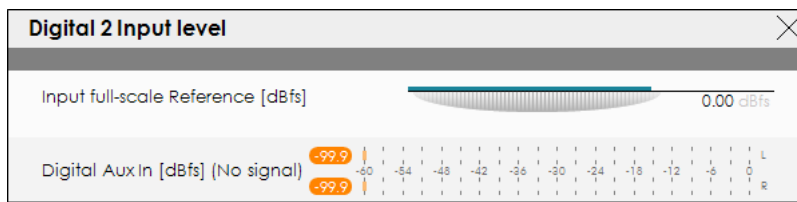

To set up URL Player open the drop down window from the Sources list.

Emergency URL player allows you to define up to four URL addresses from media servers to be played as your backup in case if main source fail. It can receive audio from Shoutcast or Icecast HTTP servers and currently can decode MP3, AAC, HE-AAC, HE-AACv2, Opus, Vorbis and FLAC encoded streams. The Player is trying to play audio from URLs from 1st to 4th. **Autostart** allows to turn playback automatically in case of main source failure. As soon as one URL is operational, it stays on it. If for some reason the reading of this URL was stopped, it will continue to the next address. If it is not possible to read any streams, there is a delay of 3 seconds before the Player tries to find a valid address in the list starting 1 to 4 again.

For the LIVEWIRE inputs - Enable the input by selecting [ON] with a click, then select LAN mode by clicking on [LIVEWIRE ...], number of channels, From/To Source, Primary Source Name, Local Name, Stream mode, Status and Input full-scale Reference:

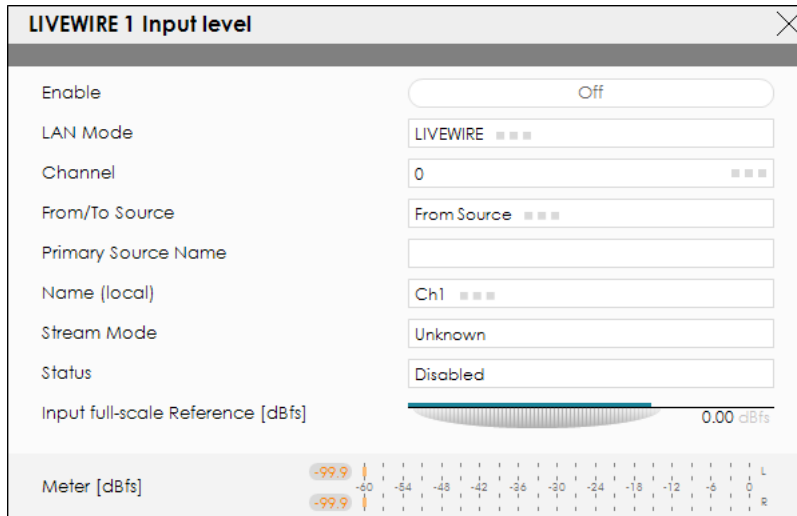

3. To assign application of the Input, press on the Process Input label or on ... (if such is not assigned to the input);
4. A window with the possible options will appear. Click on the one preferred and the window will disappear, automatically assigning the chosen value.

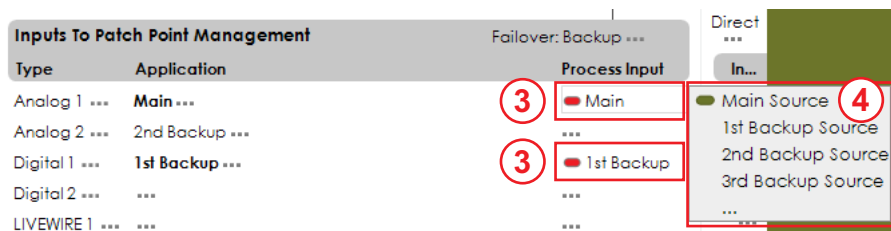

Outputs Set-up

1. Click on the name of the desired Output;
2. The respective set-up window will appear. Apply the desired settings and press [X]. The changes will be automatically saved.

For the Analog Outputs - set Output range, select Application from the drop-down menu, then Auto De-emphasis and Output full-scale Reference:

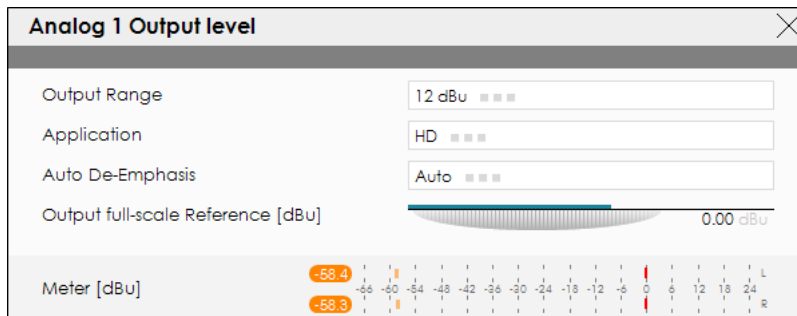

For the Digital Output level - select Application from the drop-down menu, then Auto De-Emphasis, Sampling Frequency, AES In Sync, AES 2 In Sync, Use External Word clock, Ext. Video Sync and Output full-scale Reference:

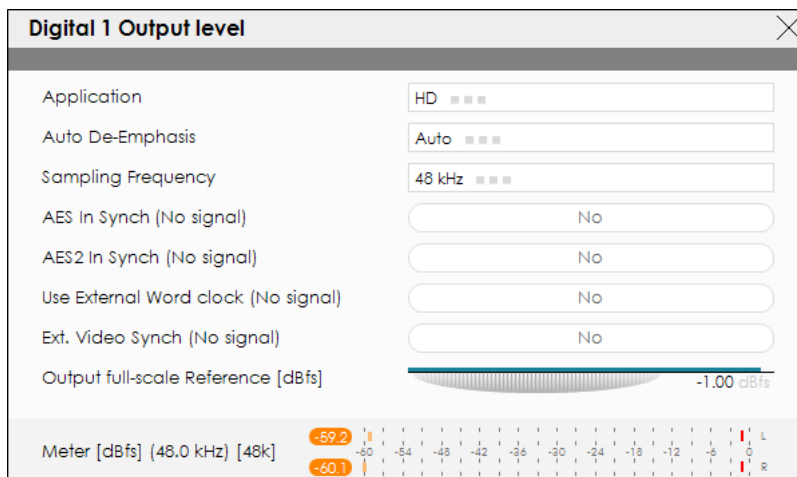

For the LIVEWIRE Output level - Enable the output by selecting [ON] with a click, select profile by clicking on [Livewire Live Audio...], number of channels, Name, Label, Status, Configure GPO, select Application from the drop-down menu, then Auto De-Emphasis, and Output full-scale Reference:

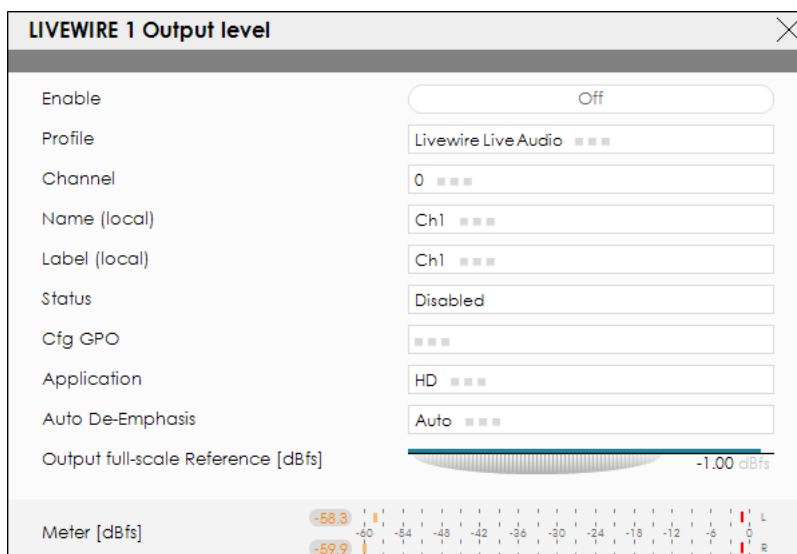

For the IP Connect level, Stream Output and WebMon level - select Application from the drop-down menu, then Auto De-emphasis and Output full-scale Reference:

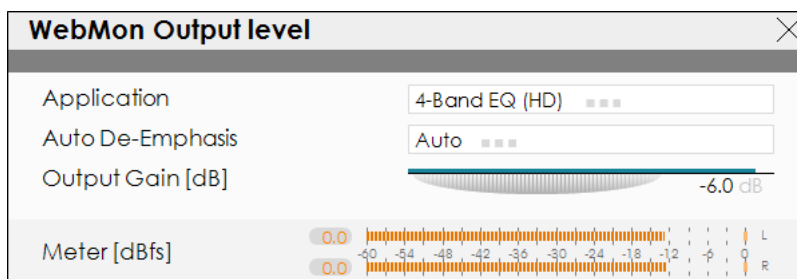
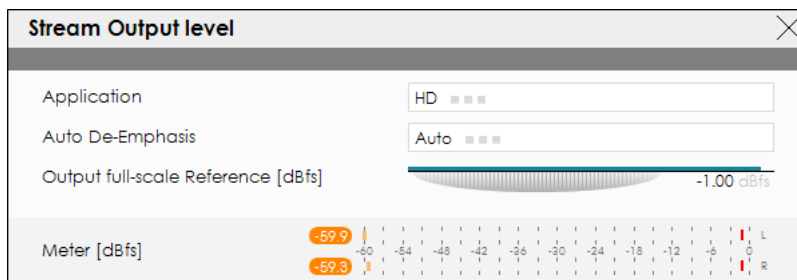
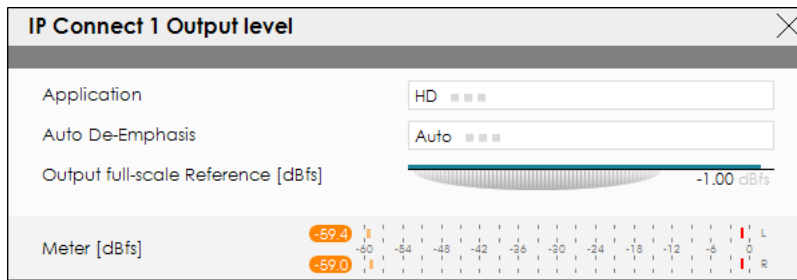

For the Loudness Measurements Settings - select Application from the drop-down menu and define all the corresponding parameters as needed.

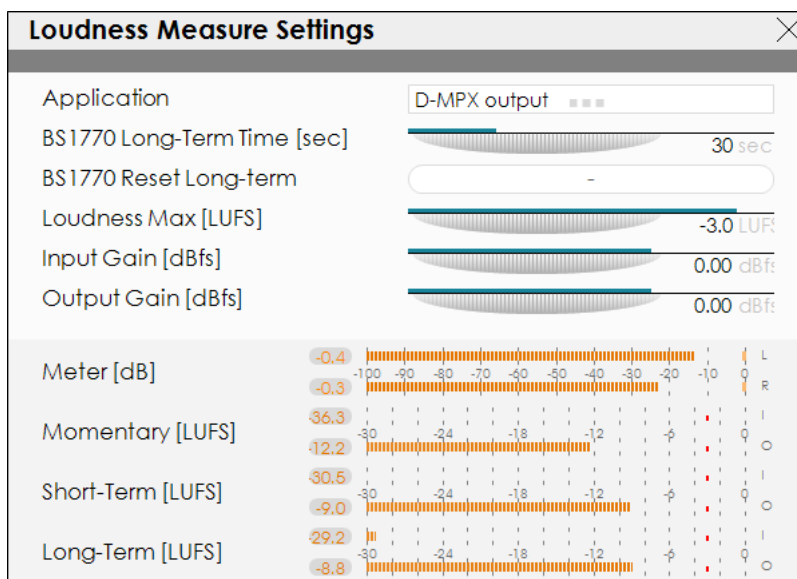

3. To assign Replicate of the Output, press on the Replicate label or on ... (if such is not assigned to the output);
4. A window with the possible options will appear. Click on the one preferred and the window will disappear, automatically assigning the value chosen.

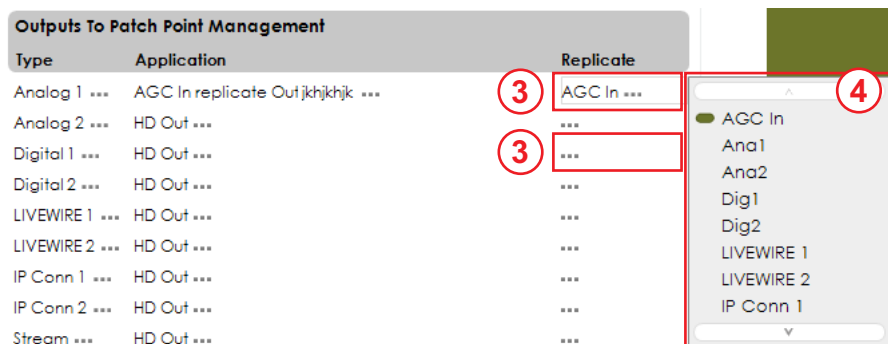

Preset selection

To select a preset, press on [Preset] button (1), and list of all presets will appear on the screen.

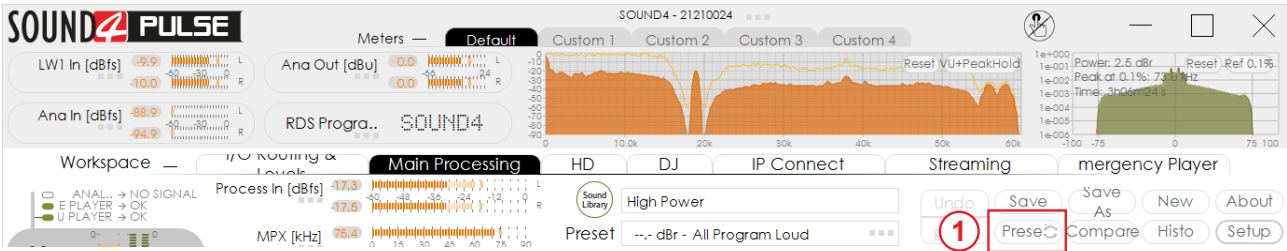

Double click on the desired preset will load it automatically to the device.

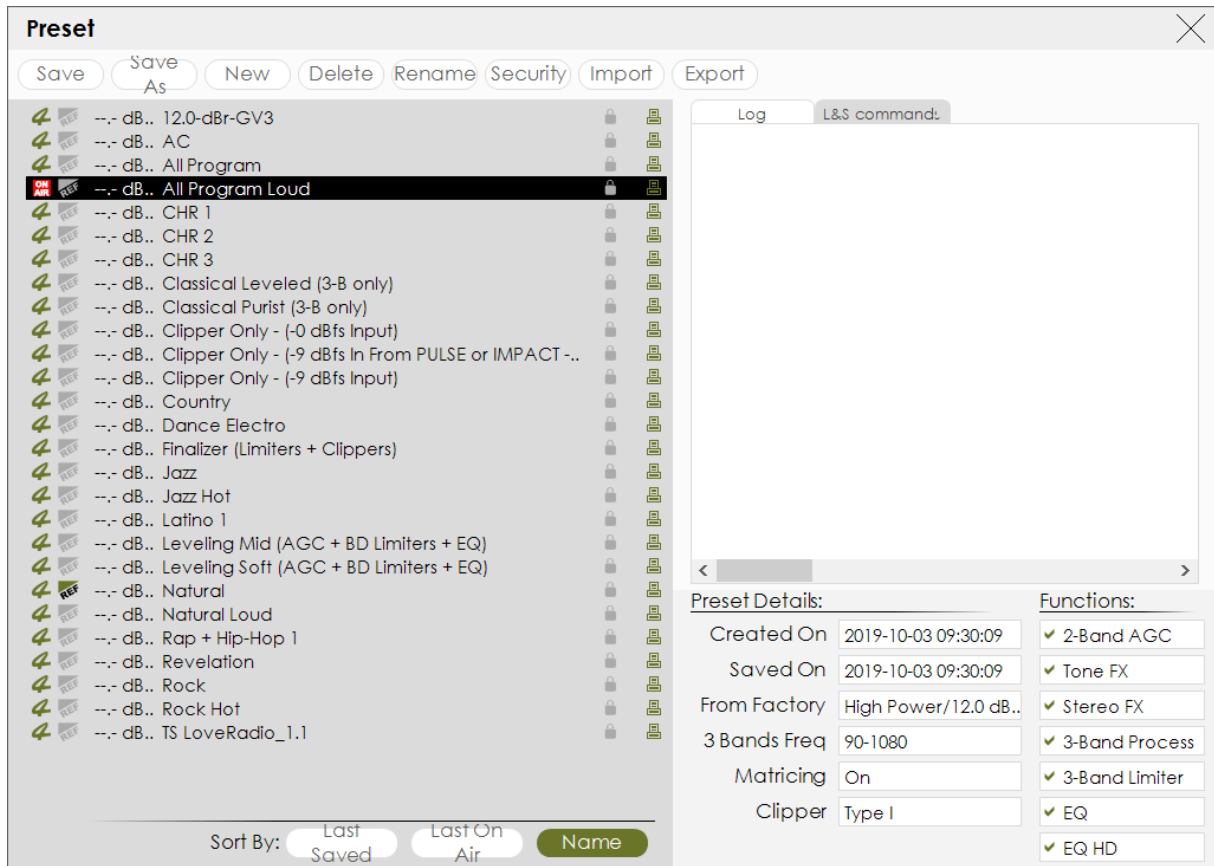

Operating Guide

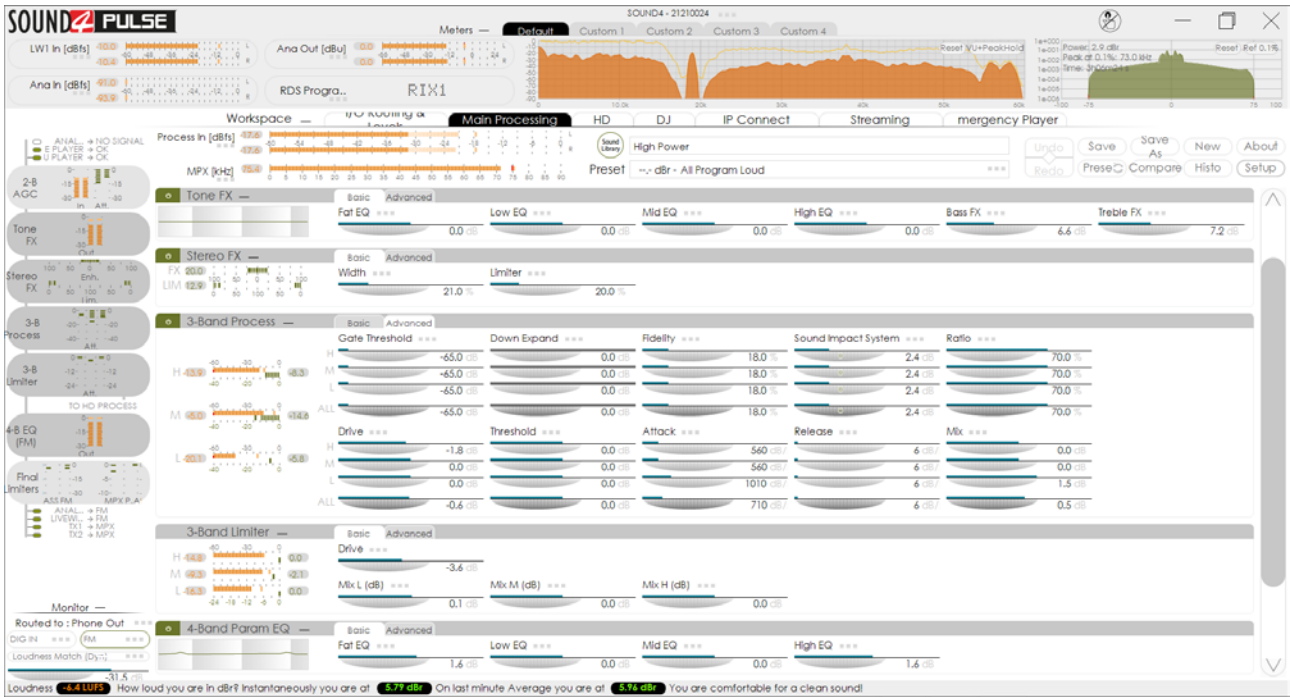

TITLE BAR CONTENT

The title bar menu is constant part of each tab. Thus, allowing reading at a glance of all the mandatory parameters. The title bar can be hidden by clicking on Meters.

It's content can be customized as per the user's requirements. The interface allows you to choose between several layouts - **Default**, **Custom 1** to **Custom 4**. The visual content of each is customizable and the possible options are depicted below.

NOTE: A click on Meters will hide the title bar.

Default

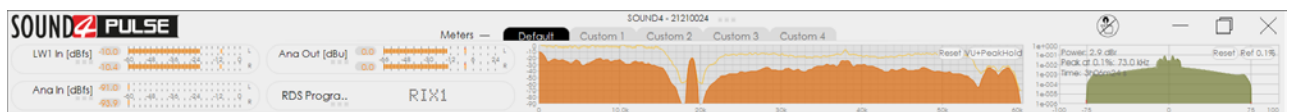

Custom 1

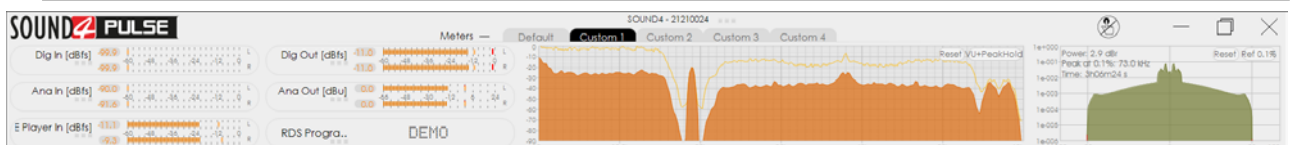

Custom 2



Custom 3

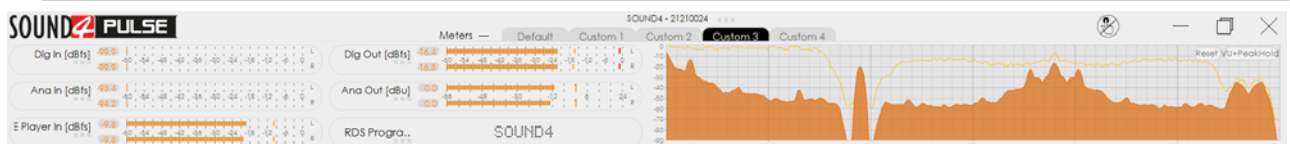

Custom 4



Customized title bar

Each layout displays several interactive indicators represented as follows:

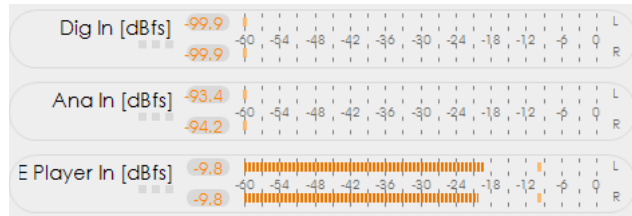

To change the content, click on one of the indicators. Then from the menu, select the content from one of the following groups:

Input/Output

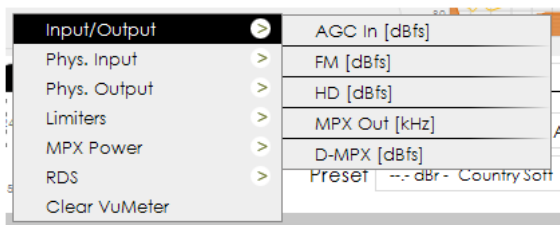

Phys. Input

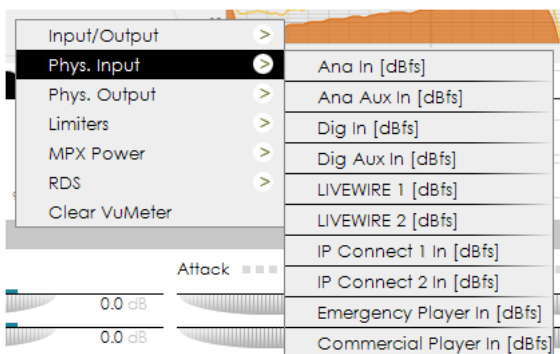

Phys. Output

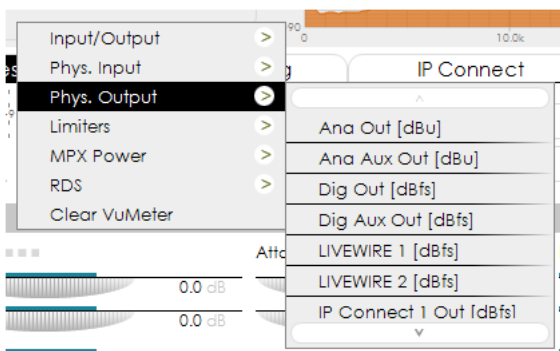

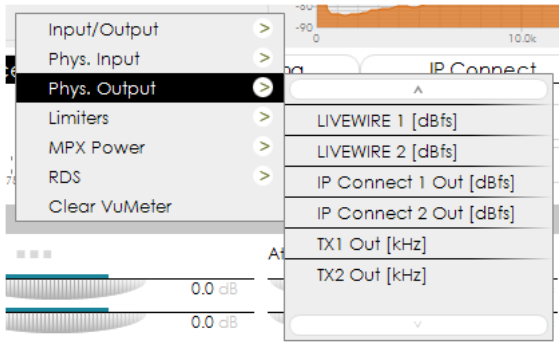

Limiters

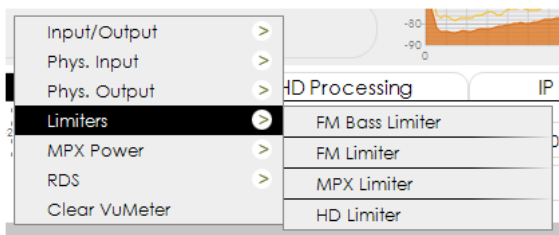

MPX Power

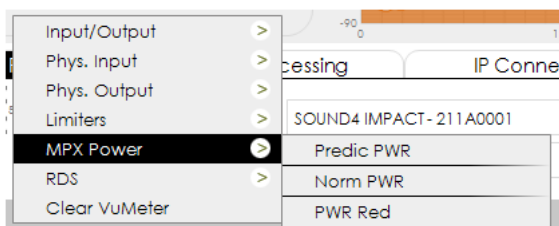

RDS

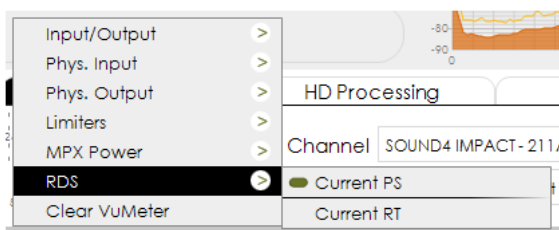

Clear VuMeter will leave the parameter space blank:

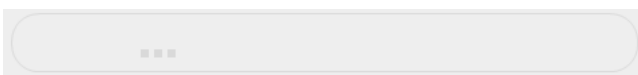

To change the measuring limits of the indicator, when clicking on such a window allowing not only change of the content, but also of the range or measurement units will appear. Select the preferred value, and it will be automatically applied to the indicator.

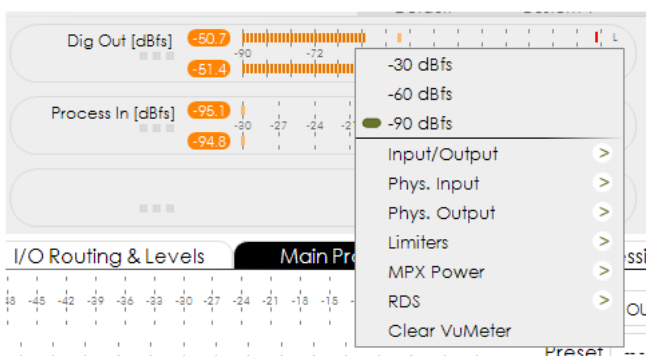

Depending on the chosen layout, the following graphics may be available:

FFT MPX

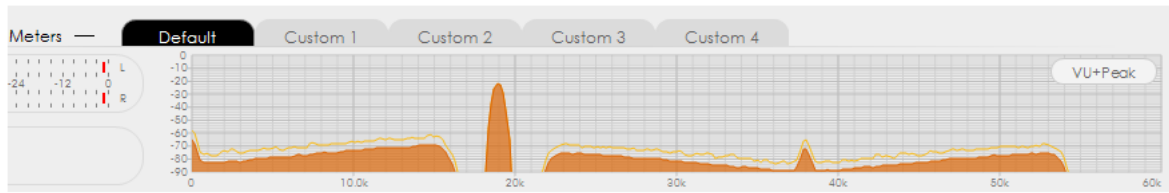

MPX Power

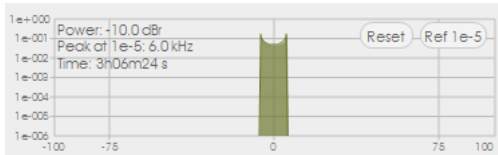

Double click on a peak or at a specific place on the graphic will open a magnified window of the selection, hence allowing detailed reading of the parameters.

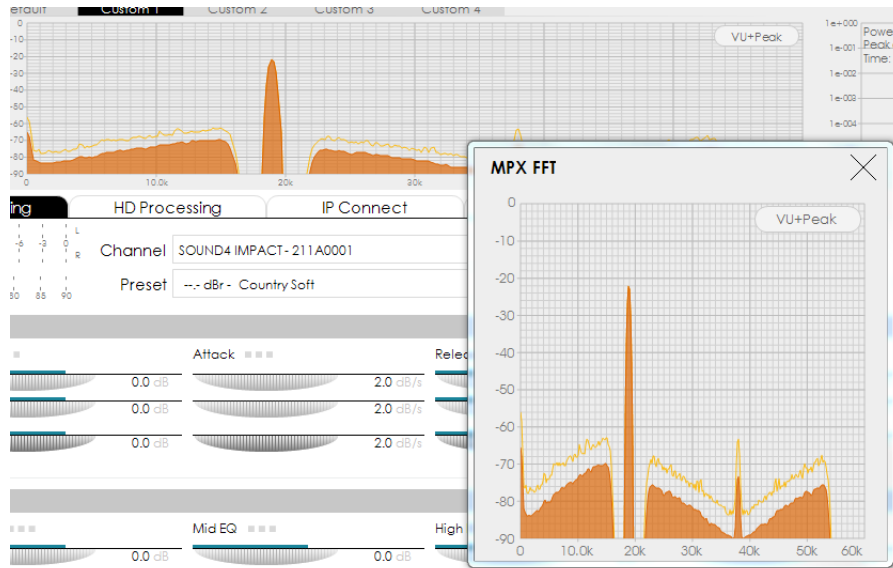

FFT MPX magnified

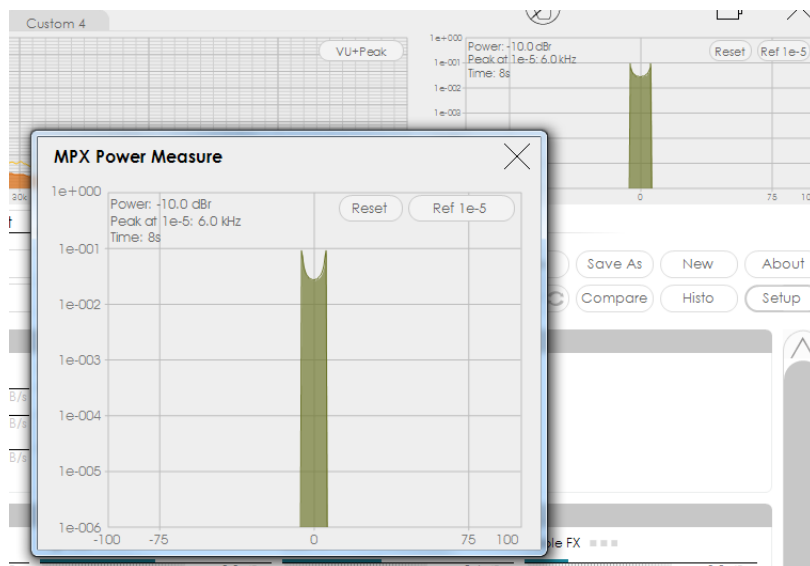

MPX Power magnified

MAIN PROCESSING

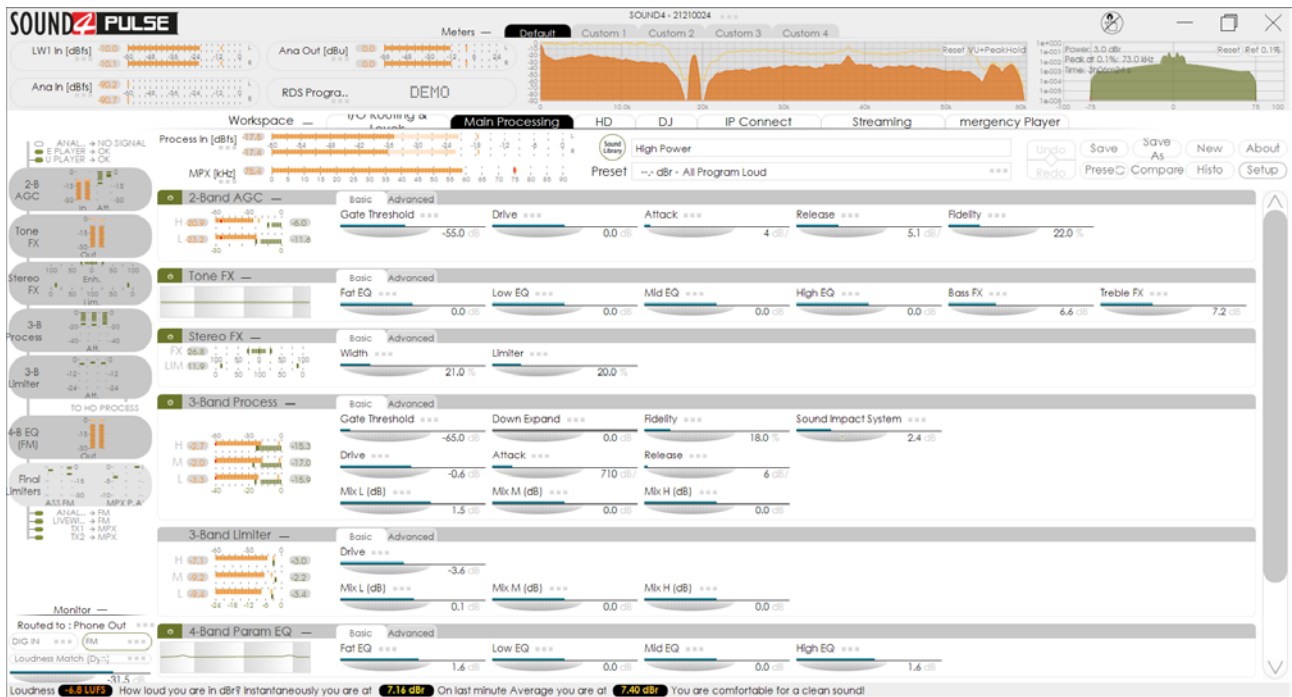

Contains all the important processing parameters. As each block of settings is set individually, a combination of basic and advanced settings can be made. Below you will find explanation on the processing functions and meters.

We will start with explanation of the options placed on the left part of the interface:

Meters

- depicts the current values of each parameter, and the Inputs in use.



Monitor

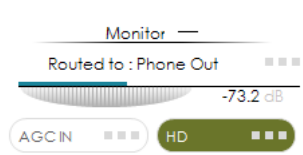

The content of the section is user-defined. By default it is set to Phone Out. It can be changed with a click on the [...] symbol. A new window with the available options will appear.

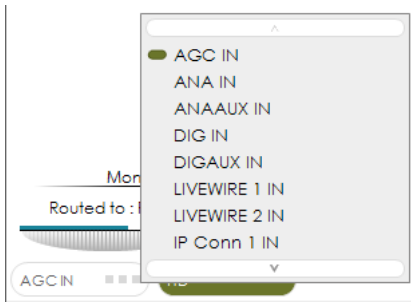

Each parameter can be individually customized also if the [...] symbol is available against the labeled menu.

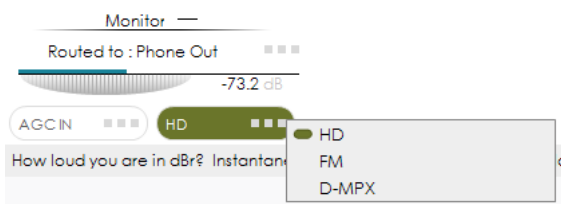

Meters and Settings



This menu is constant part of the Main and HD Processing, and contains the following options:

1. Process and MPX interactive LED meters;

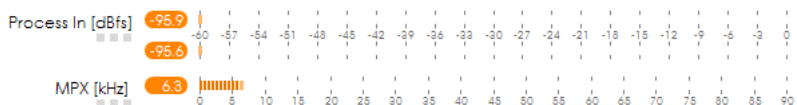

2. Channel name and preset in use (customizable);



3. Interactive buttons - are generally related to the Presets.

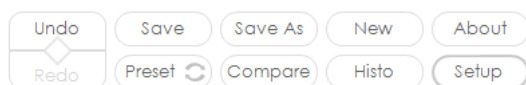

[Undo]/[Redo] - will undo or redo the settings applied to the Main or HD processing settings.

[Preset] - To select a preset, press on [Preset] button, and list of all presets will appear on the screen.

Double click on the desired preset will load it automatically to the device.

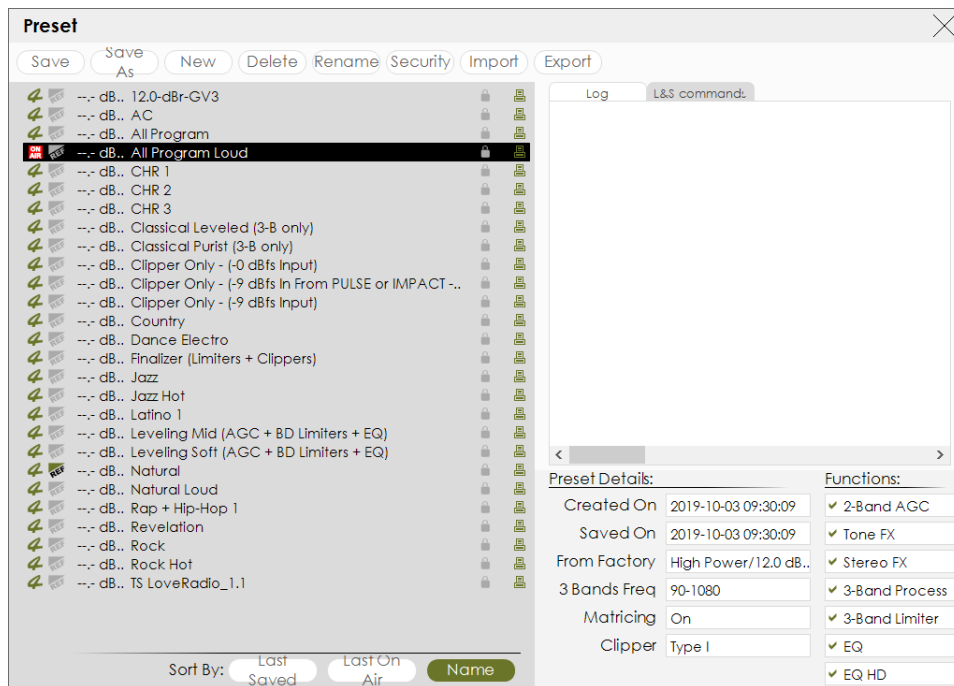

The preset can be used as it is, or some changes to the parameters can be applied.

[Save] - If changes to the parameters involved in the current preset are made, upon pressing the [Save] button, the changes will be saved to the currently loaded preset.

[Save as] - Allows the user to create a new preset if changes to the parameters involved in the current preset are made. User defined name could also be set.

[Compare] - A list of presets will be loaded. Then you can click on a preset of choice and then on [Reference]. Upon pressing the button, the software will toggle between the settings of the two presets allowing a comparison to be made.

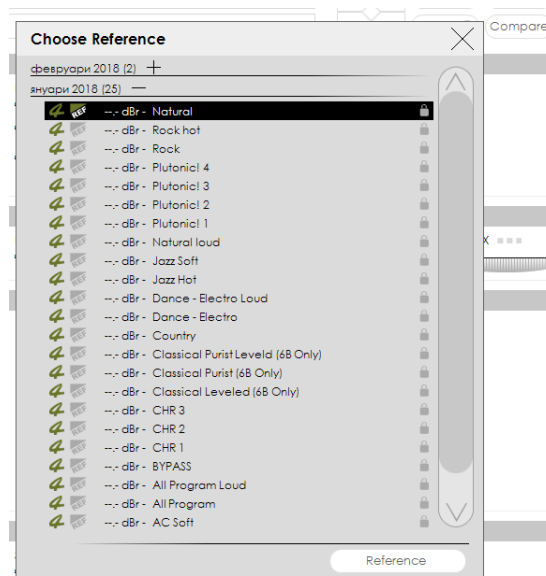

[New] - Allows new preset to be created. For detailed information on the process, please refer to [“How a preset can be made” on page 81](#).

[History] - Will open a window with list of the presets used.

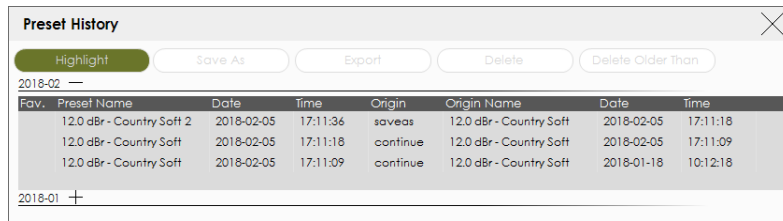

[About] - Will open a window with the following options.

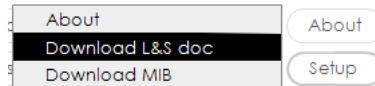

SOUND4 provides great feature throughout its product line: Link & Share. This tool is designed to allow remote control and monitoring of the devices across the network, using simple text commands via Telnet. The list of commands is available by clicking on About in the remote control window, then choosing **Download L&S doc**. The Resulting XML file contains all commands, necessary syntax and parameters applicable to this device and its current version. Using Telnet access by port 3003, it is possible to type commands directly and see the values or change the parameters necessary, or it is possible to use various automation or script APIs to execute these commands to fully integrate Sound4 products into your facility control and monitoring network.

Download SNMP MIB File - The MIB file may vary from one firmware revision to another. Downloading this file from the device, guarantees that you have the proper MIB file.

[Set-up] - will open the set-up menu. For detailed information on the process, please refer to [“Setup” on page 84](#).

How a parameter can be set

Each individual parameter can be set and generally turned ON or OFF. This is made by the interactive sliders or by pressing on:

1. The [...] symbol, and a set-up window will appear;
2. Turn the parameter [ON] or [OFF];
3. Set the de desired values.

The applied changes will be automatically saved.

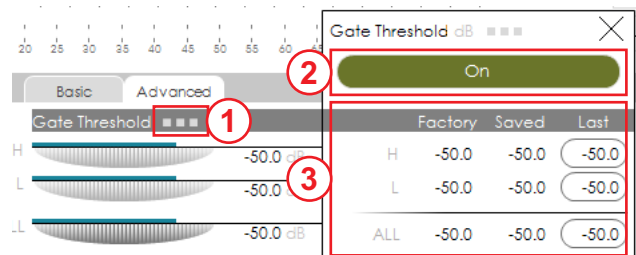

Basic and Advanced AGC

The first processing stage is AGC - automatic gain control that works across large band of frequencies. It is intended to bring to normal the differences in the audio levels applied at the input. It corrects strong sound variations without pumping effects.

Basic AGC



Advanced AGC



Gate Threshold – When the audio drops below the user-defined limit, the threshold will freeze the processors' operation. This function limits the floor noise when the signal is low.

Drive – increases or decreases the gain at the AGC input. Increasing the drive will make up for very low levels, and decreasing it (very low drive) will prevent low level corrections at the processor input.

Attack – To adjust the AGC reactivity speed to a volume increase, adjust the attack in dB per second.

Release – sets the AGC correction speed in dB per second. As the AGC itself is very powerful tool, it is not necessary to use high Release speeds. For example, we recommend using 1 and 1.5 for classical music and 2 for other programs.

Fidelity – is intended to maintain the fidelity and spectral balance of the original input signal. If turned [Off], the bands will be working independently.

Basic and Advanced Tone FX

Enriches the sound color before dynamic processing. There are two modes - Basic and Advanced Tone FX. The spectral display (placed on the left of the settings) illustrates in real time the general correction applied by the parametric equalizer.

Basic Tone FX



In this mode the only adjustable options are:

- For Fat EQ, Low EQ, Mid EQ, High EQ is the gain;
- For Bass FX only one effect variable is available.

Advanced Tone FX

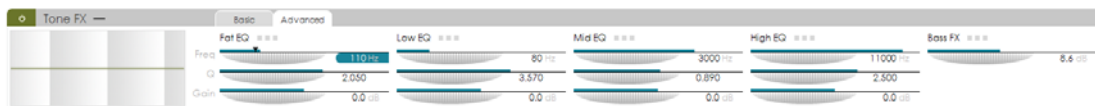

All the parameters of the parametric equalizer are available In Advanced Tone FX mode:

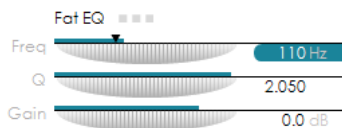

- Freq** – Parametric band center frequency;
- Q** – Applied filter quality (parametric band “width”);
- Gain** – Gain of the parametric band.

Basic and Advanced Stereo FX

The role of the Stereo FX (stereo enhancer) is to improve the existing stereo image. While enhancing the stereo image, the Stereo FX can also work to control the energy transmitted by the stereo subcarrier at 38 kHz with stereo image limiter.

The FX VU meter (placed on the left of the settings) illustrates the enhancement rate generated by the processor. The indicator moves from the middle to the outside borders of the meter. The LIM VU, on the other hand, depicts the limitation percentage on the subcarrier at 38 kHz.

Width – sets the stereo enhancement rate. Setting it to 20 and 40% is usually a sufficient value.

Limiter – sets the stereo image reduction compared to a 100% max rate. If the option is used, the recommended percentage value is between 10 and 15%.

Basic Stereo FX



Advanced Stereo FX



Basic and Advanced 3-Band Process

The multi band process is the core of the SOUND4 PULSE. A unique set of options controls each band, hence ensuring perfect sound stability.

Basic 3-Band Process

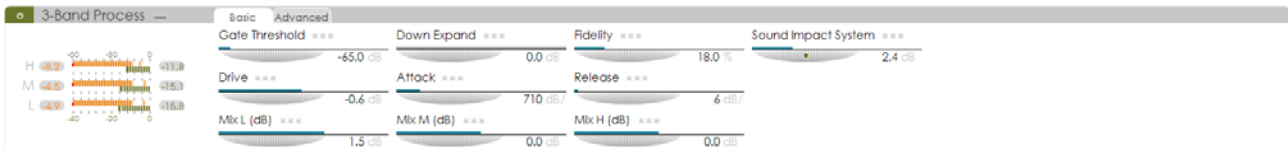

The basic mode applied the same setting to all 6 bands used in the process. The settings are explained in details below.

Advanced 3-Band Process

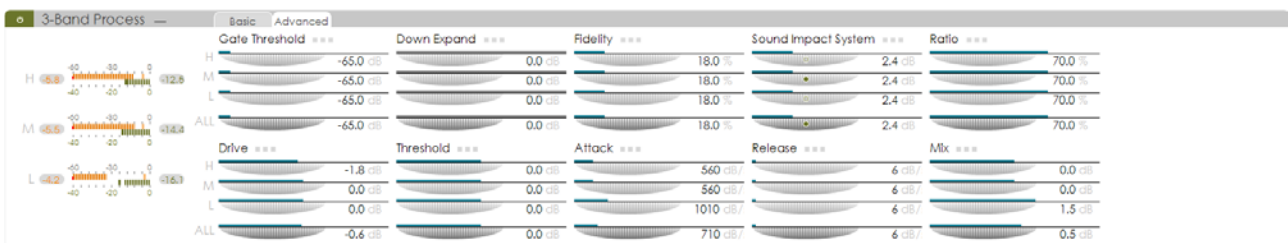

When used in advanced mode, the 3-Band Process allows different settings for each band to be applied. The bands are always organized as follows:

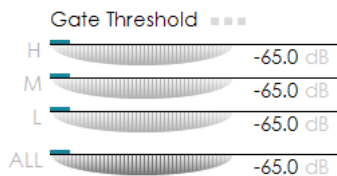

H - High frequency band
 M - Mid frequency band
 L - Low frequency band

Gate Threshold – freezes the operation when the audio drops below the defined limit. When the signal is too low, the Gate Threshold function will limit the floor noise.

Down Expand – the option works only when the corresponding band is frozen by Gate Threshold. It is intended to retain the attenuation on the user-defined value. Then, according to the set attack and release timed, the Down Expand automatically returns to the configured value. The combination Gate Threshold + Down Expand is very useful when noisy sources such as microphones are evident.

Fidelity – controls the spectral balance between the bands. For example:

- If Fidelity is set to 0, the sound will be more rich as the bands will work independently;
- If Fidelity is set to 100, the sound will be purer as the bands are linked to the spectral distribution at the input.

Sound Impact System – maintains the authenticity of the original sound attacks. Pay special attention when using the Sound Impact System with values higher than 6 as the average power of the sound will significantly increased. In this case you may need to lower the Band Limiter or Final Limiter drive.

Drive – creates more or less gain at the band’s input. The band process power allows for gain control within the bands without the use of wide band AGC. If the AGC is not used, we recommend the drive to the bands to be “pushed” so that the reduction could be sufficient enough to correct the low levels. generally speaking:

- increasing the drive will lead to reduction in the gain created by the band process, hence making-up for the very low levels;
- a very low drive will prevent low level corrections.

Threshold – sets the working limits of a band. It can also be used to bring bands from the background to the foreground and vice versa.

Attack – Adjust in dB per second to set the processor’s reaction speed for each band. Lower value will slow the processor’s reaction, and vice versa - the higher the value, the faster will the processor reacts, hence controlling the rapid variations.

Release – (often associated with density). The higher the release, the higher will the spectrum density within the band be. As the Band processor is very powerful tool, it is not necessary high release times to be set in order for higher density levels to be obtained.

Mix – If considering the signal as a quantitative value, the Band Mix function gives control over the amount of each band that participates in the signal. The preferred values are set via the relative Gain sliders (in dB). An option to disable a particular band for the currently selected preset is also available.

Basic and Advanced 3-Band Limiter

The SOUND4 PULSE has a 3-Band Limiter that uses a powerful predictive algorithm and is intended to prepare the audio for the final limiter.

The VU meters are placed on the left side of the parameters, and show the gain reduction of each band.

Basic 3-Band Limiter



Advanced 3-Band Limiter

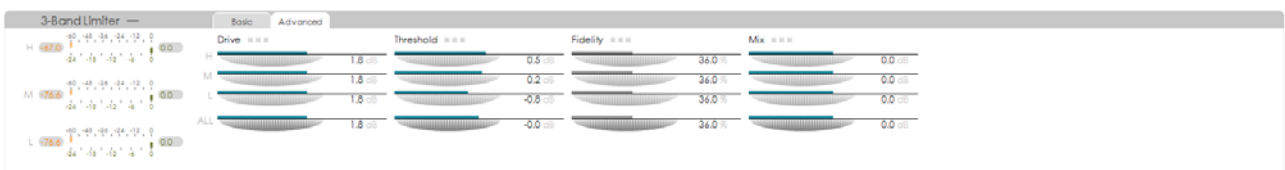

Drive – creates more or less gain at the 3-Band Limiter’s input.

Threshold – sets the working limits of each limiter band.

Mix – used to define the output level for each band so as to obtain the best sound balance.

Basic and Advanced 4-Band Program EQ

The four separate sections of ‘parametric’ equalization can be attributed to any combination of **Freq** (frequency), **Q Factor** (bandwidth) and **Gain** (amplitude). These may be assigned to any combination of Fat EQ, Low EQ, Mid EQ and High EQ.

Within each section of parametric equalization, the **Freq**, **Q Factor** and **Gain** are individually adjustable. As each EQ slider is moved, the resultant change in response, both in that EQ section and its overall contribution, is shown on the graph. The graph placed on the left of the parameter, displays the individual frequency response of each of the four equalizer bands and the summary frequency response of the entire EQ section, including pre-emphasis.

Fat EQ – represents the lowest band, and is very useful for eliminating problematic rumble or hum frequencies, or making the low end “punch” pop through.

Low EQ – used for cutting some of the typical low midrange “mud” caused by the proximity effect or to help enhance the classic sound.

Mid EQ – adds intelligibility and clarity in the critical midrange frequencies.

High EQ – will enhance the top end.

Basic 4-Band Program EQ



Advanced 4-Band Program EQ

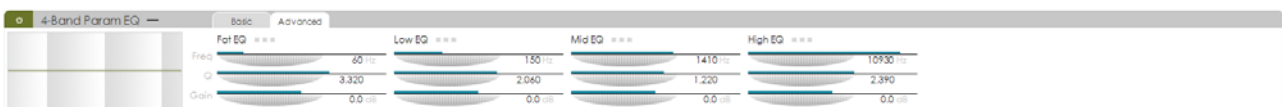

Basic and Advanced Final Limiter

Allows setting of the final peak limiting stages. The Final Limiter detects and removes (almost) any distortion that is audible by the human ears. This results in an extremely clean sound.

Basic Final Limiter



Advanced Final Limiter



MPX Power Target – controls the amount of limiting performed by the MPX Power limiter in the range of 12.0 dB.

LF Clip Threshold – sets the threshold of the LF Clip (the level at which the clipper will start working). Increasing the threshold reduces the amount of clipping performed by the LF Clip. Lowering the threshold will bring more bass clipping, which may result in low frequency distortion if set too low.

FM Limiter Drive – This extremely powerful clipper works at 1.5 MHz sampling frequency. It is intended to control the gain at the FM Limiter Input. Pay special attention when increasing the FM limiter drive as this may lead to significant distortion. Note that the more you load the final limiter, the more the MPX power will be increased. The regulation level must be strictly observed when MPX power control is activated, as otherwise the MPX power level may attenuate as you increase the limiter drive.

MPX Limiter Drive – The complex process works directly on the audio signal. It is intended to obtain the positive effects of the MPX limiter (loudness) without the bad side effects (uncontrolled noise levels).

Embed Pilot – Enables/Disables the option.

MPX Power StandBy – adjustment of the MPX clipper. Set in dB.

I/O ROUTING & LEVELS

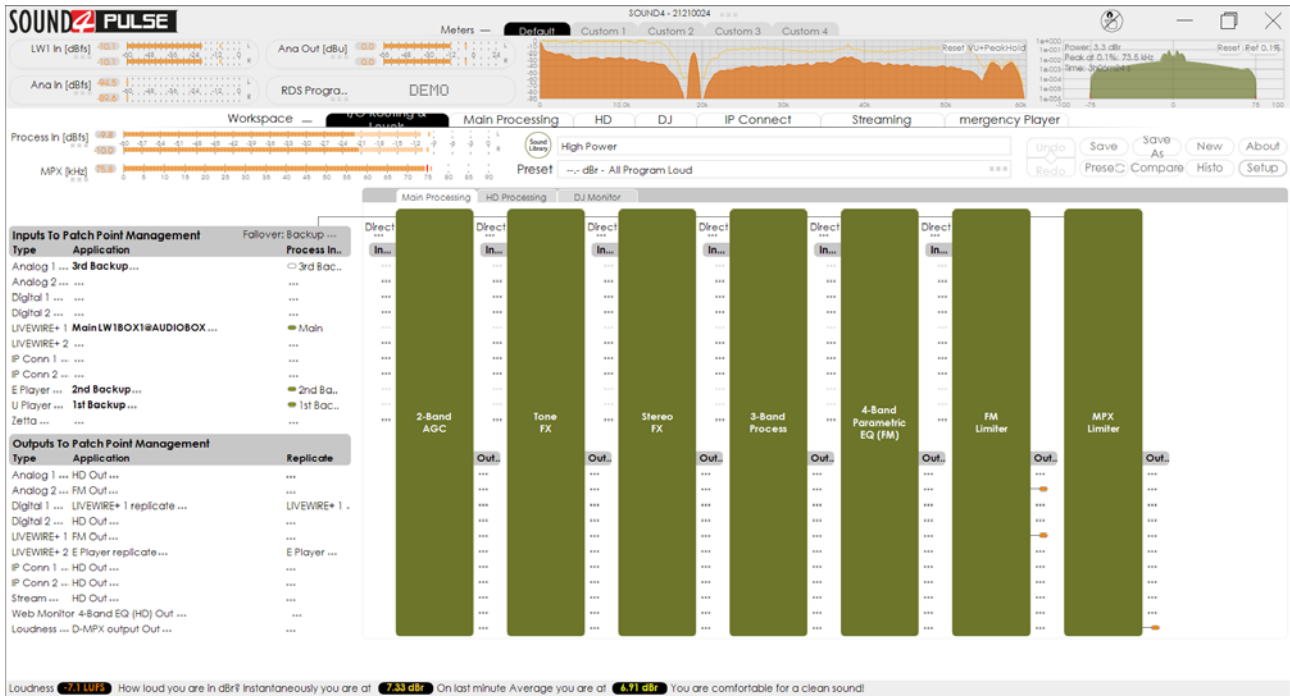

Allows set-up of the Inputs and Outputs to be made. You can change the Application and Preset Input of each Input and Output by pressing on the relevant menu option.

The management section is placed on the left part of the screen and is divided in two parts - Inputs to Patch Point Management (1) and Outputs to Patch Point Management (2). Both sections allow application of the inputs and outputs to be assigned as well as their range and levels.

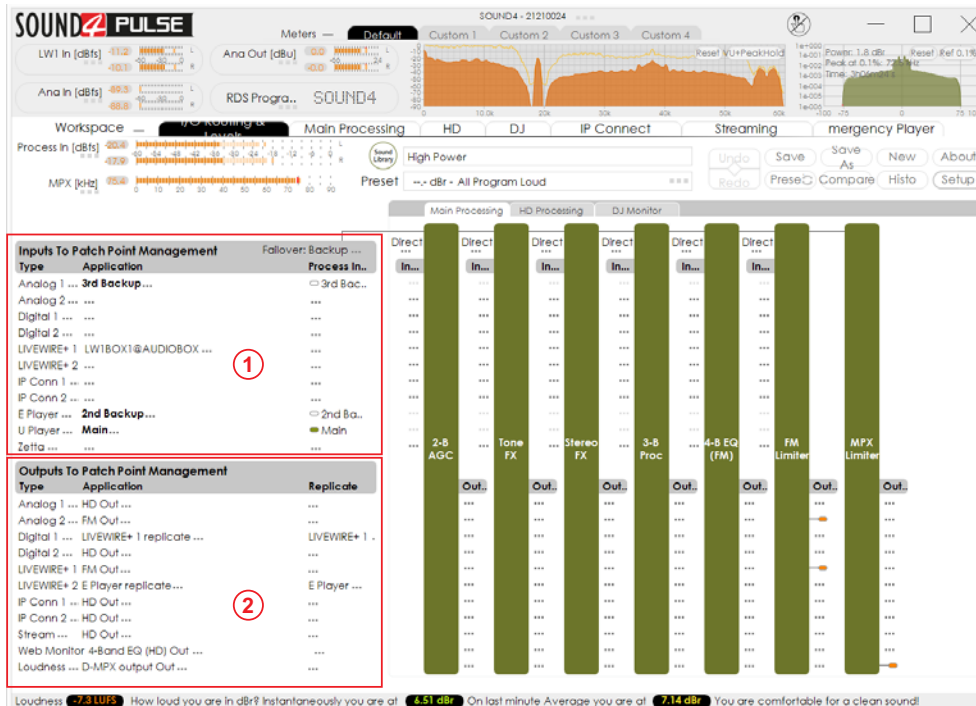

The set-up process is different for each parameter, but quite simplified and explained in details below:

Inputs Set-up

1. Click on the name of the desired Input;
2. The respective set-up window will appear. Apply the desired settings and press [X]. The changes will be automatically saved.

For the Analog inputs - set Input Range and Input full-scale Reference:

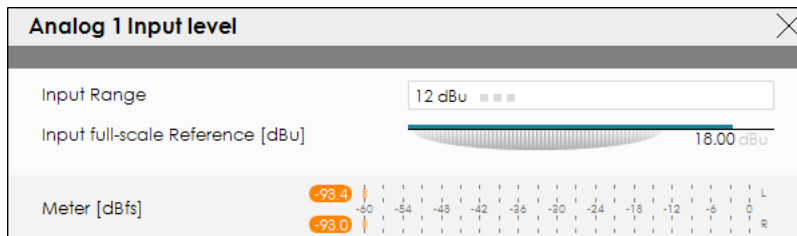

For the Digital Inputs, Emergency Player, Zetta Player and the Emergency URL Player Input level - set Input full-scale Reference:

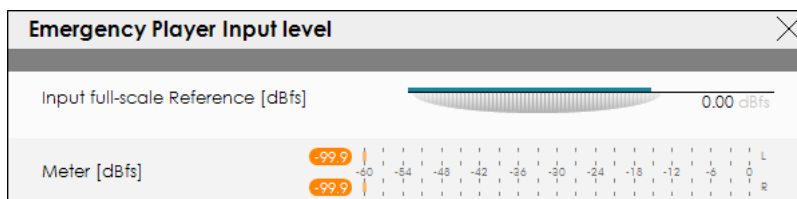
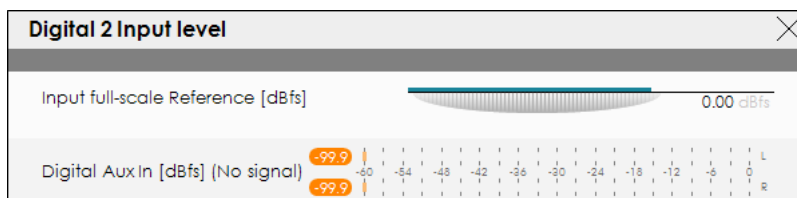

For the LIVEWIRE inputs - Enable the input by selecting [ON] with a click, then select LAN mode by clicking on [LIVEWIRE ...], number of channels, From/To Source, Primary Source Name, Local Name, Stream mode, Status and Input full-scale Reference:

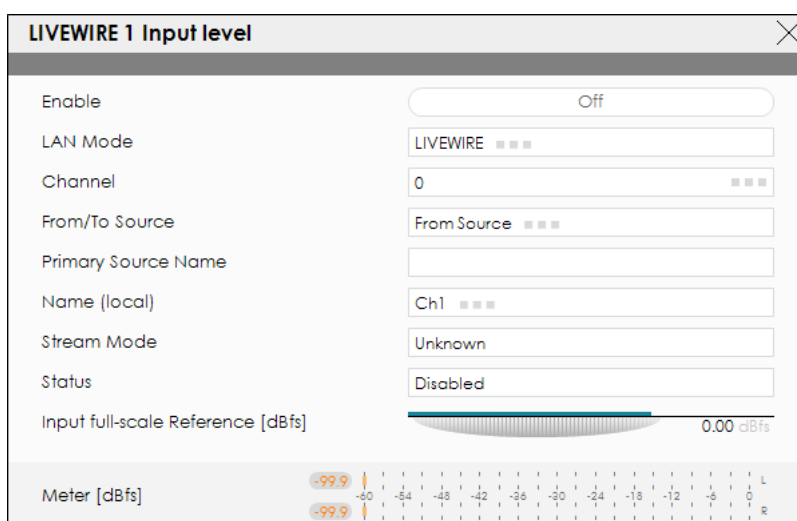

3. To assign application of the Input, press on the Process Input label or on ... (if such is not assigned to the input);

- A window with the possible options will appear. Click on the one preferred and the window will disappear, automatically assigning the chosen value.

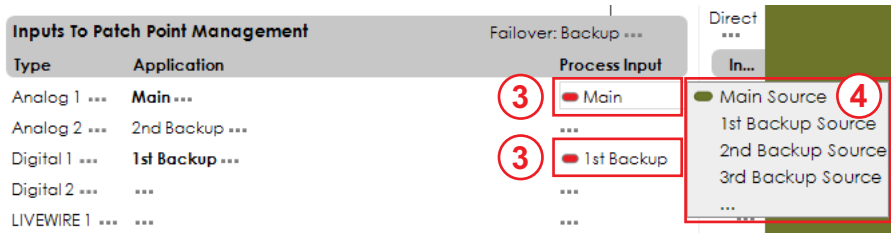

Outputs Set-up

- Click on the name of the desired Output;
- The respective set-up window will appear. Apply the desired settings and press [X]. The changes will be automatically saved.

For the Analog Outputs - set Output range, select Application from the drop-down menu, then Auto De-emphasis and Output full-scale Reference:

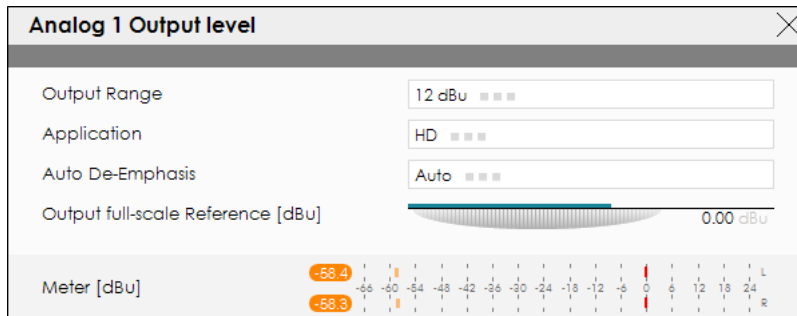

For the Digital Output level - select Application from the drop-down menu, then Auto De-Emphasis, Sampling Frequency, AES In Sync, AES 2 In Sync, Use External Word clock, Ext. Video Sync and Output full-scale Reference:

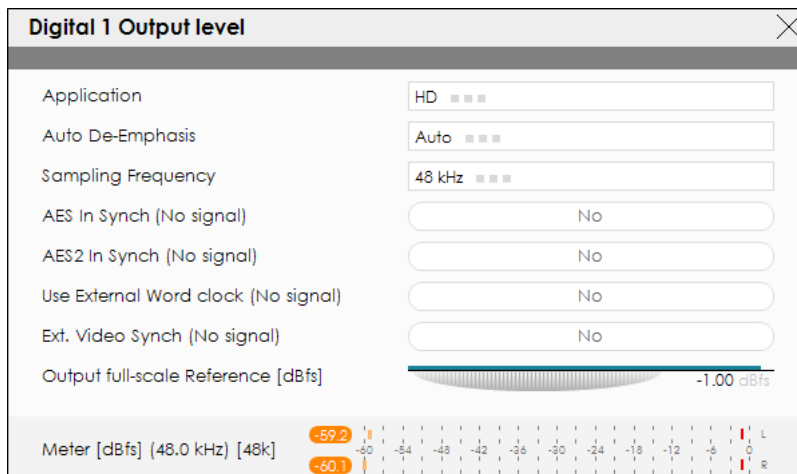

For the LIVEWIRE Output level - Enable the output by selecting [ON] with a click, select profile by clicking on [Livewire Live Audio...], number of channels, Name, Label, Status, Configure GPO, select Application from the drop-down menu, then Auto De-Emphasis, and Output full-scale Reference:

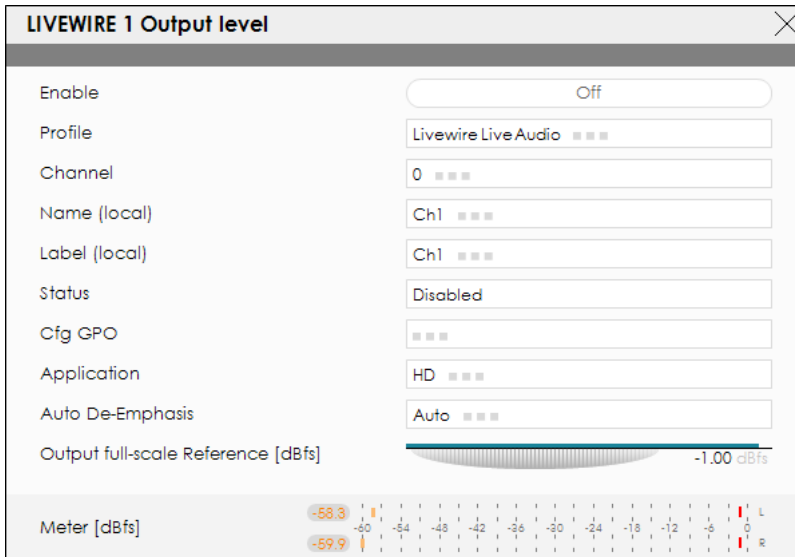

For the IP Connect level, Stream Output level and WebMon - select Application from the drop-down menu, then Auto De-emphasis and Output full-scale Reference:

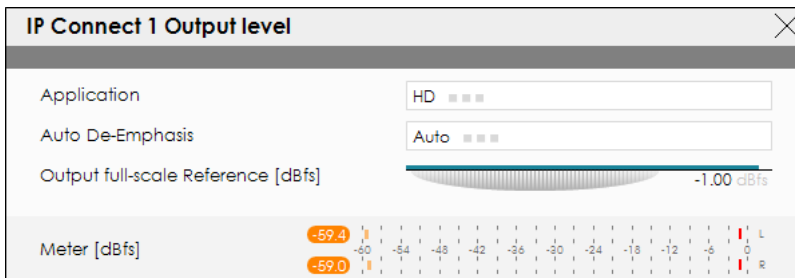

To set up Loudness Measurement select Application from drop down menu and set the integration time and all the necessary parameters as needed.

3. To assign Replicate of the Output, press on the Replicate label or on ... (if such is not assigned to the output);
4. A window with the possible options will appear. Click on the one preferred and the window will disappear, automatically assigning the value chosen.

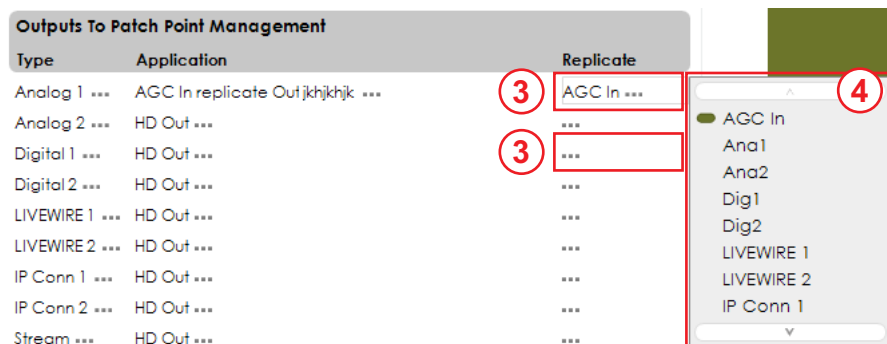

HD PROCESSING

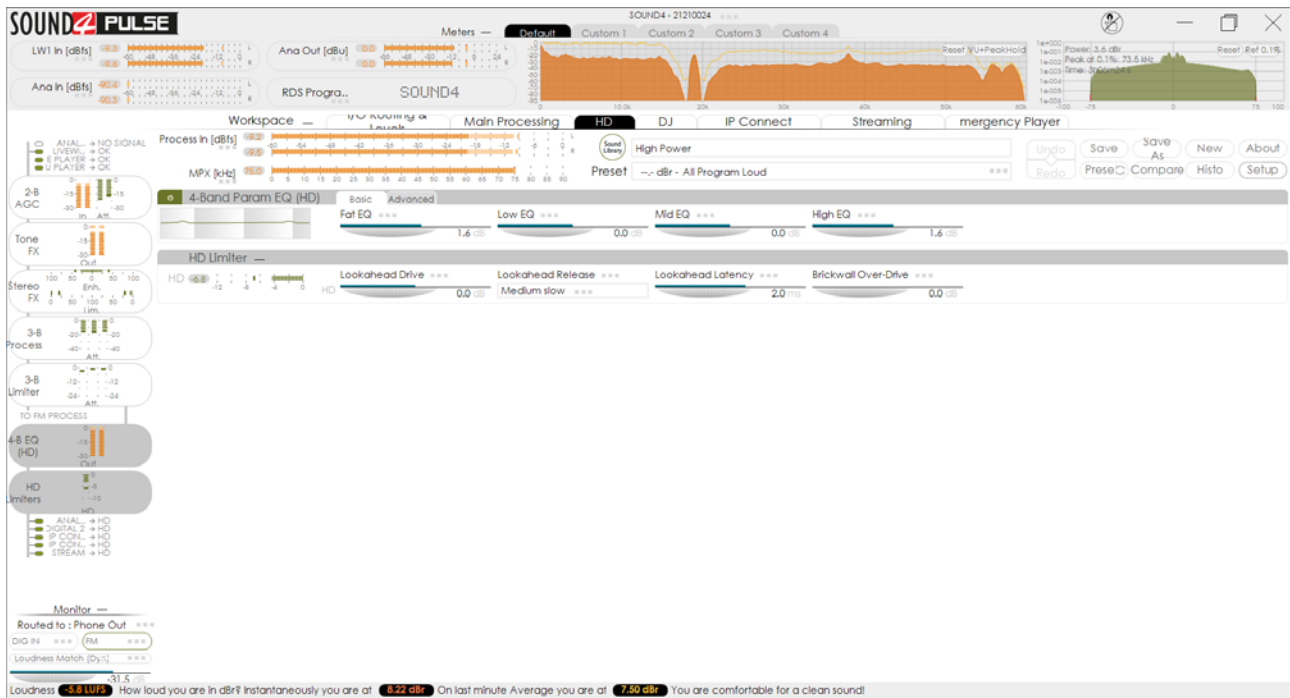

Just as the Main Processing, the HD Processing is divided to Basic and Advance. Both options can be generally turned ON or OFF by pressing the button placed in front of the name.

Basic



Advanced

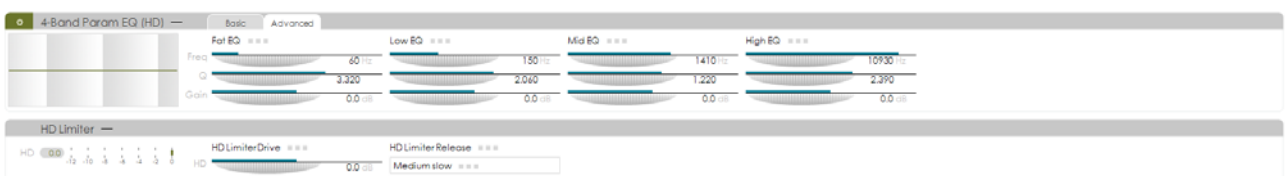

We recommend you to pay special attention when adjustments to this section are made, as too much level from any of the bands could cause an excessive amount of final limiter activity to this particular range of frequencies. These controls are intended to optimize the overall frequency balance for the HD channel.

Fat EQ – represents the lowest band, and is very useful for eliminating problematic rumble or hum frequencies, or making the low end “punch” pop through.

Low EQ – used for cutting some of the typical low midrange “mud” caused by the proximity effect or to help enhance the classic sound.

Mid EQ – adds intelligibility and clarity in the critical midrange frequencies.

High EQ – will enhance the top end.

The HD processing uses a look-ahead limiter for peak control. Instead, they It is adjustable by the Final Limiter Drive control. Reducing limiter drive reduces the amount of limiting and makes the sound more open, but this will affect the overall loudness. Increasing the limiter drive will result in more limiting and a louder output, but will affect the dynamics. The HD Limiter Release is also customizable.

IP CONNECT

The screenshot displays the SOUND4 PULSE software interface. At the top, there are several meters for audio levels (LW1 In, Ana Out, Ana In) and a spectrum analyzer. The main area is titled 'IP Connect' and shows configuration options for 'Board IP Setup'. It includes fields for IP Address (172.16.2.130), Public IP (83.99.233.242), and various network settings like DHCP Mode, DNS, and Gateway. There are also sections for Encoder and Decoder status, and a Link Management section. At the bottom, there is a status bar with audio level indicators and a 'Loudness' meter.

Settings buttons

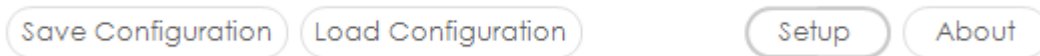

[Save configuration] – Will export the current IP connect configuration so that it could be stored for future references or if need be, reloaded to the device. Select the preferred folder where the file should be stored and then press [OK] to export it.

[Load configuration] – Allows already created configuration to be uploaded to the device. Select the file and then press [OK] to upload it.

[Set-up] – will open the set-up menu. For detailed information on the process, please refer to [“Setup” on page 84](#).

[About] – Will open a window with the following options.

Meters

- depicts the current values of each parameter.

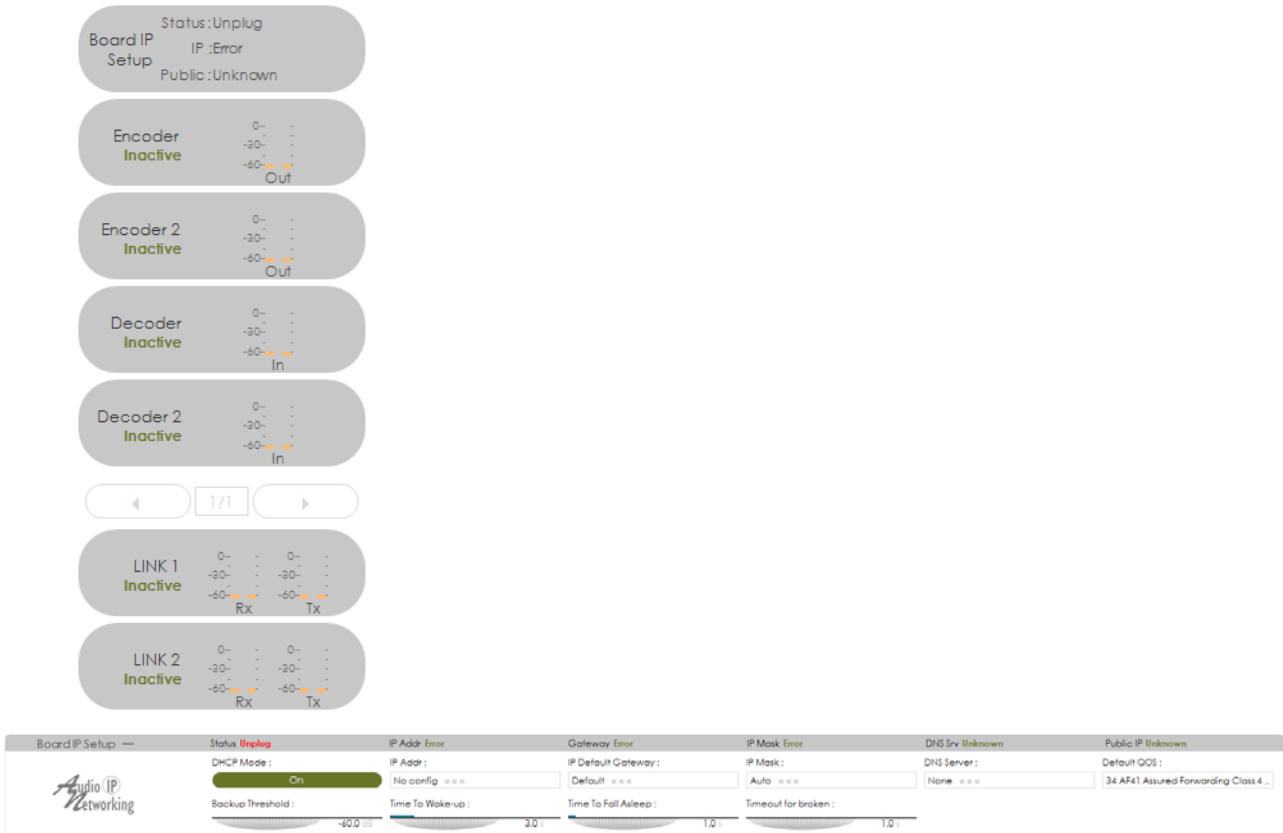

The network addresses could be set manually (static IP) or automatically via a **DHCP Server**. To set static **IP Address**, **IP Default Gateway**, **IP Mask**, **DNS Server** and **Default QCS**, the **DHCP** should be disabled.

DHCP Mode – In order for the built-in DHCP client to be activated, the function should be enabled.

Backup Threshold – if the level of the Audio fails below this threshold it will immediately switch the backup player on.

You can also customize as per your requirements the **Time to Wake-up**, **Time to Fall Asleep** and **Timeout** for broken settings.

STREAMING

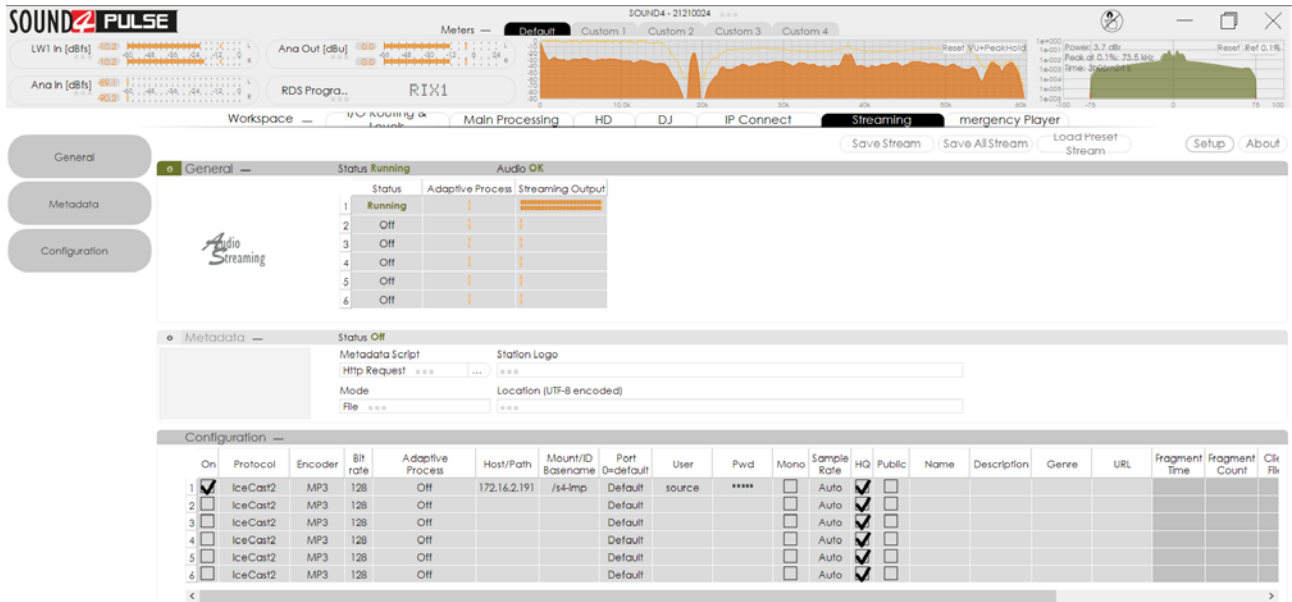

Loudness **4.3 LUFS** How loud you are in dB? Instantaneously you are at **7.42 dB** On last minute Average you are at **7.82 dB** You are comfortable for a clean sound!

Allows all the mandatory settings to the Streamer option to be applied. The tab is visually divided into three parts - General, Metadata and Configuration.

[Save Stream] – Saves the applied settings.

[Save All Stream] – Exports the list of streams.

[Load Preset Stream] – Will load an already set stream preset.

General – depicts the current status of each stream, if enabled.

Metadata – A double click with the mouse cursor on the ON box will enable the option. The following script options are available via the interactive drop down menu: Http Request, Jazler, MasterControl, Nexgen Audio Sense, WinMedia, Zetta.

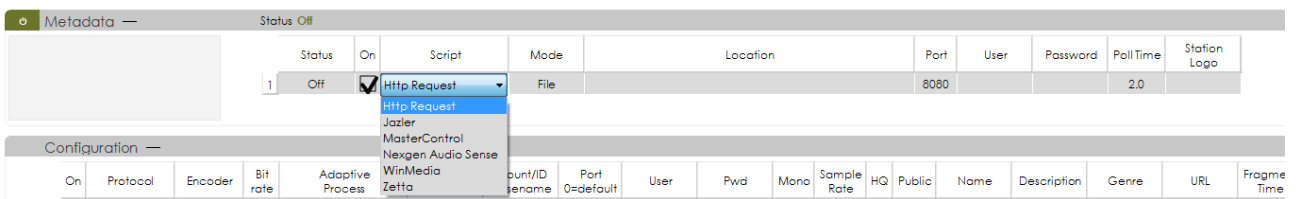

Configuration – Combination of multiple parameters. A double click with the mouse cursor on the ON box will enable the currently selected streamer.

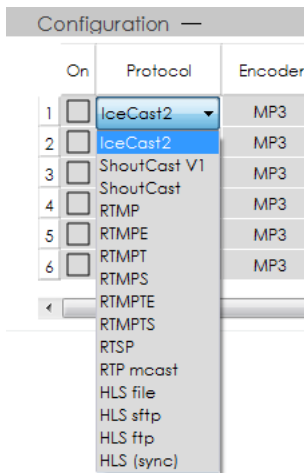

The following protocols are available from the “Protocol” drop-down menu:

IceCast2, ShoutCast V1, ShoutCast, RTMP, RTMPE, RTMPT, RTMPS, RTMPTE, RTMPTS, RTSP, RTP mcast, HLS file, HLS sftp, HLS ftp, HLS (sync).

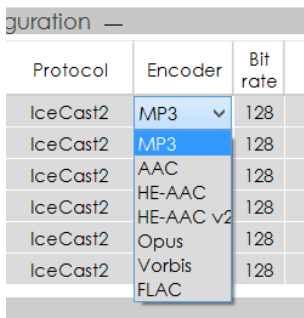

The following encoder options are available from the “Encoder” drop-down menu:

MP3, AAC, HE-AAC, HE-AAC v2, Opus, Vorbis, FLAC.

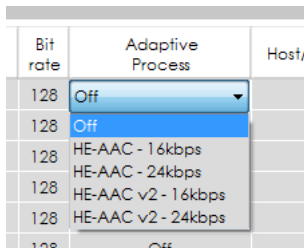

The following options are available from the “Adaptive Process” drop-down menu:

Off, HE-AAC - 16kbps, HE-AAC - 24kbps, HE-AAC v2 - 16kbps, HE-AAC v2 - 24kbps

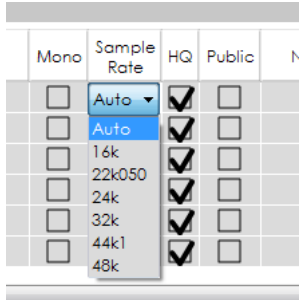

Sample rates available from the “Sample Rate” drop-down menu:

Auto, 16k, 22k050, 24k, 32k, 44k1, 48k.

EMERGENCY PLAYER

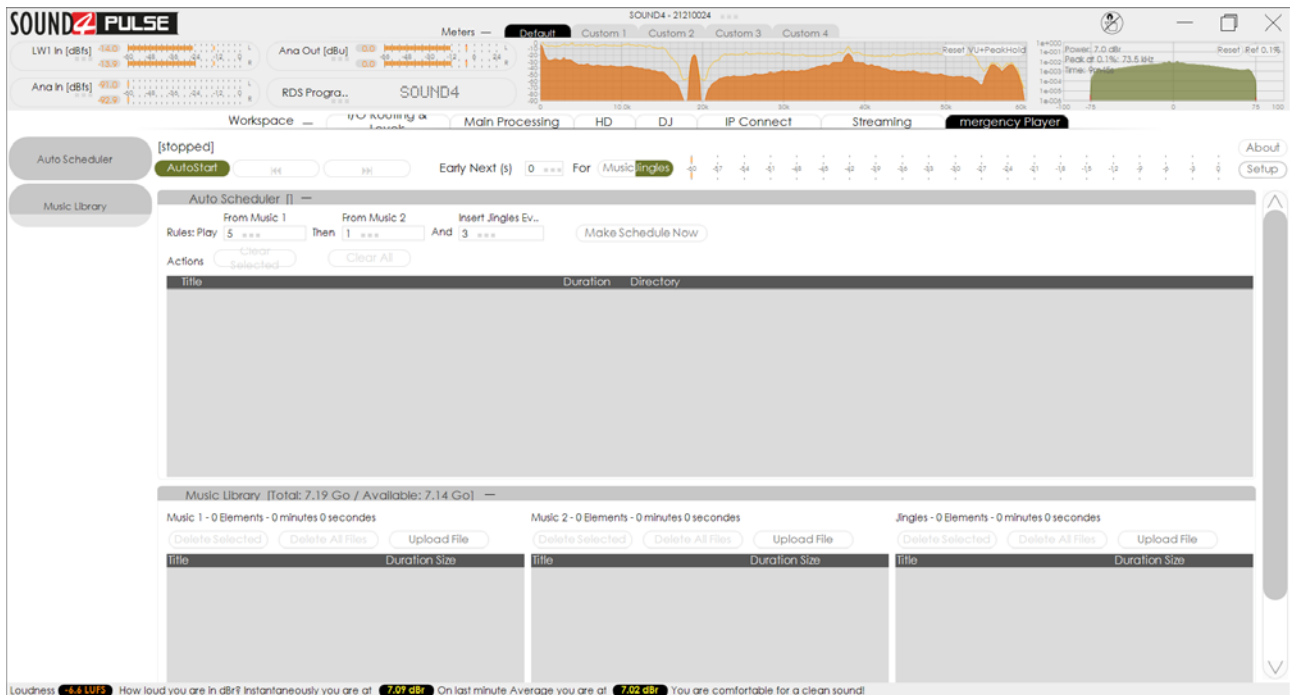

Allows all the needed settings to the Emergency player to be applied. The tab is visually divided into two parts - Auto Scheduler and Music Library.

This is how the player works - There are three directories that allow jingles and music of two different genres to be uploaded (**Music 1** and **Music 2**). Once the files are uploaded, you just need to define the parameters under which a jingle will be played (after how many songs). The rules are explained in details below.

The player can be manually started or automatically by pressing [Auto Start]. Once the option is enabled, you will have at your disposal the controls for music playback, as well as interactive levels indicators and the **Early Next** option.

Early Next – The currently played song will be gradually mixed with the next one.



The Auto Scheduler allows you to define the parameters under which a scheduler will be created. You can customize the following **Rules**:

From Music 1 – Play - the number of the song to be played first;

From Music 2 – Then - the number of the next song;

Insert Jingles Every – Specifies at what interval a jingle will be played.

The **Music Library** section is divided in three subsections Music 1, Music 2 and Jingles. The supported formats are - MP3, wav and etc.

To add a new MP3 file, follow the instructions below:

1. Press [Upload file];
2. Go to the directory where the files are stored;
3. Select the desired file and press [Upload];
4. Wait until the file is uploaded.

Based on the files loaded in the Music Library and the Auto Scheduler Rules, a schedule can be created by pressing [Make Schedule Now].

[Delete Selected] – will delete the selected file;

[Delete All Files] – will delete the entire list of files.

HOW A PRESET CAN BE MADE

The SOUND4 PULSE has a set of several factory presets. In order for a preset to be selected/used, the [Load] button should be pressed (the active preset is illuminated in green). Each of the factory presets can be used as a basis for creation of new user-defined preset. Once you are satisfied with the result all the changes could be saved.

IT IS RECOMMENDED:

1. The user presets to be created prior to the installation of the SOUND4 in the broadcasting chain. Otherwise, any drastic changed of the audio quality and enhancements will be audible for the listeners.
2. Unless the new preset is created by a qualified/experienced broadcaster, it is recommended that no general changes to the base preset (if such is used) to be applied, as this can lead to unwanted signal distortion.

The procedure is quite simple. Below you will find a step-by-step description of the process:

1. Press on [Preset] and choose a factory preset that you would like to use for a basis of the new one. It will be automatically uploaded in the device;

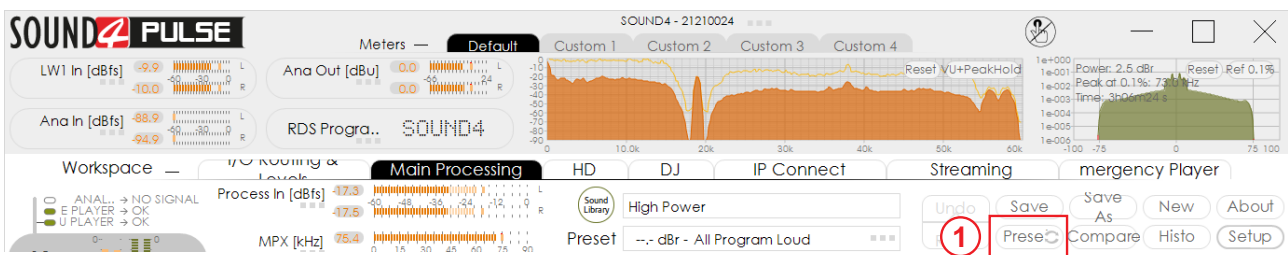

2. Modify the parameters that you think would improve the enhancement of your signal and will make your station's sound unique;
3. Once you are satisfied with the result, go back to the Presets page. You will notice that after the currently selected preset, a the following message indicating that some changes are being made will appear:

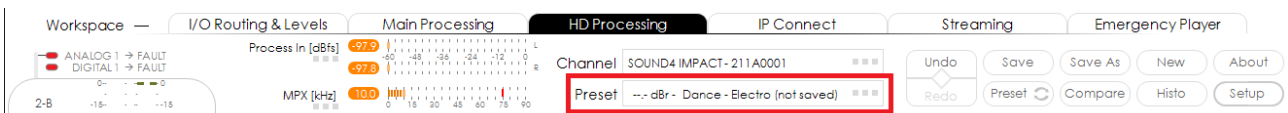

4. In order to save the changes select one of the user presets and press the [Save as] button.

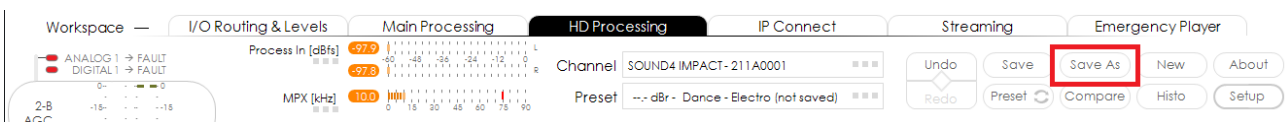

5. The following window will appear:

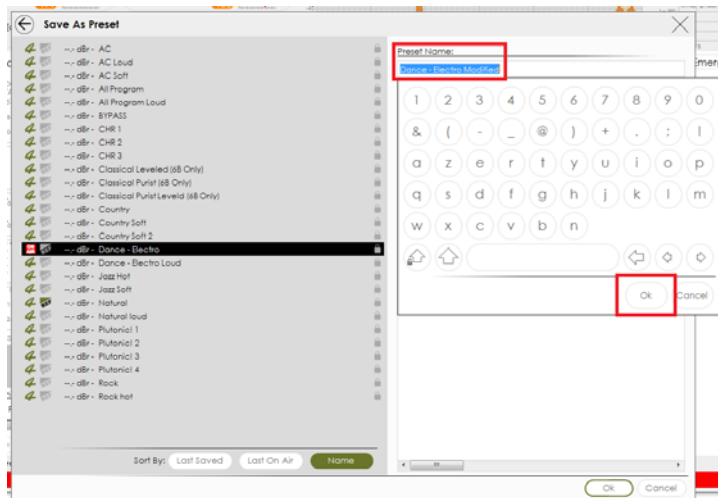

Specify the preset name and press [OK]. When specifying the name, you can either use the interactive keyboard, or write in the field directly.

6. The newly created preset will be automatically chosen as 'active preset'.

Preset Security

As many of the stations prefer to use the services of qualified personnel when creating the perfect preset, the SOUND4 PULSE supports the function the newly created preset to be secured. Menu path **Presets > Preset Security**. The following options are available:

[Set password] – the preset will be locked with a key known only by the creator. Thus, only users familiar with it would be able to import it into devices different than the one used for the purposes of creation;

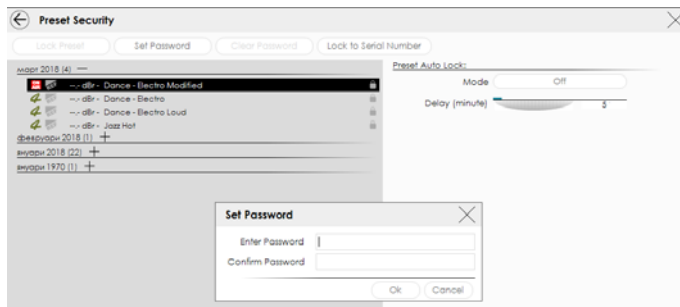

[Lock to Serial Number] – you can specify the serial number of the device on which the preset can be used. Only the unit with this serial number will be able to import this preset.

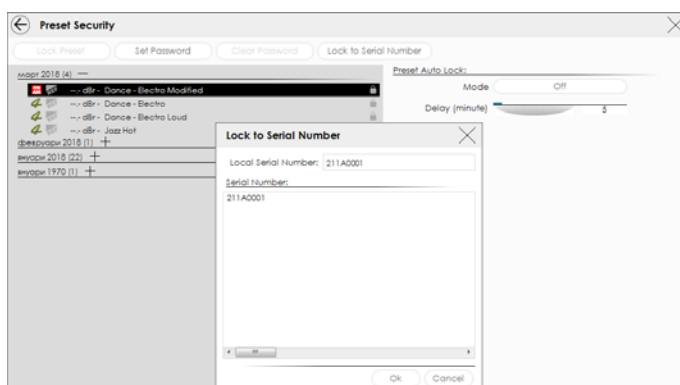

Depending on your preferences, both, one or none of the above explained options can be used.

Preset Export

In order for a user preset to be exported the following procedure should be completed:

1. Open the [Preset] menu;
2. Select the preset to be exported and then press the [Export] button.
3. Select directory and confirm with [OK] to save the file on your computer.
4. Once the process is completed, the following message will appear:

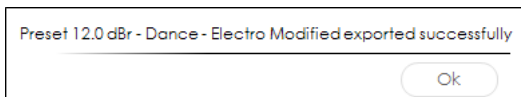

Presets Import

1. Open the [Preset] menu;
2. Press the [Import] button;
3. Select the .s4imp file of the preset to be imported and press [OK] to confirm;
4. Once the process is completed, the following message will appear:

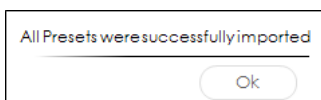

Presets Delete

1. Open the [Preset] menu;
2. Select the preset to be deleted and then press the [Delete] button;
3. Confirm that you want to delete the preset:

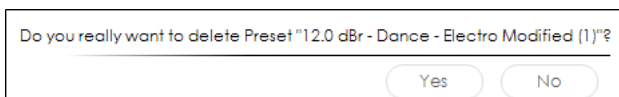

4. The preset will be deleted.

SETUP

The menu is divided into several sections - *Settings*, *IP Connect*, *Advanced*. Each section includes several subsections, thus allowing complete set-up of the device.

Settings

General

Allows set-up of the following parameters - Channel name, Display, Application Auto Exit, Preset Security, Process Autolock, Audio IP Autolock and Streaming Autolock.

The screenshot displays the 'SETUP' application window with the 'General' settings page selected. The interface is organized into several sections:

- CHANNEL NAME**: Includes fields for 'Name Edit' (SOUND4 IMPACT- 211A0001), 'AES67/Livewire+ host name' (IMPACT-A67-211A0), and 'IP Connect host name' (IMPACT-IP-211A00).
- DISPLAY**: Includes 'Themes' (SOUND4 (Default)), 'Language' (English), 'Show Bubble Values' (On), 'Show Virtual Keyboard' (On), 'Virtual Keyboard Type' (Azerty), and 'VU Meters Speed' (25%).
- APPLICATION AUTO EXIT**: Includes 'Mode' (Off) and 'Delay (minute)' (5).
- PRESET SECURITY**: Includes 'Auto Lock' (Off) and 'Delay (minute)' (5).
- PROCESS AUTOLOCK**: Includes 'Auto Lock' (Off) and 'Delay (minute)' (5).
- AUDIO IP AUTOLOCK**: Includes 'Auto Lock' (Off) and 'Delay (minute)' (5).
- STREAMING AUTOLOCK**: Includes 'Auto Lock' (Off) and 'Delay (minute)' (5).

A left-hand sidebar lists various settings categories, with 'General' currently selected and highlighted.

NOTE that the Software provides two types of themes, depending on the user's requirements - black and grey.

Users

Allows set-up of the user accounts. Only the users acquaint with the admin credentials will be allowed to apply changes to the device's parameters and settings.

The screenshot shows the 'SETUP' menu with 'Print Settings' selected. The 'Users' option is highlighted in the left sidebar. The main area displays a 'Users List' table with columns for 'Activate', 'Name', 'Type', 'Remote Password', and 'Front Panel PIN code'. Two users are listed: 'admin' (Super Administrator) and 'PresetSharing' (Preset Sharing). Below the table, the 'Current User Info' section shows the user type as 'Super Administrator'.

Activate	Name	Type	Remote Password	Front Panel PIN code
<input checked="" type="checkbox"/>	admin	Super Administrator	ok	none
<input type="checkbox"/>	PresetSharing	Preset Sharing	none	----

Current User Info: —
 Type: Super Administrator

Preset Settings

All Preset related settings are gathered in this section, thus allowing set-up of the Process General gate, Input High-Pass Filter, Output High-Pass Filter, Matrixed mode, 2-Band AGC Frequency, 3-Band Processor Frequencies, 3-Band Limiter Frequencies.

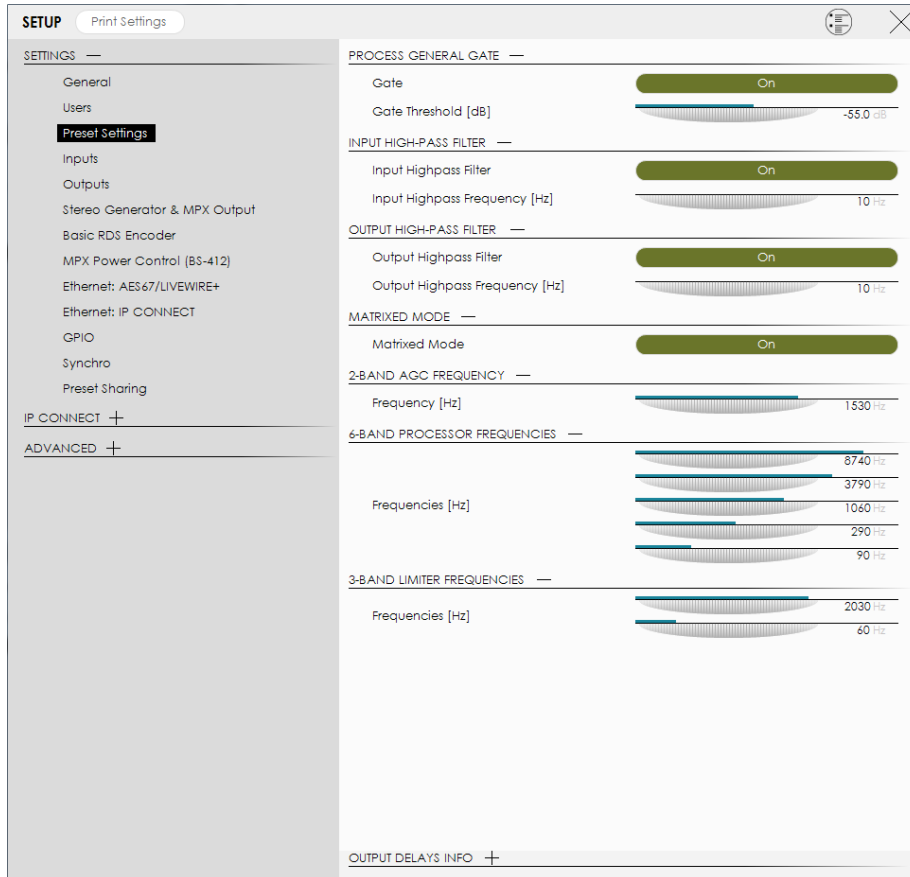

The Output delays info is also available on the bottom of the page, upon pressing the + button placed next to the name of the option.

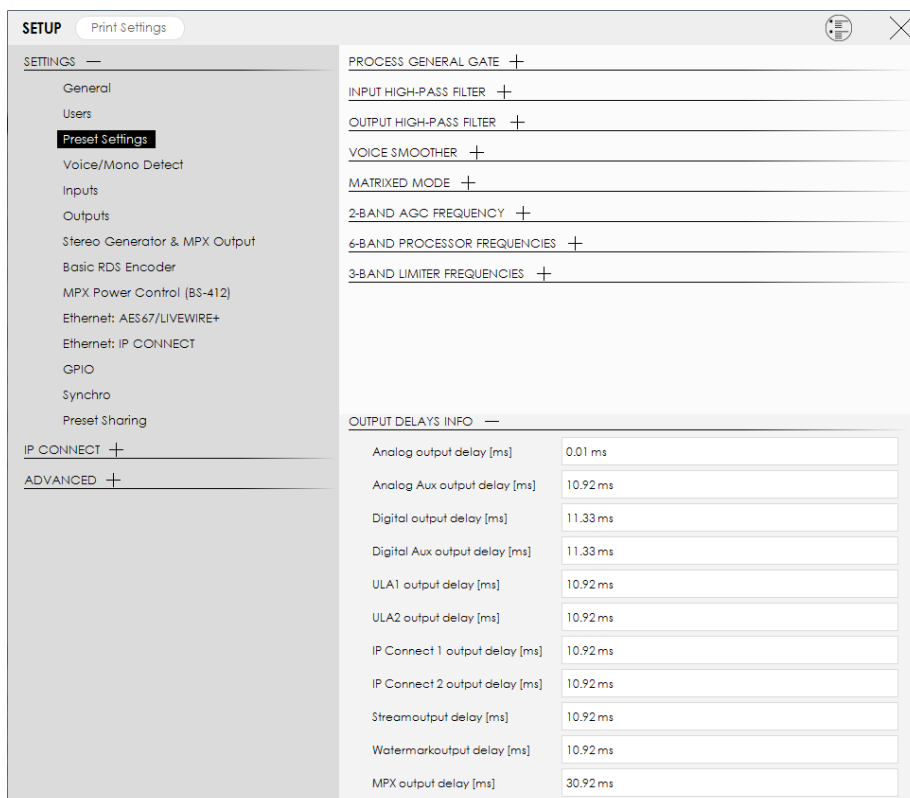

Inputs

This section allows you to customize all the Input settings as per your requirements. Depicted below are the available menu options:

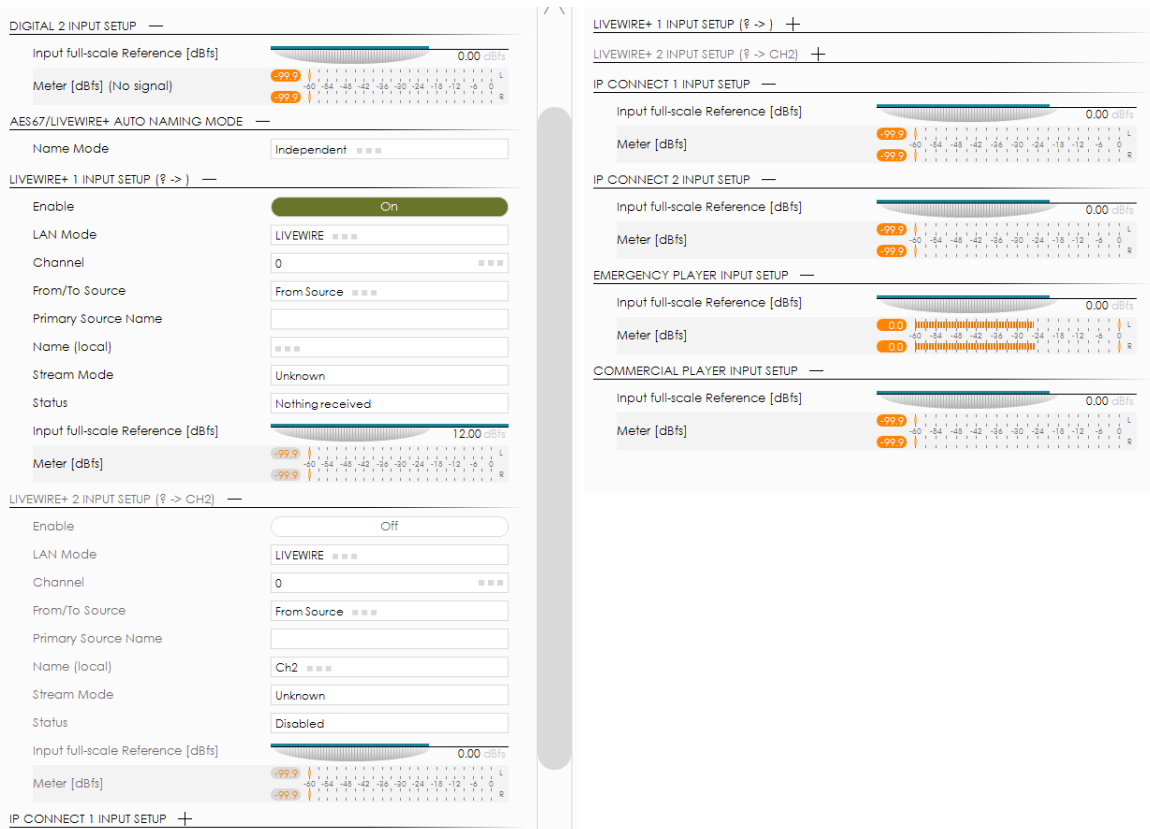
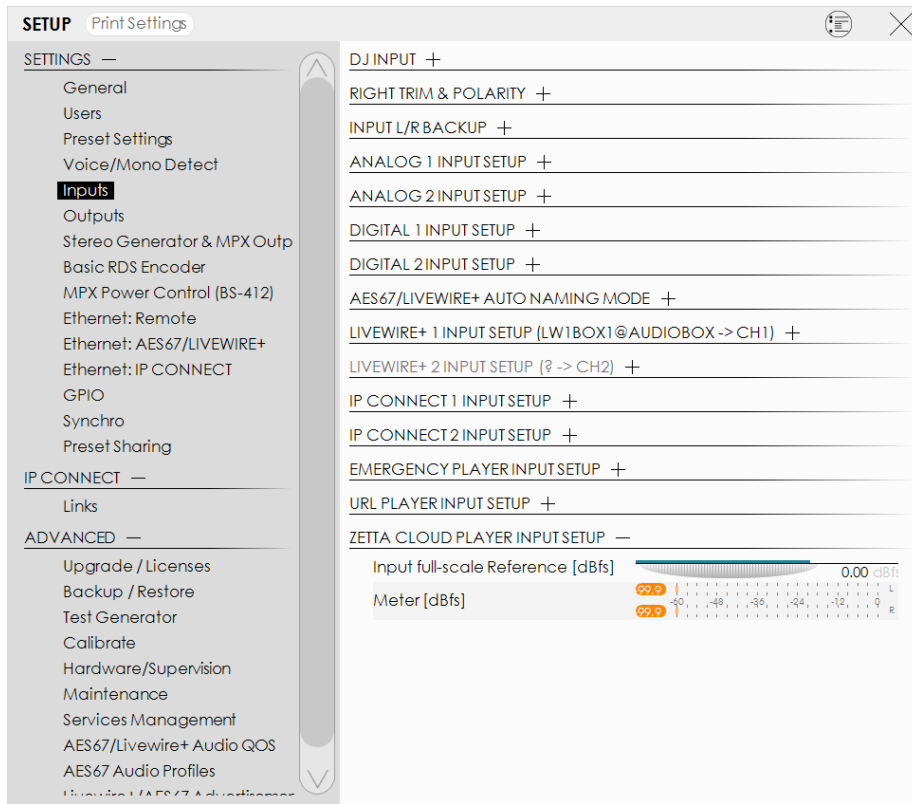

Outputs

This section allows you to customize all the Output settings as per your requirements. Depicted below are the available menu options:

SETUP Print Settings

SETTINGS —

- General
- Users
- Preset Settings
- Voice/Mono Detect
- Inputs
- Outputs**
- Stereo Generator & MPX Outp
- Basic RDS Encoder
- MPX Power Control (BS-412)
- Ethernet: Remote
- Ethernet: AES67/LIVEWIRE+
- Ethernet: IP CONNECT
- GPIO
- Synchro
- Preset Sharing

IP CONNECT —

- Links

ADVANCED —

- Upgrade / Licenses
- Backup / Restore
- Test Generator
- Calibrate
- Hardware/Supervision
- Maintenance
- Services Management
- AES67/Livewire+ Audio QOS
- AES67 Audio Profiles
- Livewire+ AES67 Audio Profiles

ANALOG 1 OUTPUT SETUP +

ANALOG 2 OUTPUT SETUP +

DIGITAL 1 OUTPUT SETUP +

DIGITAL 2 OUTPUT SETUP +

AES67/LIVEWIRE+ AUTO NAMING MODE +

LIVEWIRE+ 1 (FM-> CH1) +

LIVEWIRE+ 2 (E PLAYER REPLICATE-> EPS4BP) +

IP CONNECT 1 OUTPUT SETUP +

IP CONNECT 2 OUTPUT SETUP +

STREAM OUTPUT SETUP +

WEB MONITOR OUTPUT SETUP —

Application: 4-Band EQ (HD) ■■■

Auto De-Emphasis: Auto ■■■

Output full-scale Reference [dB]:

Meter [dBfs]:

PHONE OUTPUT SETUP +

ANALOG 2 OUTPUT SETUP +

DIGITAL 1 OUTPUT SETUP +

DIGITAL 2 OUTPUT SETUP —

Application: HD ■■■

Auto De-Emphasis: Auto ■■■

Sampling Frequency: 48 kHz ■■■

AES In Synch (No signal): No

AES2 In Synch (No signal): No

Use External Word clock (No signal): No

Ext. Video Synch (No signal): No

Output full-scale Reference [dBfs]:

Meter [dBfs] [48.0 kHz] [48k]:

AES67/LIVEWIRE+ AUTO NAMING MODE —

Name Mode: Independent ■■■

Label Mode: Independent ■■■

LIVEWIRE 1 (HD-> ?) —

Enable: Off

Profile: Livewire Live Audio ■■■

Channel: 0 ■■■

Name (local): Ch1 ■■■

Label (local): Ch1 ■■■

Cfg GPO: ■■■

Application: HD ■■■

Auto De-Emphasis: Auto ■■■

Output full-scale Reference [dBfs]:

Status: Disabled

Meter [dBfs]:

LIVEWIRE 2 (HD-> ?) +

AES67/LIVEWIRE+ AUTO NAMING MODE +

LIVEWIRE 1 (HD-> ?) +

Enable: Off

Profile: Livewire Live Audio ■■■

Channel: 0 ■■■

Name (local): Ch2 ■■■

Label (local): Ch2 ■■■

Cfg GPO: ■■■

Application: HD ■■■

Auto De-Emphasis: Auto ■■■

Output full-scale Reference [dBfs]:

Status: Disabled

Meter [dBfs]:

LIVEWIRE 2 (HD-> ?) —

IP CONNECT 1 OUTPUT SETUP —

Application: HD ■■■

Auto De-Emphasis: Auto ■■■

Output full-scale Reference [dBfs]:

Meter [dBfs]:

IP CONNECT 2 OUTPUT SETUP —

Application: HD ■■■

Auto De-Emphasis: Auto ■■■

Output full-scale Reference [dBfs]:

Meter [dBfs]:

PHONE OUTPUT SETUP —

Phone Gain [dB]:

Application: HD output ■■■

Phone Auto De-Emphasis: Auto ■■■

Stereo Generator & MPX Output

This section gathers all the mandatory settings applied to the Stereo Generator and MPX Output.

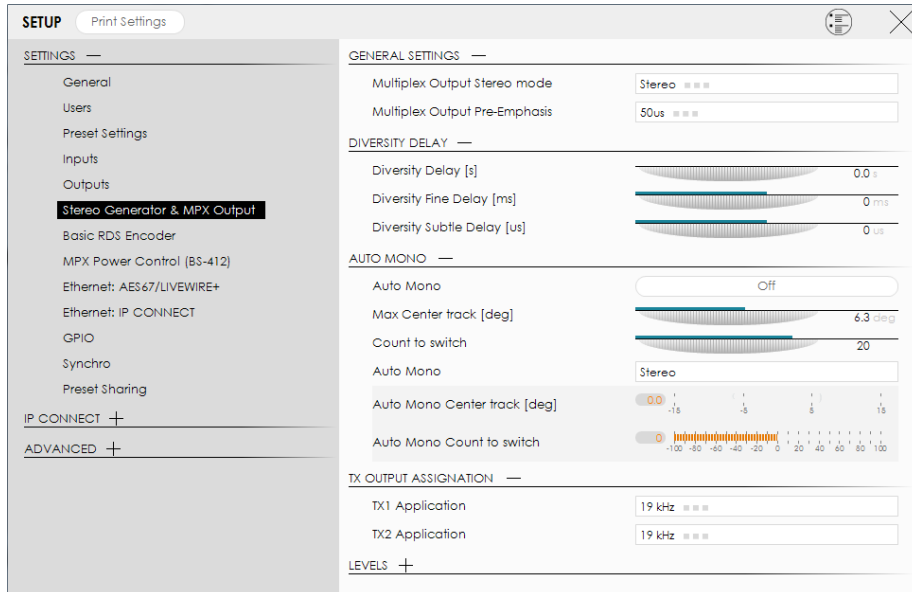

General settings allows control over the Multiplex Stereo mode and the Multiplex Output Pre-Emphasis. Another important option is that via Diversity delay you can set the Delay in seconds, the Fine Delay in ms and the Subtle delay in us.

AUTO MONO subsection is intended to provide you with access to the Auto Mono settings (that can be turned On and Off) and the Count to switch option. As an addition, you can also set the Auto Mono to the desired value. The applied settings will be visualized by the interactive meters.

TX OUTPUT ASSIGNATION - is used to assign the TX1 and TX application as per the user's requirements.

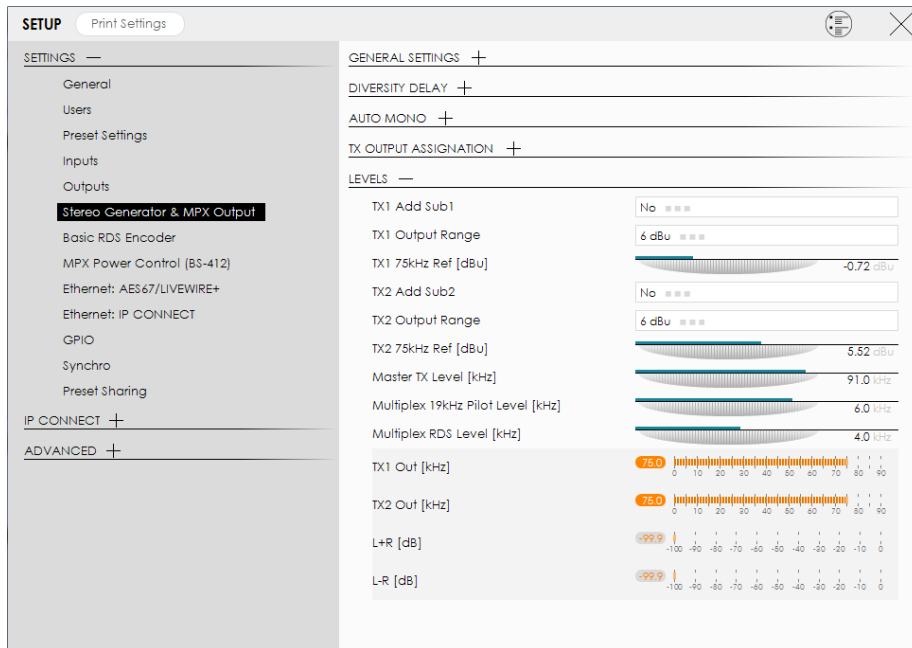

LEVELS - gathers all the additional settings that need to be applied to TX 1 and TX 2 - namely Add Sub, Output Range and 75kHz Ref. You can also use this submenu to set the Master TX level in kHz, the Multiplex 19 kHz Pilot Level and Multiplex RDS level. As an addition, the applied settings will be visualized by the interactive meters.

Basic RDS Encoder – General settings

All the mandatory settings to be applied to the basic RDS/RBDS encoder incorporated in the device are available in this subsection of the SETUP menu.

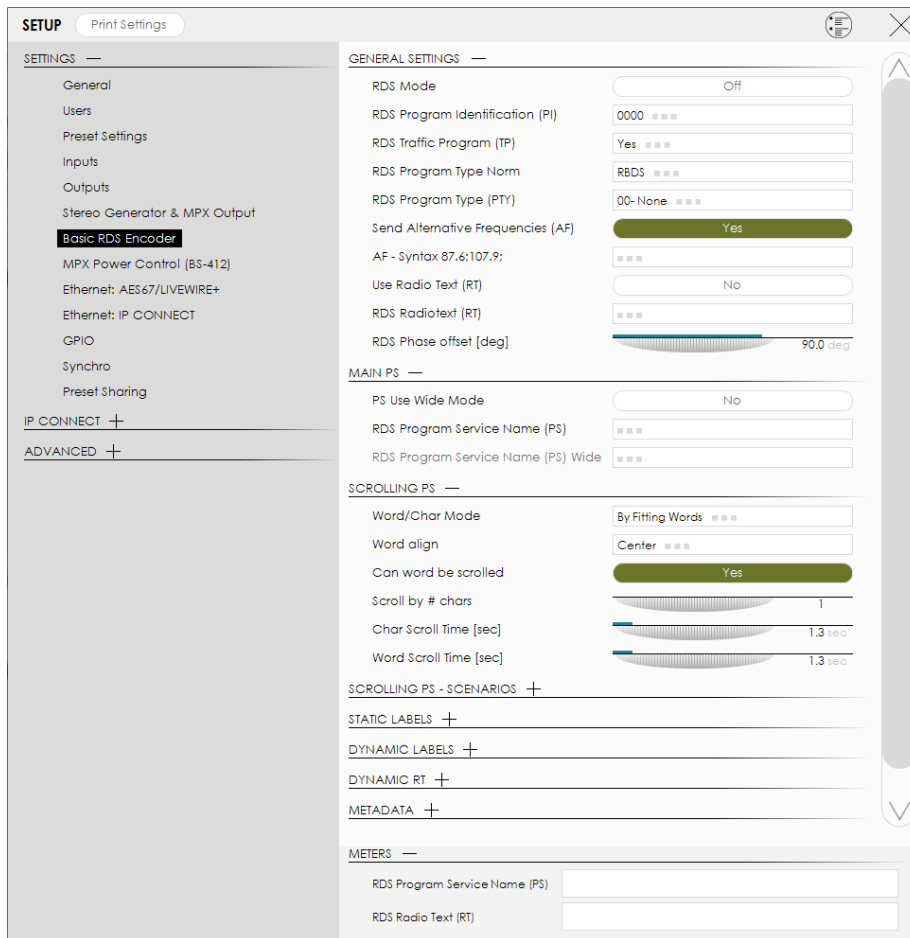

RDS Mode – can be turned [On] or [Off].

RDS Program Identification (PI) – The PI code is your station’s ‘digital address’. It is a hexadecimal code that is assigned by an appropriate broadcasting authority in most countries, but in the United States the PI code is numerically calculated from the station’s call sign.

RDS Traffic Program (TP) – The TP flag identifies the station as one that routinely broadcasts traffic bulletins for motorists as part of its normal, everyday programming. When the TP flag is displayed on the receiver faceplate, the radio is searching for traffic announcements. The radio keeps track of TP stations offering this service to speed up the search-and-switch process.

RDS Program Type Norm – Both the RDS and RBDS standards are supported. Select the proper one from the menu.

RDS Program Type (PTY) – The PTY data flag identifies the station format from a pre-defined categories. Many RDS receivers are able to seek the listener’s preferred format automatically. This means that a car radio can switch from a fading station to a stronger one that carries the same variety of music, though not the very same program, as provided by AF switching. The PTY function of RDS helps a broadcaster catch ‘transient audience’ share. The PTY code is not meant to change from song to song or to accommodate a top-of-the-hour newscast, however.

Send Alternative Frequencies – A network broadcaster, or one with low-power rebroadcast transmitters (translators) to fill holes in his coverage area, can include a list of all frequencies where the identical program can be heard simultaneously. The RDS receiver (particularly the upscale car radio) constantly searches for the best signal that carries the very same program. When a better signal is found, the radio re-tunes with no noticeable interruption. The principal utility of this RDS

function is with European radio networks and US stations with ‘translators.’

AF Syntax 87.6; 107.9 – Defines the range of the AFs.

Use Radio text (RT) – To turn the option ON, press [Yes].

RDS Radio Text (RT) – This is a 64-character block of plain text that the listener can select for visual display on the faceplate of the radio by pressing an INFO button on the receiver. This function is not available on many automobile radios for safety reasons, which has precipitated the frowned-upon practice of scrolling the PS field instead. The **Radio Text** can announce song titles and performers, run special promotions or contests, or broadcast sponsors’ messages.

RDS Phase offset (deg) – Allows Phase offset to be set.

Basic RDS Encoder – Main PS

PS Use Wide Mode – To turn the option ON, press [Yes].

RDS Program Service Name (PS) – This is the station’s “street name” that will appear on the receiver faceplate display. The PS can be up to eight characters in length (including spaces) and can be as simple as the station’s call letters: KWOW or KWOW FM, or a slogan: NEWSTALK or LIVE 95.

RDS Program Service Name (PS) Wide – Allows wider name to be set.

Basic RDS Encoder – Scrolling PS - Scenarios

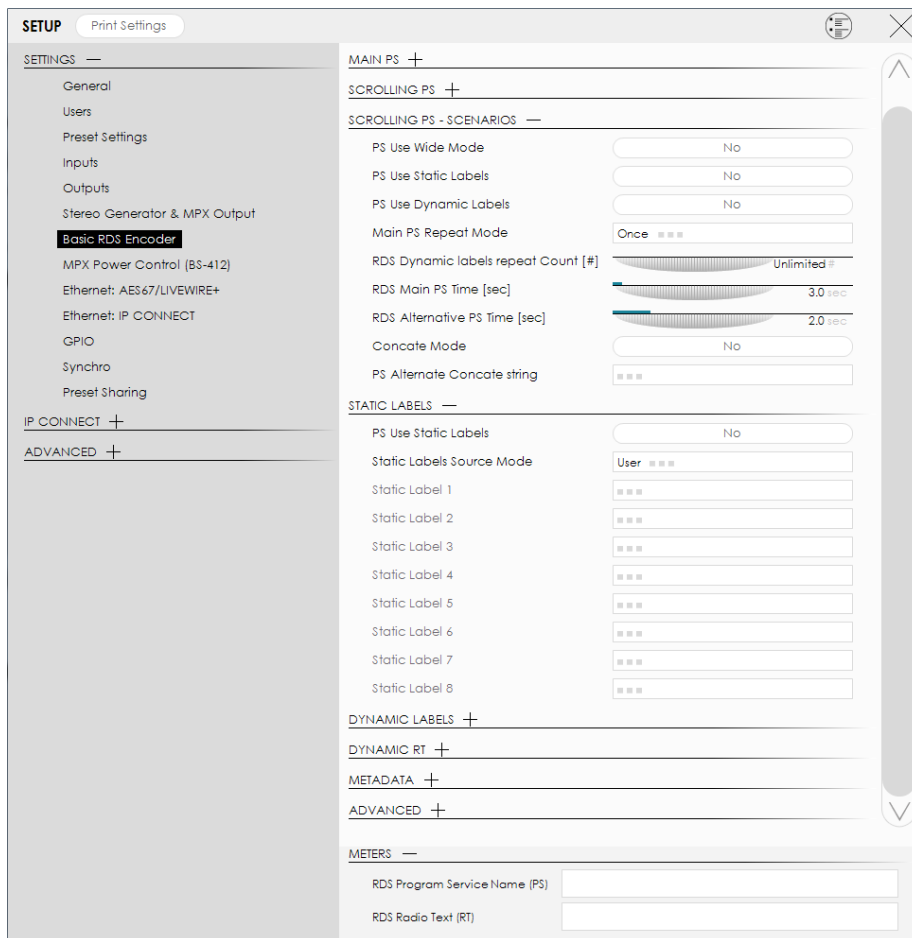

PS Use Wide Mode – To turn the option ON, press [Yes].

PS Use Static Labels – To turn the option ON, press [Yes].

PS Use Dynamic Labels – To turn the option ON, press [Yes].

Main PS Repeat Mode – Select one of the following options: Once, Every Two Labels, Every Three Labels and Never.

RDS Dynamic Labels repeat Count [#] – Set the repeat count number via the interactive slider.

RDS Main PS Time [sec] – Set the Main PS time via the interactive slider.

RDS Alternative PS Time [sec] – Set the Alternative PS Time via the interactive slider.

Concat Mode – To turn the option ON, press [Yes].

PS Alternative Concat string – set the Concat string.

Basic RDS Encoder – Static and Dynamic Labels

PS Use Static/Dynamic Labels – To turn the option ON, press [Yes].

Static Labels Source Mode – Select the desired mode - User or File.

Static/Dynamic Label 1 to 8 – Specify Static/Dynamic label

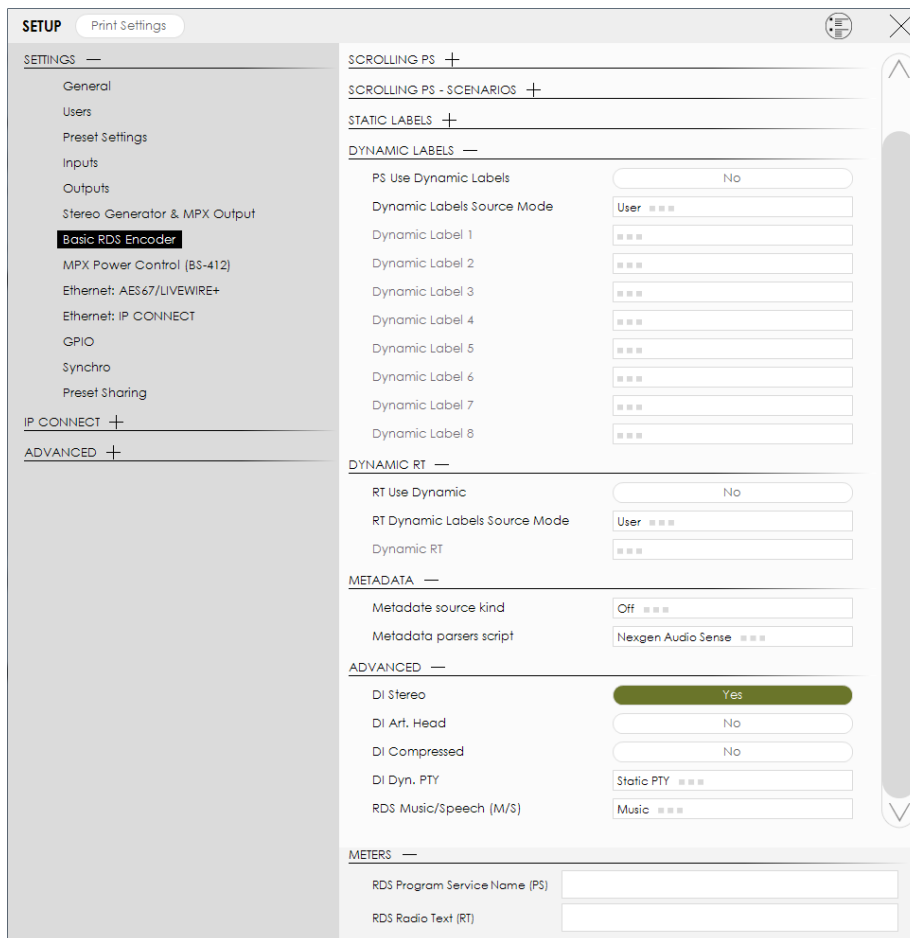

Basic RDS Encoder – Dynamic RT

RT Use Dynamic – To turn the option ON, press [Yes].

RT Dynamic Labels Source Mode – Select the desired mode - User or File.

Dynamic RT - Specify Dynamic RT

Basic RDS Encoder – METADATA

Metadata source kind – Select the desired option - Off, File/URL, TCP Server

Metadata parsers script – Select one of the available automation softwares.

Basic RDS Encoder – Advanced

DI Stereo – To turn the option ON, press [Yes].

DI Art. Head – To turn the option ON, press [Yes].

DI Compressed – To turn the option ON, press [Yes].

DI Dyn. PTY – Select one of the available options - Static PTY, Dynamic PTY.

RDS Music/Speech (M/S) – This flag simply indicates whether music or speech is the primary broadcast programming. Select the appropriate value.

Basic RDS Encoder – Meters

Will depict the current RDS Program Service Name (PS) and RDS Radio Text (RT).

MPX Power Control (BS-412)

Limits the MPX Power as per the ITU BS412 directive. The BS412 standard states that the integrated MPX power in any arbitrary 60-second time period cannot exceed the average power of the sinewave that produced ± 19 kHz carrier deviation. Meaning that you must not exceed the total integrated power limit over the following 60 seconds. The authorities in each country have set different parameters that should be observed. It is recommended your local authorization to be checked.

For your convenience, the option can be generally turned [Off] or [On]. The Meters sections depicts the current status of the Predic PWR, Norm PWR, Integration Time and PWR Red.

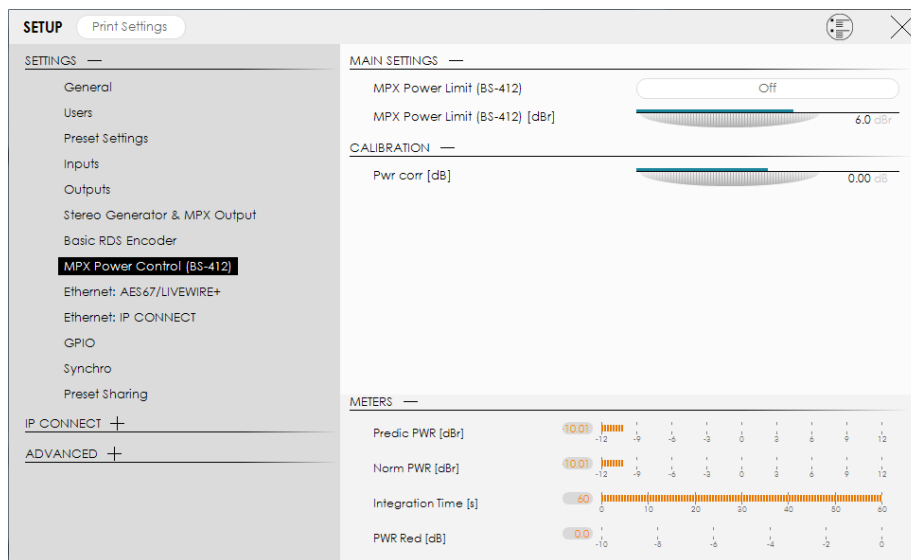

Ethernet: AES67/LIVEWIRE+

Allows basic setup of the Ethernet: AES67/LIVEWIRE+ and displays the current state of the device. You can specify **Network host name**, **DHCP**, **IP Address**, **IP Default Gateway**, **IP Mask**, **IP Broadcast**, **DNS Server** and **DNS Server 2**.

The current values will be displayed below - section **CURRENT**.

The screenshot shows a web-based configuration interface for the Ethernet: AES67/LIVEWIRE+ feature. The interface is divided into several sections:

- SETUP**: Contains a 'Print Settings' button and a navigation menu on the left with options like General, Users, Preset Settings, Voice/Mono Detect, Inputs, Outputs, Stereo Generator & MPX Output, Basic RDS Encoder, MPX Power Control (BS-412), **Ethernet: AES67/LIVEWIRE+** (selected), Ethernet: IP CONNECT, GPIO, Synchro, and Preset Sharing. Below the menu are expandable sections for 'IP CONNECT +' and 'ADVANCED +'.
- BASIC**: Configuration fields for:
 - Network host name: IMPACT-A67-211A0
 - DHCP: On
 - IP Address: [Empty]
 - IP Default Gateway: [Empty]
 - IP Mask: [Empty]
 - IP Broadcast: [Empty]
 - DNS Server: [Empty]
 - DNS Server 2: [Empty]
- CURRENT (DISPLAY ONLY)**: Shows the current status of the network settings:
 - IP Status: Unplug
 - Network host name: IMPACT-A67-211A0
 - IP Address: Error
 - IP Subnet Mask: Error
 - IP Gateway: Error
 - IP Broadcast: Error
 - DNS Server: Unknown
 - DNS Server 2: Unknown

Ethernet: IP CONNECT

All the mandatory IP Connect settings are available in this menu. You can specify **Network host name**, **DHCP**, **IP Address**, **IP Default Gateway**, **IP Mask**, **IP Broadcast**, **DNS Server** and **DNS Server 2**. The current values will be displayed below - section **CURRENT**.

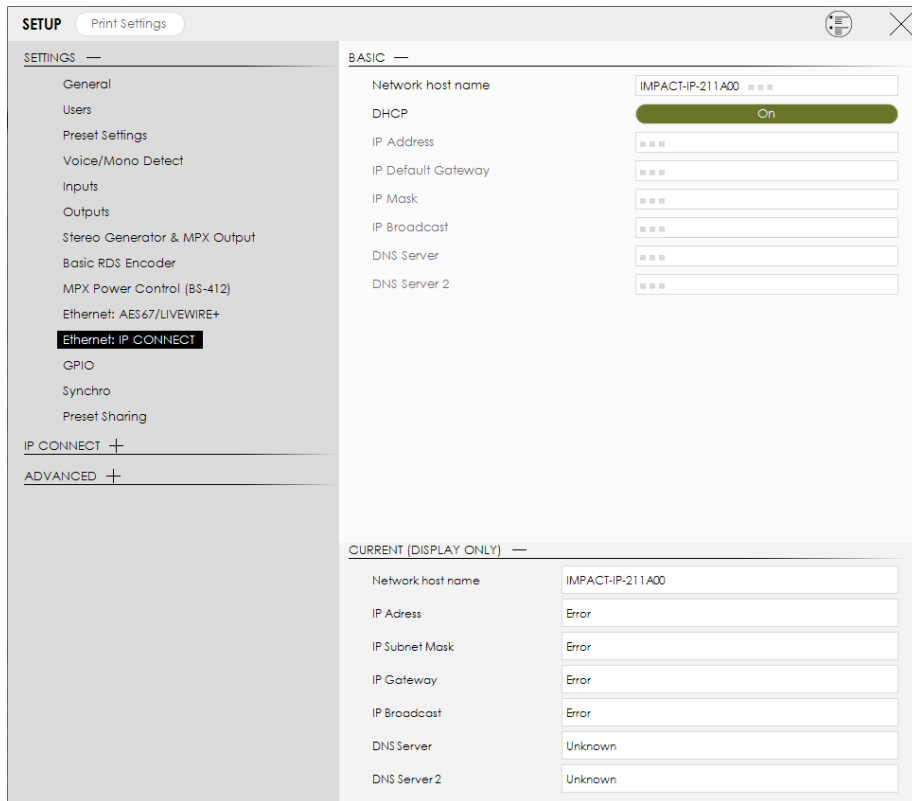

GPIO

The general purpose inputs and outputs settings are applied through this page.

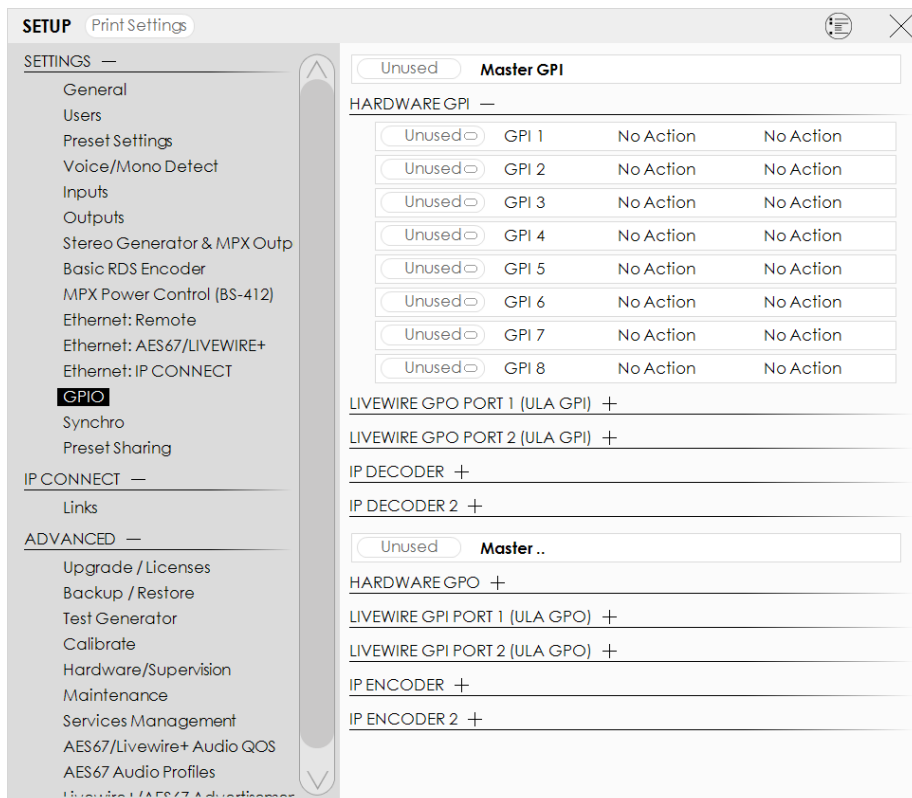

Synchro

All synchronization related settings are available in this section of the Setup menu.

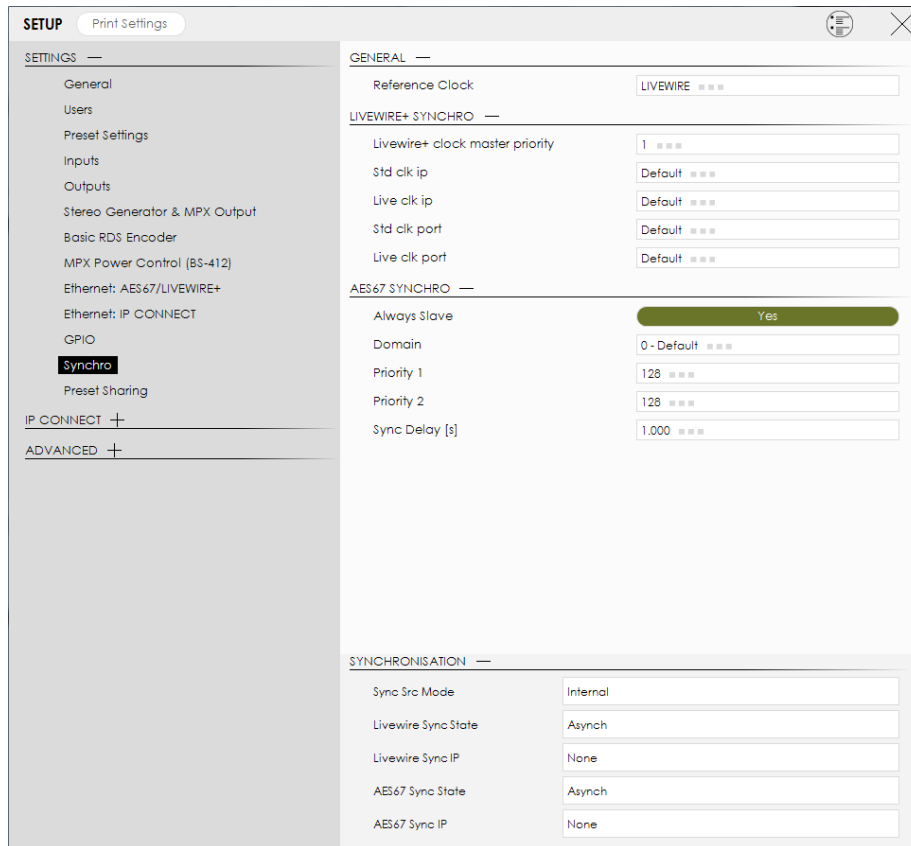

The Reference Clock can be synced either to the LIVEWIRE, Internal or AES67.

LIVEWIRE+ SYNCRO is used to set the Livewire+ clock master priority from the available options. You can also set the Studio (std) and Live clk (clock) ip and port.

AES37 SYNCRO allows you to enable or disable (Yes/No) the Always Slave option. As an addition you can also set the Domain, Priority 1 & 2 and Sync Delay.

SYNCHRONISATION contains information as regards the currently applied settings.

Preset Sharing

A newly created preset can be shared with other devices. All the needed settings for the Preset Sharing option are applied through this menu page.

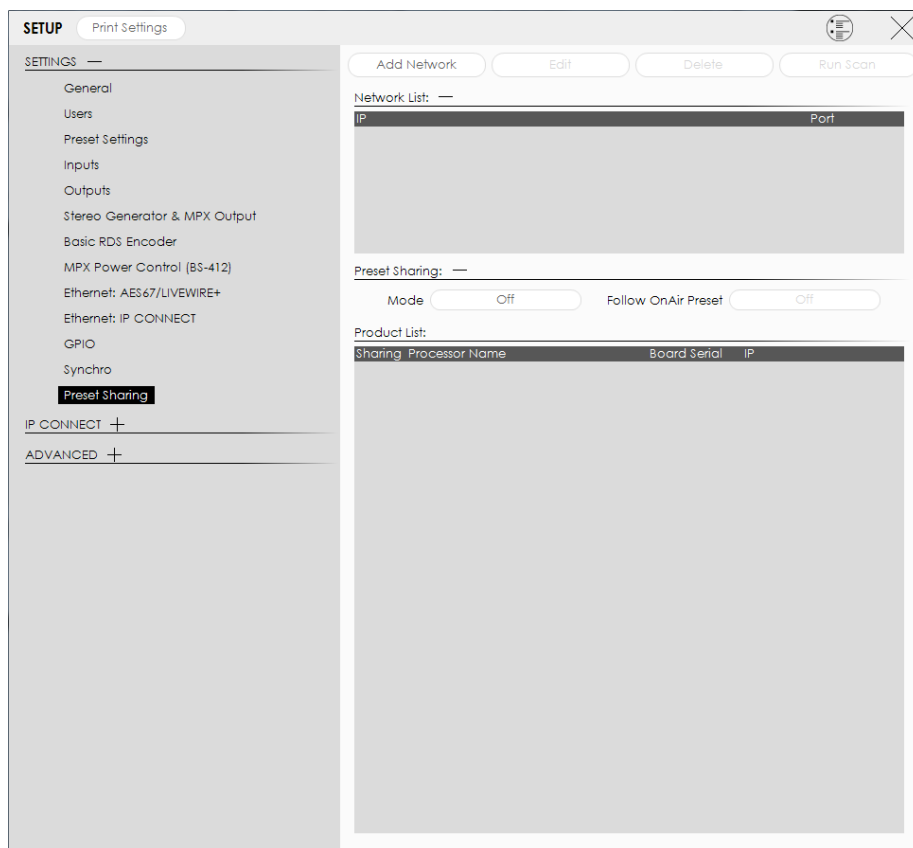

IP Connect

All the IP connect related settings are applied via this menu.

The **Links** menu allows you to specify the number of links to be used.

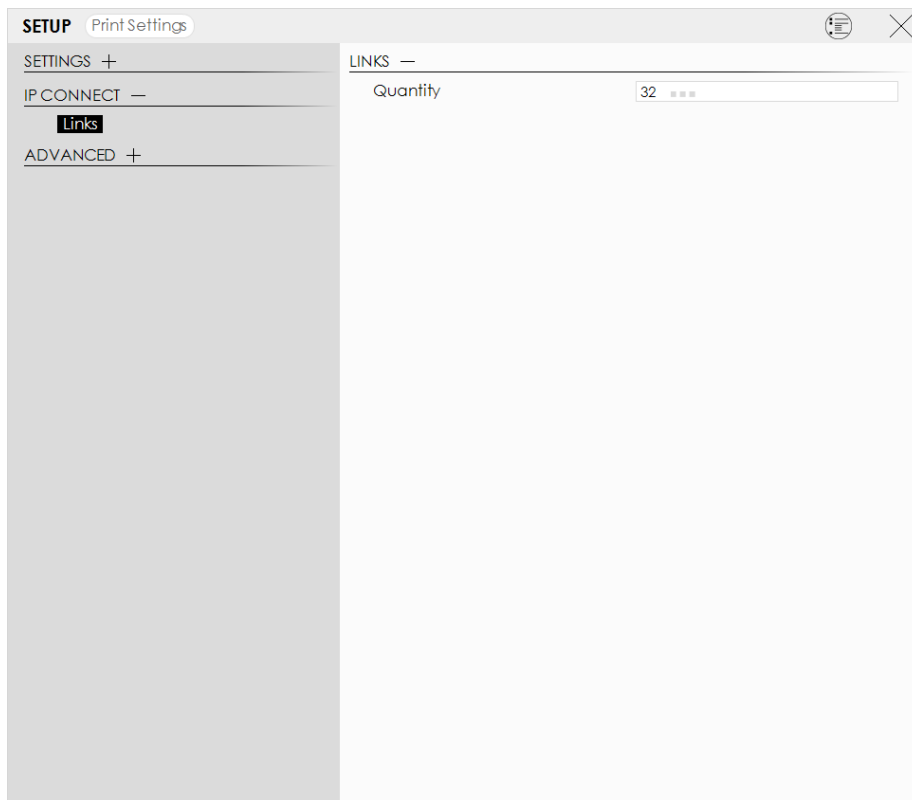

Advanced

Upgrade/License

Allows easy upgrade of the license.

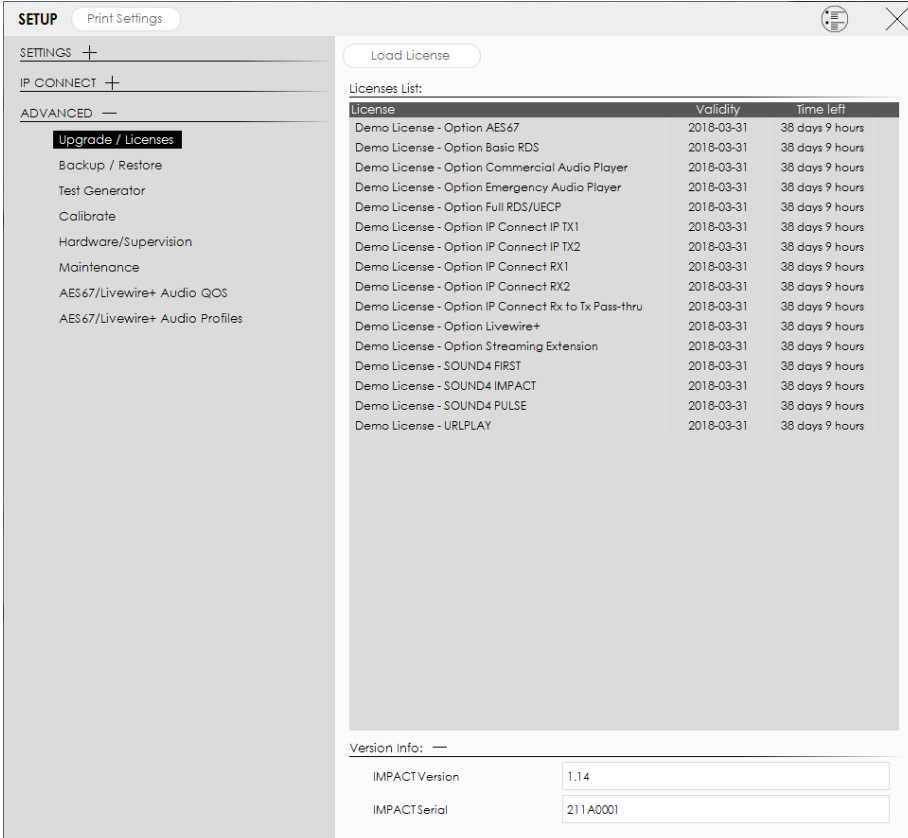

SETUP Print Settings

SETTINGS +

IP CONNECT +

ADVANCED —

Upgrade / Licenses

Backup / Restore

Test Generator

Calibrate

Hardware/Supervision

Maintenance

AES67/Livewire+ Audio QOS

AES67/Livewire+ Audio Profiles

Load License

Licenses List:

License	Validity	Time left
Demo License - Option AES67	2018-03-31	38 days 9 hours
Demo License - Option Basic RDS	2018-03-31	38 days 9 hours
Demo License - Option Commercial Audio Player	2018-03-31	38 days 9 hours
Demo License - Option Emergency Audio Player	2018-03-31	38 days 9 hours
Demo License - Option Full RDS/UECP	2018-03-31	38 days 9 hours
Demo License - Option IP Connect IP TX1	2018-03-31	38 days 9 hours
Demo License - Option IP Connect IP TX2	2018-03-31	38 days 9 hours
Demo License - Option IP Connect RX1	2018-03-31	38 days 9 hours
Demo License - Option IP Connect RX2	2018-03-31	38 days 9 hours
Demo License - Option IP Connect Rx to Tx Pass-thru	2018-03-31	38 days 9 hours
Demo License - Option Livewire+	2018-03-31	38 days 9 hours
Demo License - Option Streaming Extension	2018-03-31	38 days 9 hours
Demo License - SOUND4 FIRST	2018-03-31	38 days 9 hours
Demo License - SOUND4 IMPACT	2018-03-31	38 days 9 hours
Demo License - SOUND4 PULSE	2018-03-31	38 days 9 hours
Demo License - URLPLAY	2018-03-31	38 days 9 hours

Version Info: —

IMPACT Version: 1.14

IMPACT Serial: 211A0001

There are two options of loading a new license/s. Both are explained in details below.

Option 1 – Expired License

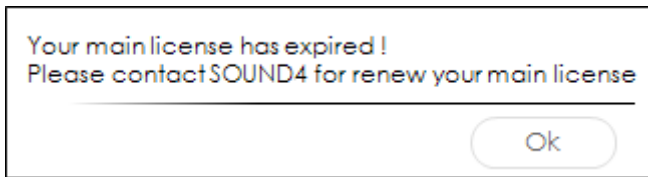

Please contact our representative in your region or our sales office if you need to obtain new license. To upload a new license follow the steps listed below:

1. Press [OK]. The following screen will appear;

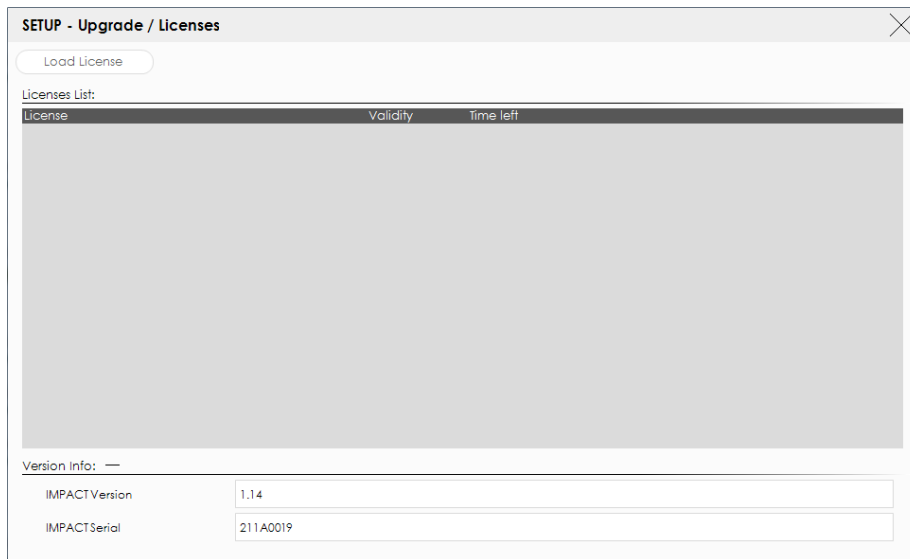

2. Press [License upload] and a new window requiring license file to be selected will open;
3. Go to the file directory, select the license and press [Open].
NOTE: All licenses are sent/provided in a ZIP file. It is not needed the file to be unzipped prior to their upload. They will be accepted by the program as they are.
4. Wait until the licenses are loaded;



5. Once the process is completed, the following message will appear:

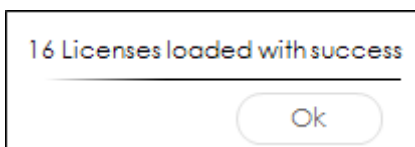

6. Press [OK] and the Main control window will appear.

Option 2 – NEW License

1. Open the Main control window and click on [Setup]. The setup menu will appear;
2. Scroll down with the cursor to the ADVANCED settings and press Upgrade Licenses. The Following window will appear:

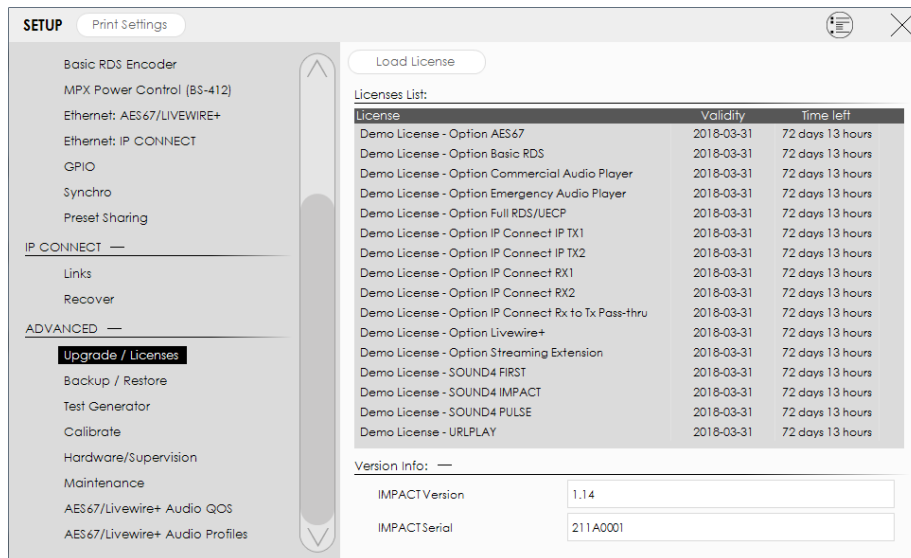

3. Press [Load Licenses];
4. Go to the file directory, select the license and press [Open].
NOTE: All licenses are sent/provided in a ZIP file. It is not needed the file to be unzipped prior to their upload. They will be accepted by the program as they are.
5. Wait while the licenses are loaded;
6. Once the process is completed, press [OK] and close the Setup window so that the Main control can appear.

Backup/Restore

This section is dedicated to the Backup, Restore and Restore to Factory processes. To ease the completion of each option, thorough information as regards each opportunity can be found in the right part of the screen.

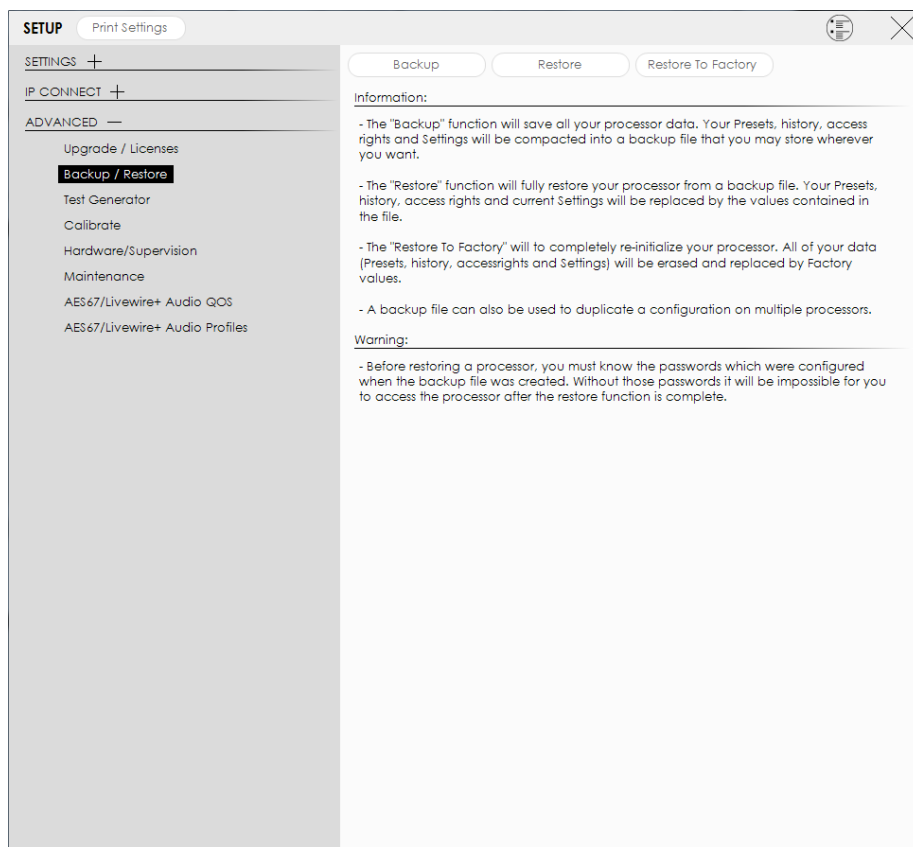

Test Generator

All the mandatory settings for the Test Generator are available here.

Generator Mode – can be turned [On] or [Off];

You can also set the desired **Amplitude** in %, the **Fine level adjustment** in db and **Frequency** in Hz. As an addition you can select the desired **Wave** type and using the interactive slider to set the **Nb Harmoniques**. The following parameters are also user-selectable - **No process**, **Filter**, **Phase**, **Left only**, **Right only**, **Left -6dB** and **Right -6dB**.

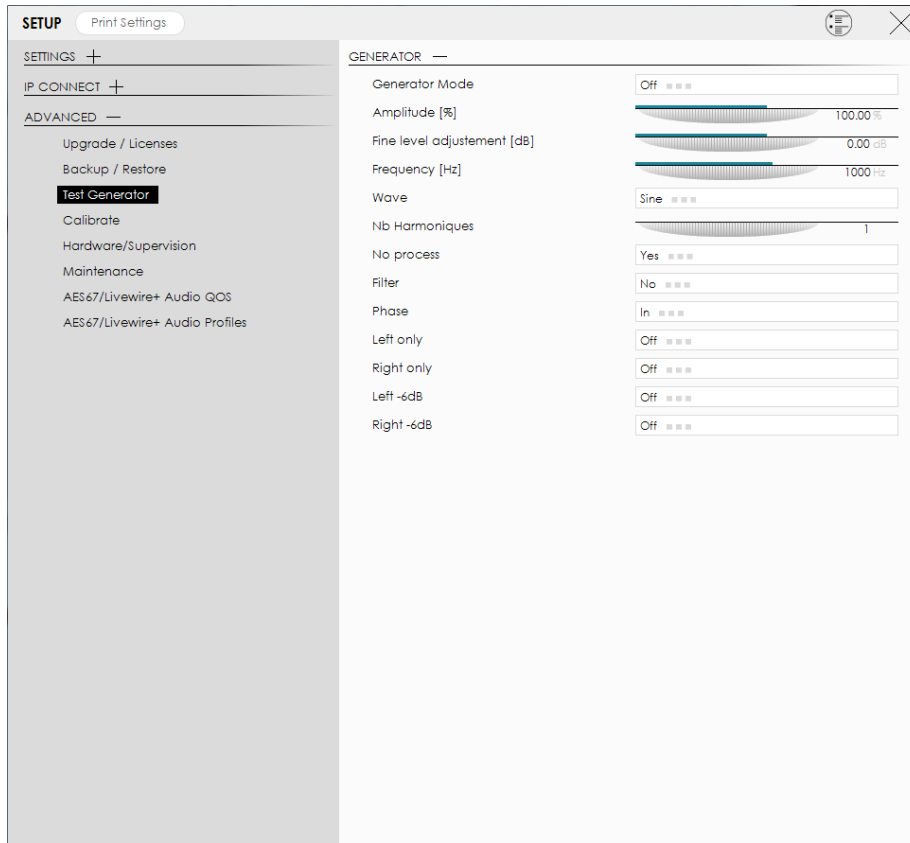

Calibrate

To calibrate the device, follow the process by applying the needed settings and clicking [Next] on each tab until the procedure is completed. The software will guide you through the Calibration process.

CALIBRATE



You will need a meter with assymetrical (for TX) and symmetrical (for Analog output) inputs.
You will also need a pair of symetrical XLR cable for linking analog output to input,
You will also need a pair of assymetrical BNC cable for linking TX to Sub,
Don't do this if you are on air.

 Sine waves will be output to all I/O.

 Clicking 'Next' button will enter in calibrate mode.
Clicking 'Restore Factory Calibration' button will restore Factory Calibration.

Restore Factory Calibration

Next Cancel

Hardware/Supervision

Allows set-up of the **Display**, **SNMP** and **Windows share** options. This section also provide all the needed information for the **Temperature**, **Main CPU Usage** and **FAN**.

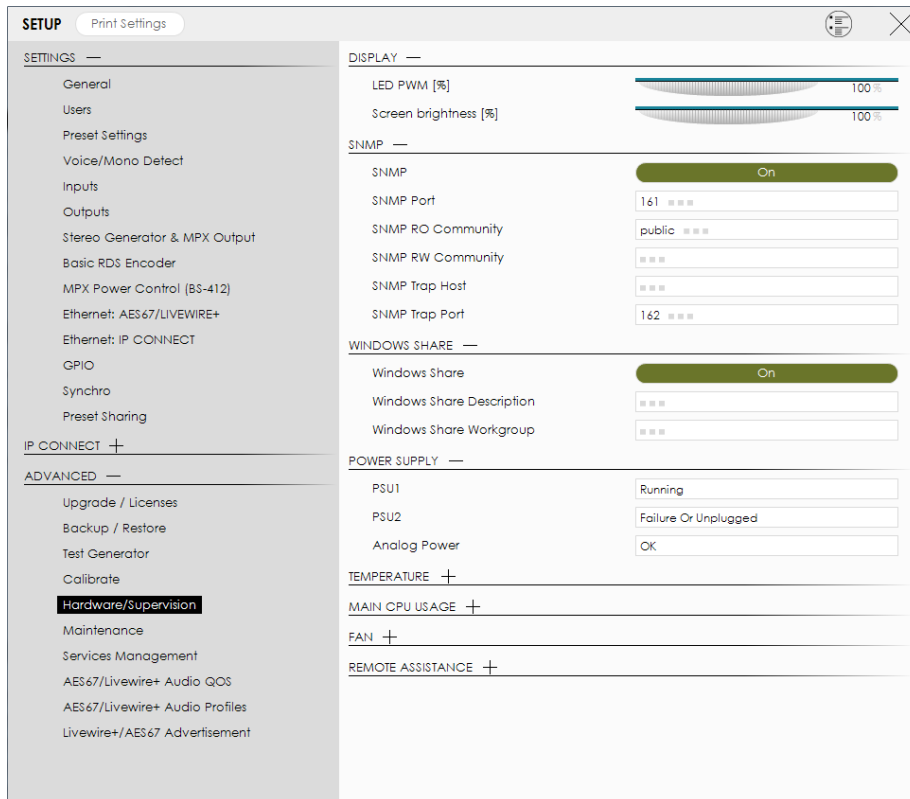

Display – set the desired LED PWM (power meters) and Screen brightness in %.

SNMP – turn the option [ON] or [Off] and specify SNMP Port, SNMP RO Community, SNMP RW Community, SNMP Trap Host and SNMP Trap Port.

Windows Share – turn the option [ON] or [Off] and specify Windows Share description and Windows Share Workgroup.

Power Supply – displays the current status of the PSU1 and PSU2 and Analog Power.

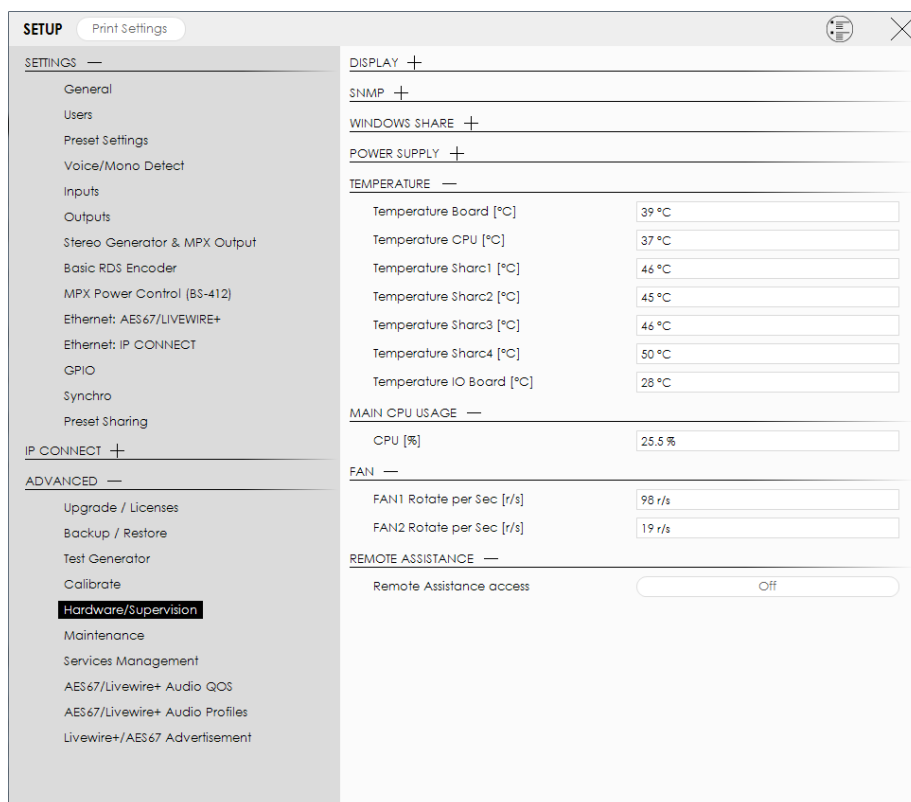

Temperature – displays the current temperature (in Celsius) of the Board, CPU, Sharc1 to 4 and IO Board.

Main CPU usage – displays the current CPU usage in %.

Fan – displays the current status of FAN 1 & 2 in rotations per second.

If **Remote Assistance** is needed, the option can be turned [On] or [Off].

Maintenance

Information as regards the available options can be found in the right part of the screen. Upon selecting any of the reset options, a warning message will appear. To continue with the process, press OK.

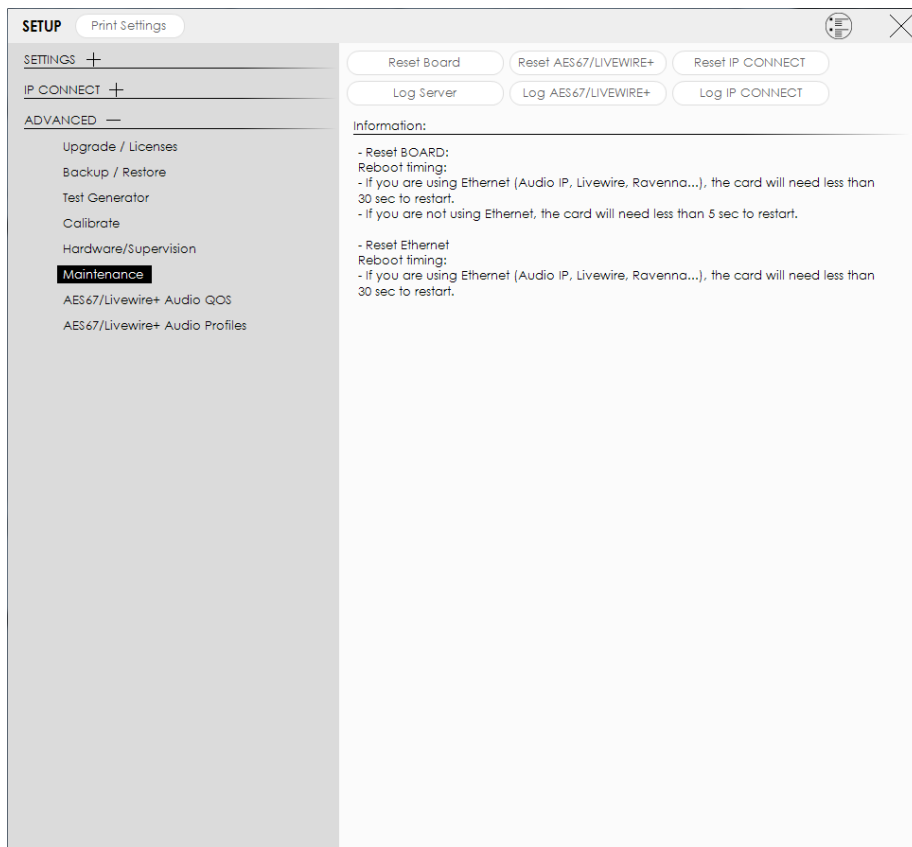

AES67/Livewire+Audio QOS

All the mandatory settings to be applied to the AES67/Livewire+Audio QOS are available in this section of the menu.

The screenshot shows the 'SETUP' window with the 'ADVANCED' section expanded. The 'AES67/Livewire+ Audio QOS' option is selected in the left sidebar. The main panel displays the following settings for 'LIVEWIRE+ QOS (802.1P 802.1Q) / LIVE AUDIO':

- Receive Buffer Size [ms]: LIVEWIRE+ QOS (802.1p 802.1Q) / LIVE AUDIO
- 802.1 Tagging: On
- 802.1 VLAN ID: 0
- 802.1 Priority: 6 Internetwork Control (recommended)
- DSCP Class of Service: 46 Expedited Forwarding (recommended)
- Time To Live (TTL): 2

Below this, settings for 'LIVEWIRE+ QOS (802.1P 802.1Q) / STANDARD AUDIO' are shown:

- Receive Buffer Size [ms]: 100.00
- 802.1 Tagging: On
- 802.1 VLAN ID: 0
- 802.1 Priority: 5 Voice, 10 ms latency (recommended)
- DSCP Class of Service: 34 AF41 (recommended)
- Time To Live (TTL): 2

Other QoS profiles are listed but collapsed:

- AES67 QOS (802.1P 802.1Q) / VERY LOW DELAY
- AES67 QOS (802.1P 802.1Q) / LOW DELAY
- AES67 QOS (802.1P 802.1Q) / STANDARD
- AES67 QOS (802.1P 802.1Q) / PTP

The screenshot shows the 'SETUP' window with the 'ADVANCED' section expanded. The 'AES67/Livewire+ Audio QOS' option is selected in the left sidebar. The main panel displays the following settings for 'AES67 QOS (802.1P 802.1Q) / LOW DELAY':

- Receive Buffer Size [ms]: 5.00
- 802.1 Tagging: Off
- 802.1 VLAN ID: 0
- 802.1 Priority: 5 Voice, 10 ms latency (recommended)
- DSCP Class of Service: 34 AF41 (recommended)
- Time To Live (TTL): 2

Below this, settings for 'AES67 QOS (802.1P 802.1Q) / STANDARD' are shown:

- Receive Buffer Size [ms]: 50.00
- 802.1 Tagging: Off
- 802.1 VLAN ID: 0
- 802.1 Priority: 5 Voice, 10 ms latency (recommended)
- DSCP Class of Service: 34 AF41 (recommended)
- Time To Live (TTL): 2

Other QoS profiles are listed but collapsed:

- AES67 QOS (802.1P 802.1Q) / VERY LOW DELAY
- AES67 QOS (802.1P 802.1Q) / PTP

AES67/Livewire+Audio Profiles

All the mandatory settings to be applied to the AES67/Livewire+Audio Profiles are available in this section of the menu.

The screenshot shows a software configuration window titled "SETUP" with a "Print Settings" button. The left sidebar contains a menu with the following items: "SETTINGS +", "IP CONNECT +", "ADVANCED -", "Upgrade / Licenses", "Backup / Restore", "Test Generator", "Calibrate", "Hardware/Supervision", "Maintenance", "AES67/Livewire+ Audio QOS", and "AES67/Livewire+ Audio Profiles" (which is highlighted). The main area displays three profile configurations:

Profile Name	Sample Format	Packet Len
AES67 PROFILE / VERY LOW DELAY	L24	12
AES67 PROFILE / LOW DELAY	L24	48
AES67 PROFILE / STANDARD	L24	120

Livewire+/AES67 Advertisement

This section allows you to turn [On] or [Off] the Livewire, MDNS and SAP Dante advertisement option.

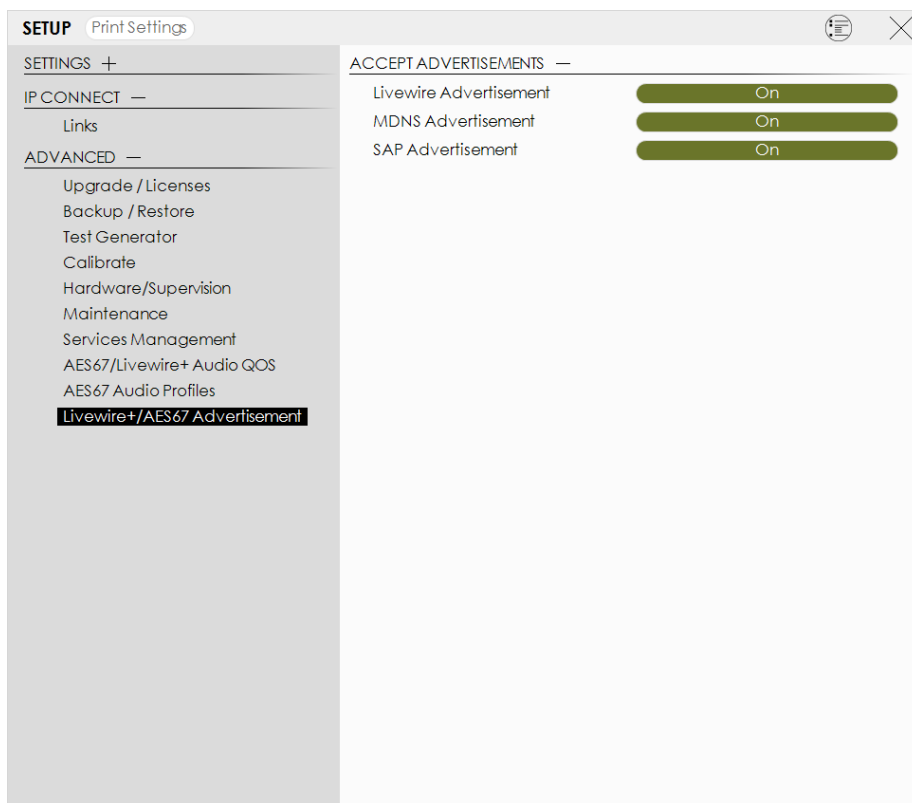

WARRANTY TERMS AND CONDITIONS

I. TERMS OF SALE: SOUND4 Ltd. products are sold with an understanding of “full satisfaction”; that is, full credit or refund will be issued for products sold as new if returned to the point of purchase within 30 days following their receipt, provided that they are returned complete and in an “as received” condition.

II. CONDITIONS OF WARRANTY: The following terms apply unless amended in writing by SOUND4 Ltd.

A. The Warranty Registration Card supplied with this product must be completed and returned to SOUND4 Ltd. within 10 days of delivery.

B. This Warranty applies only to products sold “as new.” It is extended only to the original end-user and may not be transferred or assigned without prior written approval by SOUND4 Ltd.

C. This Warranty does not apply to damage caused by improper mains settings and/or power supply.

D. This Warranty does not apply to damage caused by misuse, abuse, accident or neglect. This Warranty is voided by unauthorized attempts at repair or modification, or if the serial identification label has been removed or altered.

III. TERMS OF WARRANTY: SOUND4 Ltd. products are warranted to be free from defects in materials and workmanship.

A. Any discrepancies noted within FIVE YEARS of the date of delivery will be repaired free of charge, or the equipment will be replaced with a new or remanufactured product at SOUND4 Ltd. option.

B. Parts and labor for factory repair required after the five-year Warranty period will be billed at prevailing prices and rates.

IV. RETURNING GOODS FOR FACTORY REPAIR:

A. Equipment will not be accepted for Warranty or other repair without a Return Authorization (RA) number issued by SOUND4 Ltd. prior to its return. An RA number may be obtained by calling the factory. The number should be prominently marked on the outside of the shipping carton.

B. Equipment must be shipped prepaid to SOUND4 Ltd.. Shipping charges will be reimbursed for valid Warranty claims. Damage sustained as a result of improper packing for return to the factory is not covered under terms of the Warranty and may occasion additional charges.

Please print, complete and sign this Product Registration Card, and send to the following address:
Sound4 Ltd, 65, Al. Stamboliyski Str. 8000 Burgas, Bulgaria.
Or scan and e-mail to support@sound4.com to register your product.

PRODUCT REGISTRATION CARD

- All fields are required, or warranty registration is invalid and void

Your Company Name _____

Contact _____

Address Line 1 _____

Address Line 2 _____

City _____

State/Province _____ ZIP/Postal Code _____

Country _____

E-mail _____ Phone _____ Fax _____

Which SOUND4 Ltd. product did you purchase? _____

Product Serial # _____

Purchase date ____ / ____ / ____

Installation date ____ / ____ / ____

Your signature*

*Signing this warranty registration form you are stating that all the information provided to SOUND4 Ltd. are truth and correct. SOUND4 Ltd. declines any responsibility for the provided information that could result in an immediate loss of warranty for the above specified product(s).

Privacy statement: SOUND4 Ltd. will not share the personal information you provide on this card with any other parties.